

SURGICAL

Instruments Catalogue



www.baileysurgico.com



BAILEY BROTHERS SURGICO

P.O.Box - 1953, Ismailabad, Pacca Garha, Sialkot - Pakistan.

Ph: +92-52-4263412 Fax: +92-52-4264603

E-mail: info@baileysurgico.com



Manufacturers & Exporters Of Quality Surgical, Dental & Beauty Care Instruments



INTRODUCTION



We present this CATALOGUE with a hope that it would be an excellent guide to all over promoters and Surgical professionals the world over.

We endeavor to present in this CATALOGUE a modern range of instruments to the trade and medical professionals in order to achieve the highest result.

We are the located in the center of the city which is known the world over for this profession having at our disposal expert crafted whose skilled technique and traditional approach towards modern surgery makes all the possibilities to acclaim us quality instruments producers.

We are grateful for the loyal support given to us by our promoters who have been selling our Stainless Steel Surgical Instruments in their market with pride and honor.

We pledge to serve more in the years ahead to our quality minded promoters with much more higher standard and correct design of the instruments.

We also welcome our enquiries for the instruments not listed in This CATALOGUE both in Surgical instruments.

It is our earnest desire to maintain our present price but due to the present universal economic condition which are beyond our control, all prices are subjected to change without any notice.





No.3L
A1-00101



ERGONOMIC
A1-00102



No.7
A1-00103



SURGICAL HANDLES



A2-00104



A2-00105



A2-00106



No.4
A3-00107



No.9
A3-00108



No. 3
A3-00109



SURGICAL HANDLES

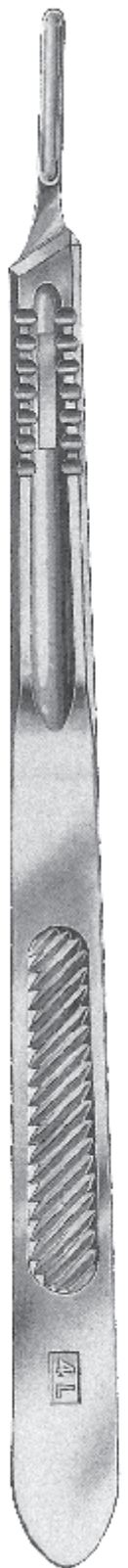

No.4L
 A4-00110



No.10
 A4-00111



BARRON
 A4-00112
 For "B.P." type blades
 for use with No's 10,11,12 & 15 blades
 135mm (5.1/4")

■■■■■
STERILE BLADES ■■■■



A5-00113



A5-00114



A5-00115



A5-00116



A5-00117



A5-00118



A5-00119



A5-00120



A5-00121



STERILE BLADES



A6-00122



A6-00123



A6-00124



A6-00125



A6-00126



A6-00127



A6-00128

All Blades are sold in dispenser packs of 100
Sterile



SKIN GRAFTING KNIVES



SILVER

A7-00129
 Skin Graft Knife
 without blade
 190mm (7.1/2")

Bar fixed

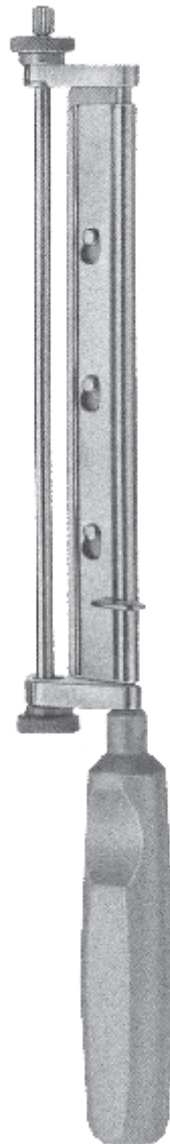

WATSON

A7-00130
 Skin Graft Knife
 without blade
 300mm (12")

Bar only oscillating

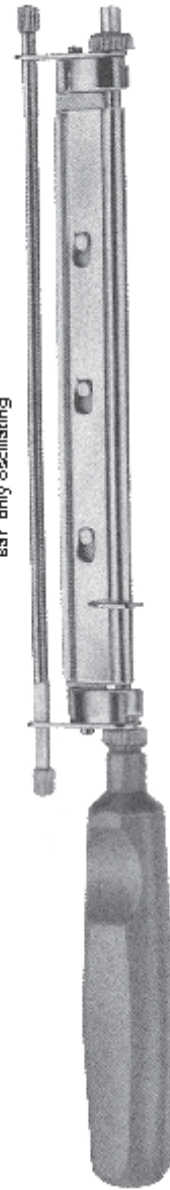

COBBETT

A7-00131
 Skin Graft Knife
 without blade
 315mm (12.2/3")

SKIN GRAFTING KNIVES

Bar oscillating and rotating

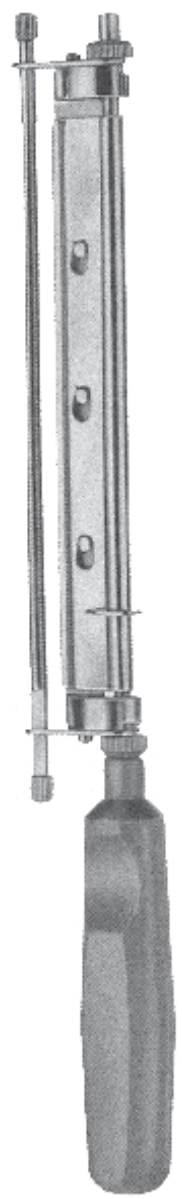

BRAITHWAITE
A8-00132
 Skin Graft Knife
 without blade
 315mm (12.2/3")

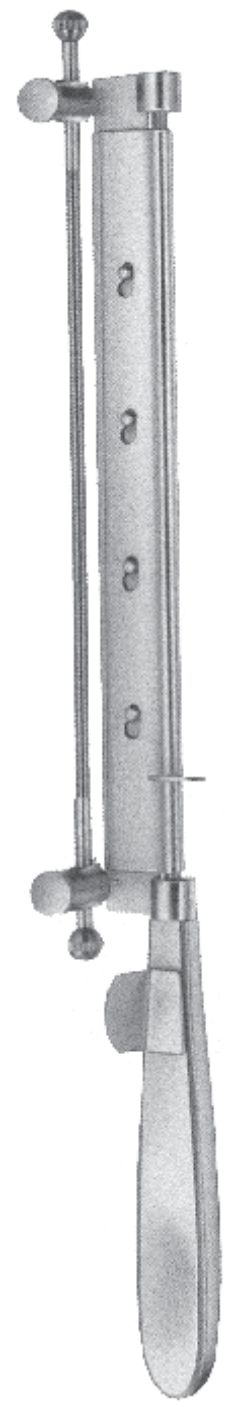

HUMBY
A8-00133
 Skin Graft Knife
 without blade
 365mm (13.3/4")

SCISSORS



MAYO
 Straight, bevelled blades



B1-01100
 140 mm
 (5.1/2")

B1-01102
 190 mm
 (7.1/2")



B1-01101
 170 mm
 (6.3/4")

B1-01103
 215mm
 (8.1/2")



B1-01104
 140 mm
 (5.1/2")

B1-01106
 190 mm
 (7.1/2")



B1-01105
 170 mm
 (6.3/4")

B1-01107
 215mm
 (8.1/2")

Curved on flat, bevelled blades



MAYO
 Round Blades



B1-01108
 170 mm
 (6.3/4")

200mm
 (8")
 Straight



B1-01109
 140mm
 (5.1/2")

150 mm
 (6")
 Straight



MAYO
 Round Blades



B1-01110
 170 mm
 (6.3/4")

200mm
 (8")
 Curved on flat



B1-01111
 140mm
 (5.1/2")

150 mm
 (6")
 Curved on flat



SCISSORS

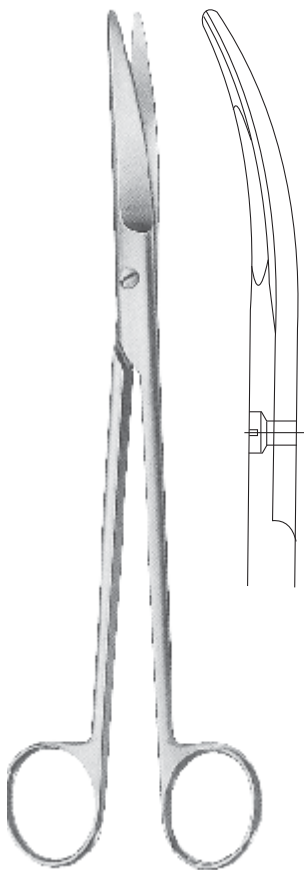

MAYO HARRINGTON
B2-01112
225mm (9")
Curved on flat , blunt points

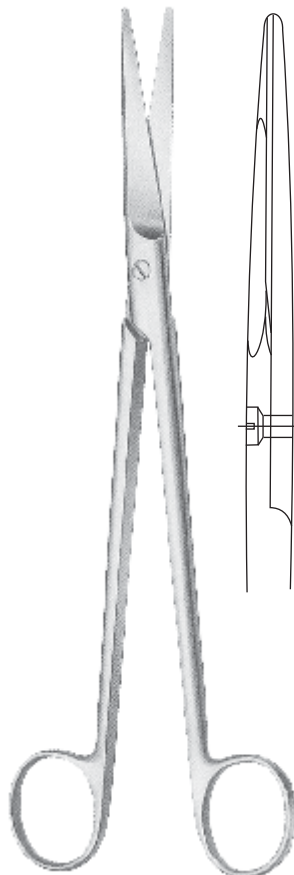

MAYO HARRINGTON
B2-01113
225mm (9")
Straight, blunt points

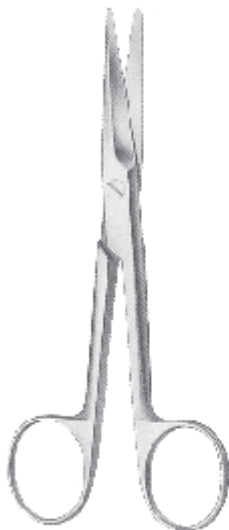

MAYO (STILLE)



B2-01114
170 mm
(6.3/4")
Straight



B2-01115
150 mm
(6")
Straight



B2-01116
170 mm
(6.3/4")
Curved on
flate



B2-01117
150 mm
(6")
Curved on
flate



SCISSORS



METZENBAUM

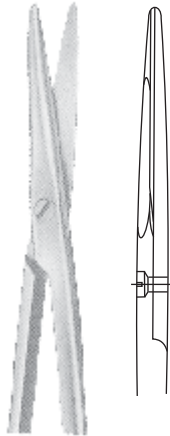

METZENBAUM
 Straight, blunt points

B3-01118
 115mm (4.1/2")

B3-01119
 145mm (5.3/4")

B3-01120
 180mm (7")

B3-01121
 200mm (8")

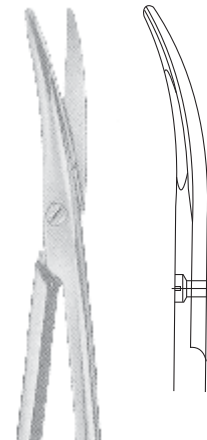

METZENBAUM
 Curved on flat, blunt points

B3-01124
 115mm (4.1/2")

B3-01125
 145mm (5.3/4")

B3-01126
 180mm (7")

B3-01127
 200mm (8")

METZENBAUM (Nelson)
 Straight

B3-01122
 230mm (9")

B3-01123
 250mm (10")

METZENBAUM (Nelson)
 Curved on flat

B3-01128
 230mm (9")

B3-01129
 250mm (10")



SCISSORS

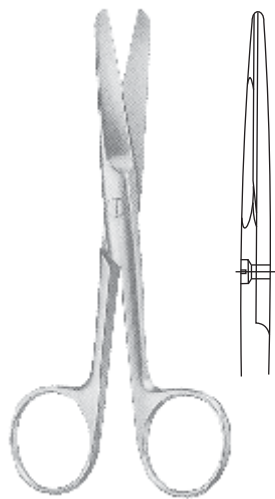

DRESSING
Straight, blunt / blunt points

B4-01134
125mm (5")

B4-01135
145mm (5.3/4")

B4-01136
150mm (6")

B4-01137
180mm ((7")

B4-01138
200mm (8")

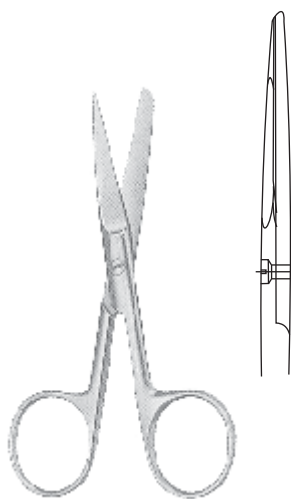

DRESSING
Straight, sharp / blunt points

B4-01139
125mm (5")

B4-01140
145mm (5.3/4")

B4-01141
150mm (6")

B4-01142
180mm ((7")

B4-01143
200mm (8")

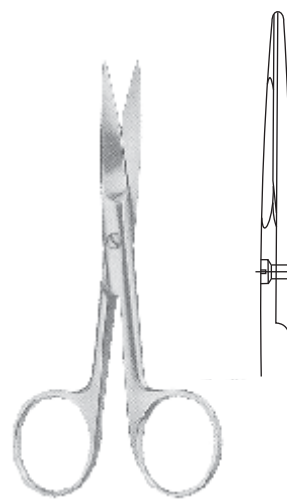

DRESSING
Straight, sharp / Sharp points

B4-01144
125mm (5")

B4-01145
145mm (5.3/4")

B4-01146
150mm (6")

B4-01147
180mm (7")

B4-01148
200mm (8")



SCISSORS

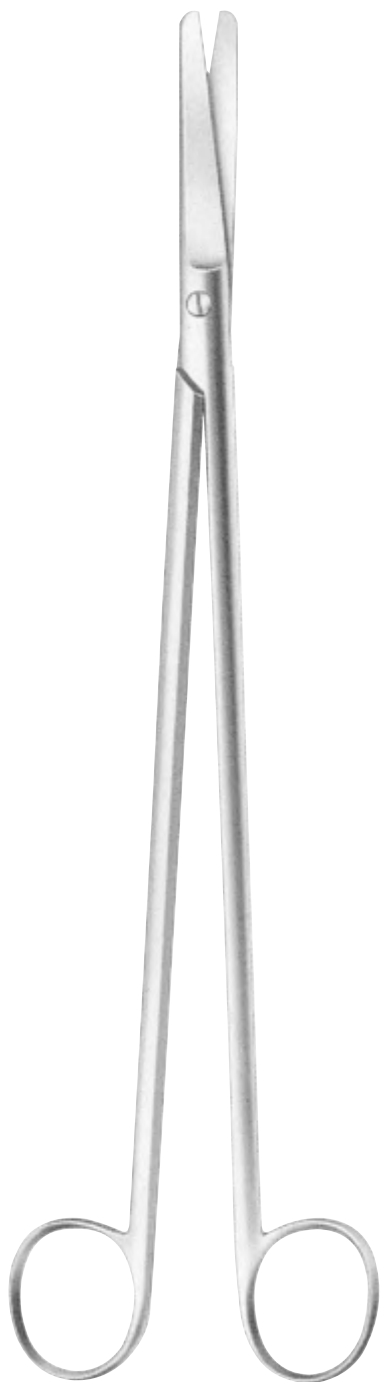

CRAFOORD

B5-01149
 305mm (12")
 Straight

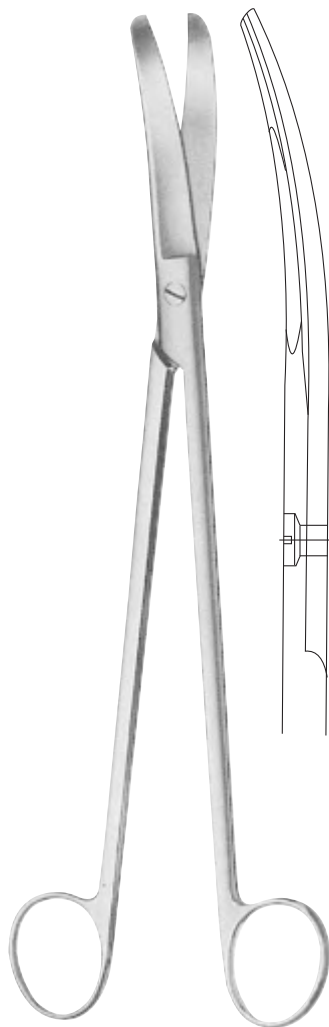

LLOYD DAVIS RECTAL
 blunt points, flat blades

B5-01150
 255mm (10")
 Curved on flat
B5-01151
 255mm (10")
 Straight

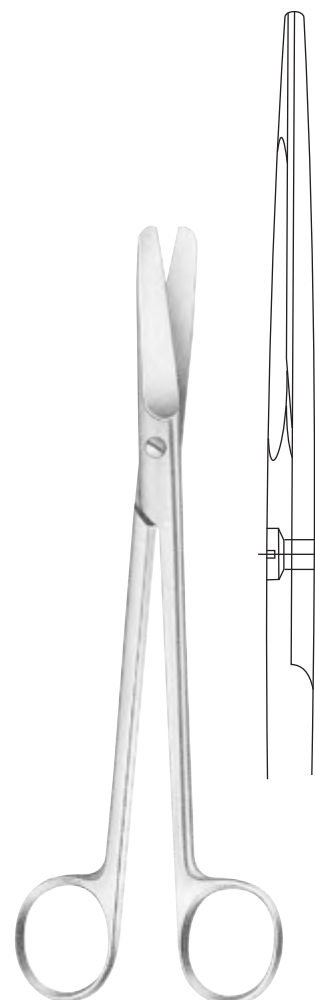

UTERINE

B5-01152
 230mm (9")
 Straight. blunt points



SCISSORS

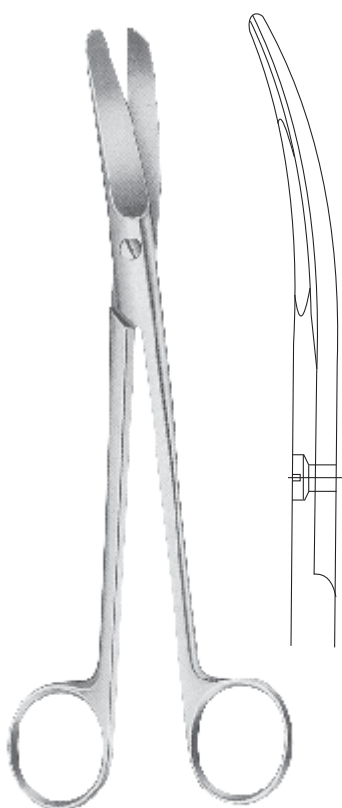

UTERINE
Curved on flat, blunt points

B6-01153
200mm (8")

B6-01154
230mm (9")



**BRAUN STADTLER
EPISIOTOMY**
Angled blades

B6-01155
145mm (5.3/4)

B6-01156
200mm (8")



**AMERICAN PATTERN
UMBILICAL**
Angled blades

B6-01157
100mm (4")



SCISSORS

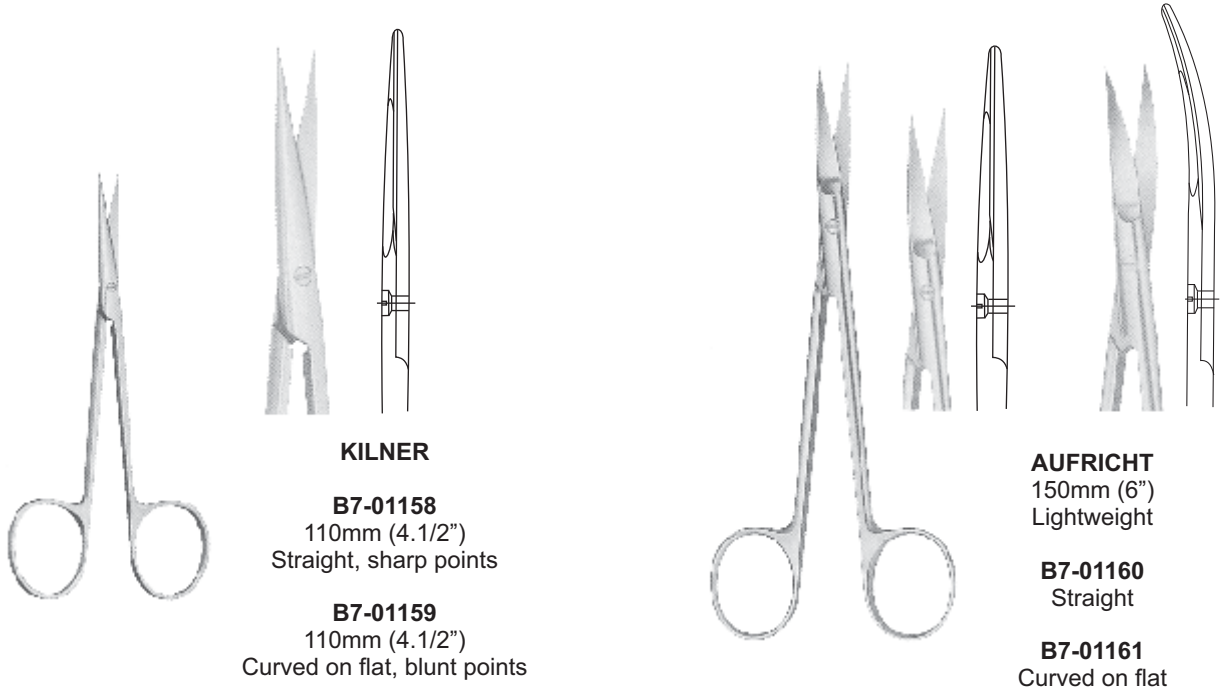

KILNER

B7-01158
 110mm (4.1/2")
 Straight, sharp points

B7-01159
 110mm (4.1/2")
 Curved on flat, blunt points

AUFRICHT
 150mm (6")
 Lightweight

B7-01160
 Straight

B7-01161
 Curved on flat

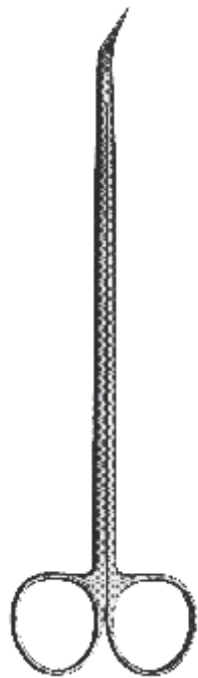

HEGEMANN'S DELICATE
 190mm (7.1/2")

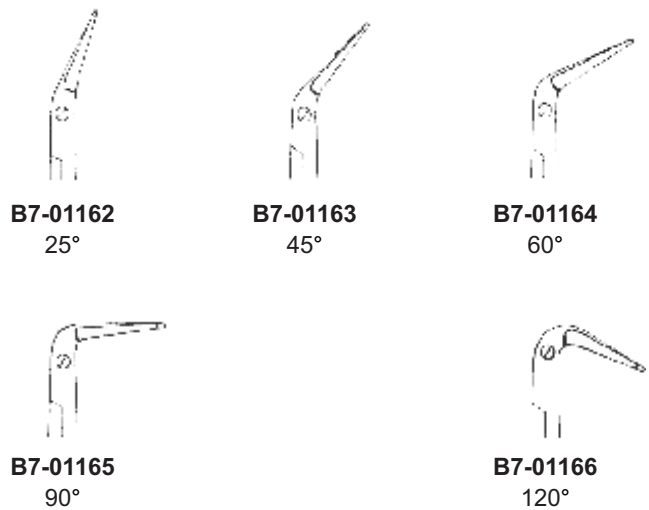

B7-01162
 25°

B7-01163
 45°

B7-01164
 60°

B7-01165
 90°

B7-01166
 120°

DELICATE SCISSORS

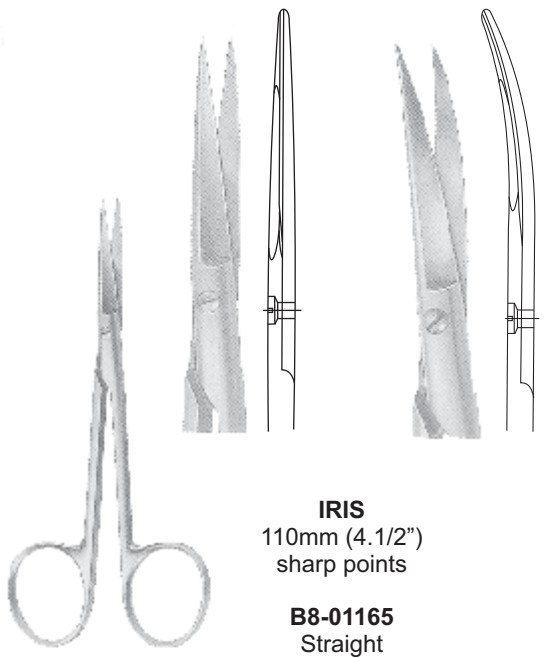

IRIS
 110mm (4.1/2")
 sharp points
B8-01165
 Straight

B8-01166
 Curved on flat

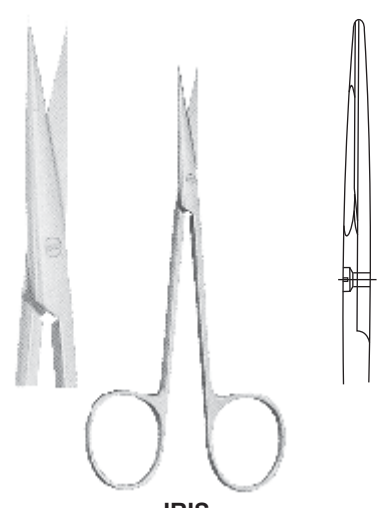

IRIS
 110mm (4.1/2")
 Round blades, sharp points

B8-01167
 Straight

B8-01168
 Curved on flat

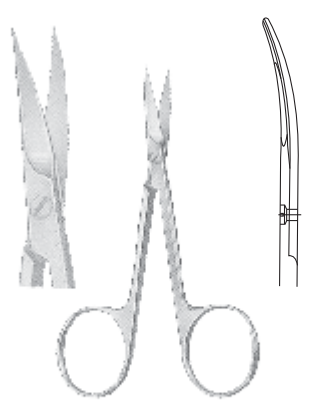

IRIS
B8-01169
 90mm (3.1/2")
 Curved on flat, lightweight
 sharp points

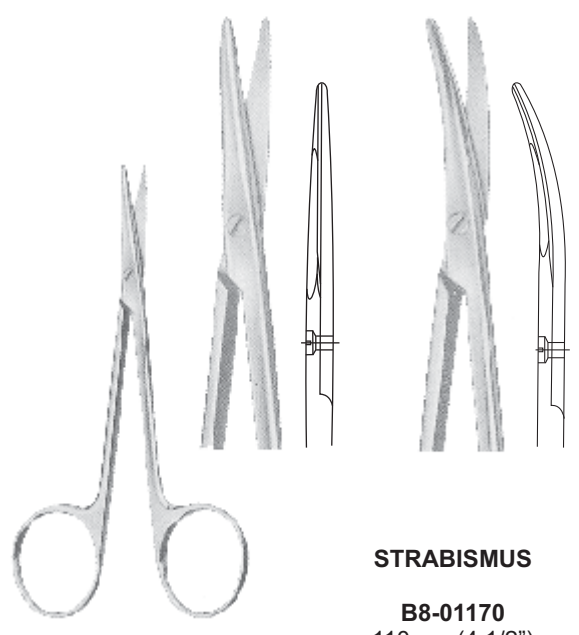

STRABISMUS

B8-01170
 110mm (4.1/2")
 Straight

B8-01171
 110mm (4.1/2")
 Curved on flat

DELICATE SCISSORS

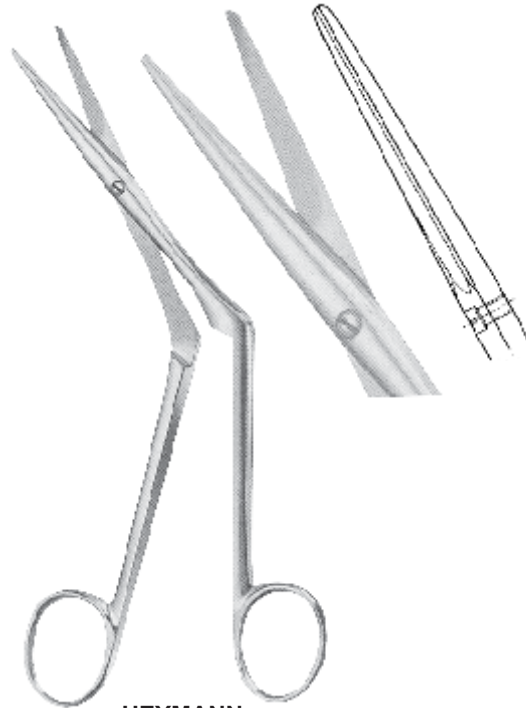

**HEYMANN
 TURBINECTOMY**

B9-01172
 185mm (7.1/4")
 Angled shanks
 blunt points

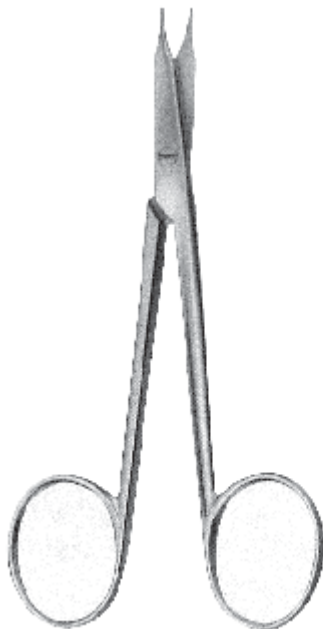

STEVENS TENOTOMY
 110 mm (4.1/4")

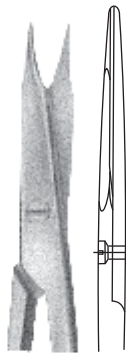

B9-01173
 straight,
 sharp points

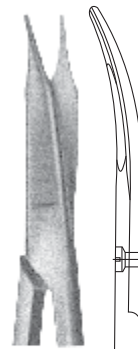

B9-01174
 Curved on flat
 sharp points

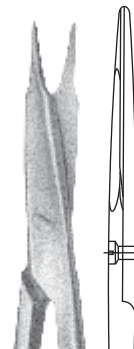

B9-01175
 straight,
 blunt points

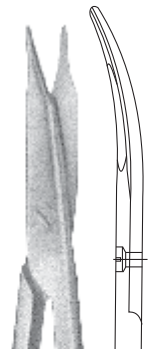

B9-01176
 Curved on flat
 blunt points



ORAL SCISSORS

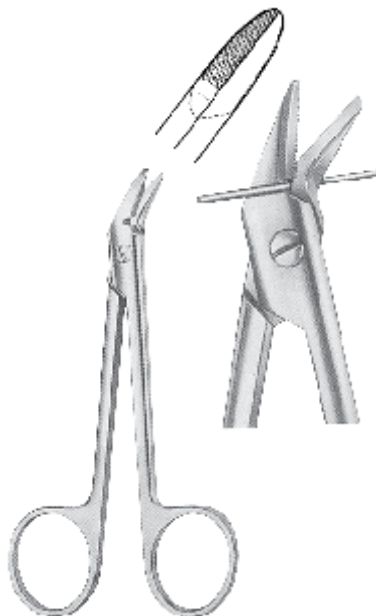

**SCHUKNECHT
WIRE CUTTING**

B10-01177
125mm (5")



WOODS TONSIL

B10-01178
190mm (7.1/2")
Curved on flat
sharpened
outer edge, blunt

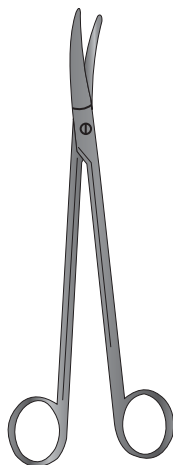

WHEELER TONSIL

B10-01179
200mm (8")
Curved on flat

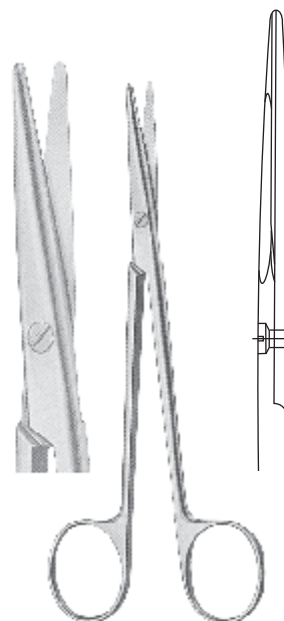

WILSON TONSIL

B10-01180
180mm (7")
Straight



SCISSORS



POTTS

- B12-01186**
190mm (7.1/2")
Angled on flat 45 degrees
- B12-01187**
190mm (7.1/2")
Angled on side 25 degrees
- B12-01188**
190mm (7.1/2")
Angled on side 45 degrees



HEDGEMAN (DIETRICH)

- B12-01189**
175mm (7")
Angled to side, 25 degrees
- B12- 01190**
175mm (7")
Angled to side, 45 degrees
- B12-01191**
175mm (7")
Angled to side, 60 degrees
- B12-01192**
175mm (7")
Angled to side, 90 degrees
- B12-01193**
175mm (7")
Angled to side, 125 degrees



FAVALORO

- B12-01194**
150mm (6")
Shanks curved,
blades angled to side



SCISSORS



REYNOLDS
Curved on flat, tapered points

B13-01195
145mm (5.3/4")

B13-01196
180mm (7")

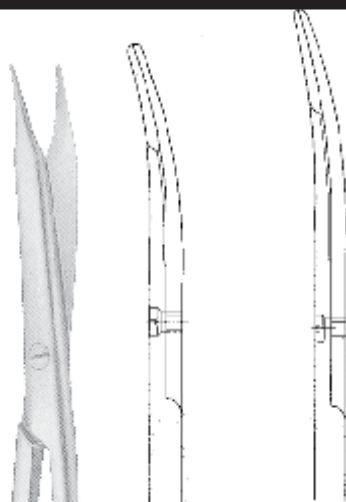

DOYEN ABDOMINAL

B13-01197
180mm (7")
Curved, blunt points

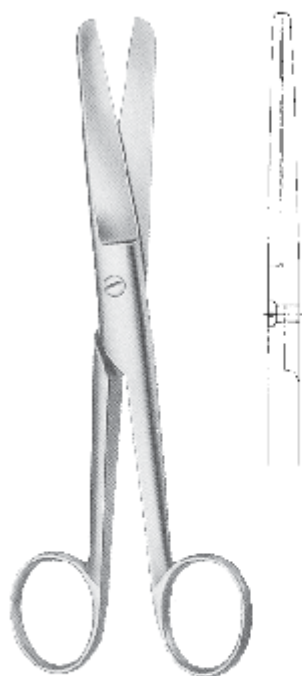

DOYEN ABDOMINAL

B13 -01198
180mm (7")
Straight, blunt points



DOYEN ABDOMINAL

B13-01199
210mm (8.1/4")
One blade with hook end

COUNTER SCISSORS

B13-01200
210mm (8.1/4")

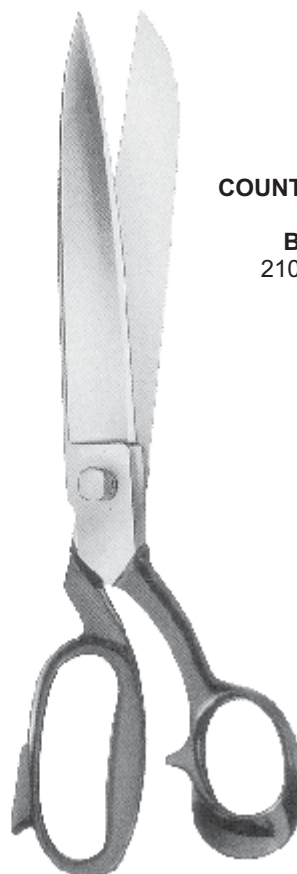

SCISSORS

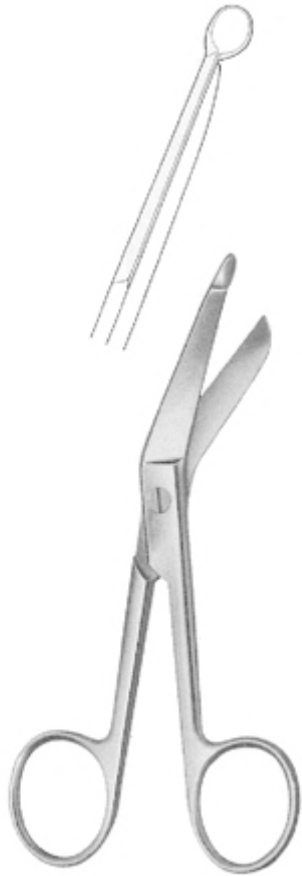

LISTER BANDAGE

B14-01201
 115mm (4.1/2")

B14-01202
 140mm (5.1/2")

B14-01203
 180mm (7")

B14-01204
 200mm (8")

B14-01205
 235mm (9.1/4")



SCHUMACHER UMBILICAL

B14-01206
 155mm (6")

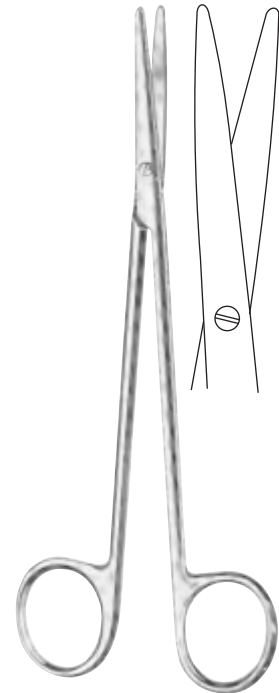

MCINDOE SCISSORS

B14-01207
 180mm (7")
 Straight

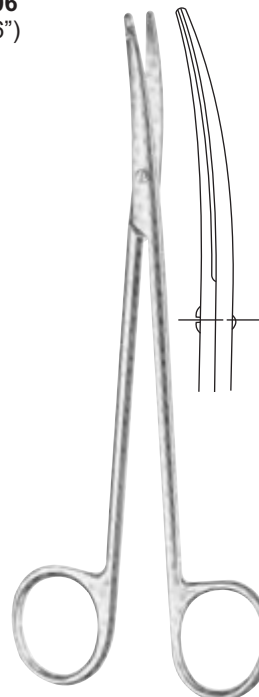

MCINDOE SCISSORS

B14-01208
 180mm (7")
 Curved



“TC” SCISSORS



IRIS SCISSORS
110mm (4.3/8")

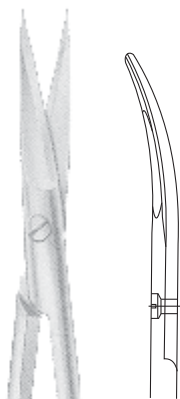

C1-01300



C1-01301

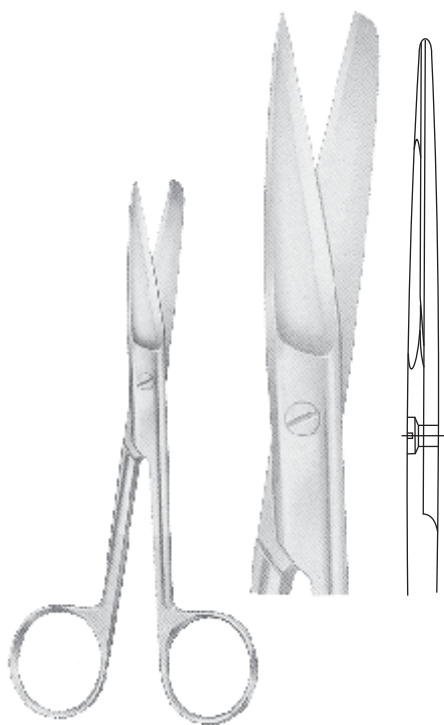

SURGICAL SCISSORS

- C1-01302**
- 130mm (5")
- 150mm (6")
- 180mm (7")

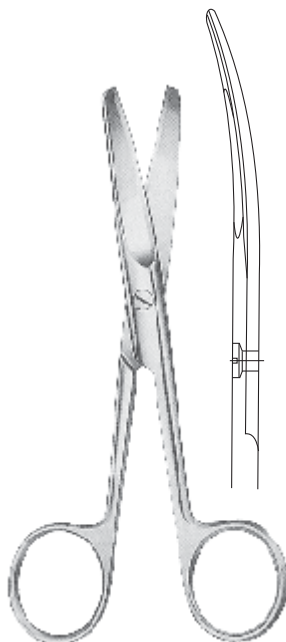

SURGICAL SCISSORS

- C1-01303**
- 130mm (5")
- 150mm (6")
- 180mm (7")



SURGICAL SCISSORS

- C1-01304**
- 130mm (5")
- 150mm (6")
- 180mm (7")



“TC” SCISSORS

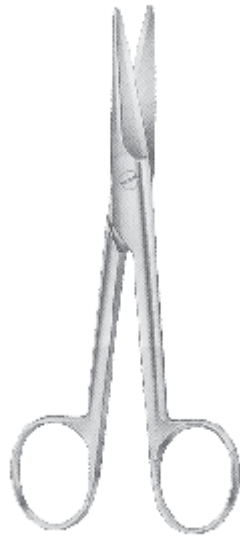

**MAYO
 DISSECTING
 SCISSORS**

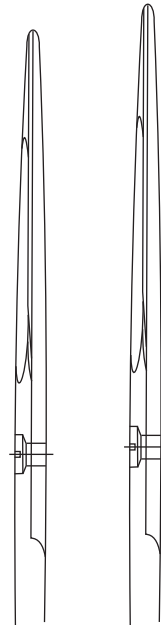

C2-01305
 140mm (5.1/2")
 150mm (6")
 180mm (7")
 200mm (8")
 230mm (9")



C2-01306
 140mm (5.1/2")
 150mm (6")
 180mm (7")
 200mm (8")
 230mm (9")

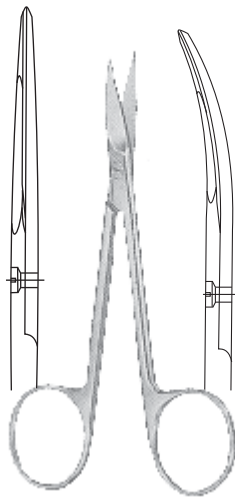

DELICATE SCISSORS
 120mm (4.3/4")

C2-01307 Straight

C2-01308 Curved

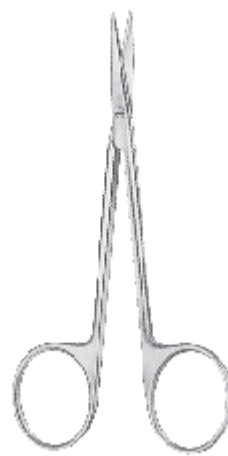

STRABISMUS SCISSORS
 115mm (4.1/2")

C2-01309 Straight

C2-01310 Curved

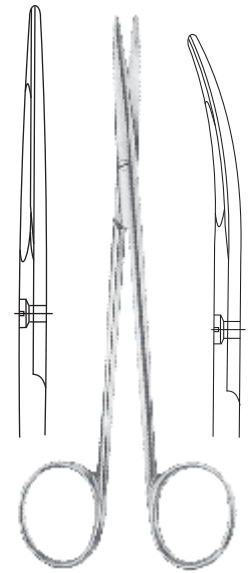

BABY METZANBAUM
 145mm (5,3/4")

C2-01311 Straight

C2-01312 Curved



“TC” SCISSORS



METZENBAUM
 Round Blade Straight



C3-01313
 180mm (7")



C3-01314
 145mm (5.3/4")



C3-01315
 180mm (7")



C3-01316
 200mm (8")



C3-01317
 145mm (5.3/4")

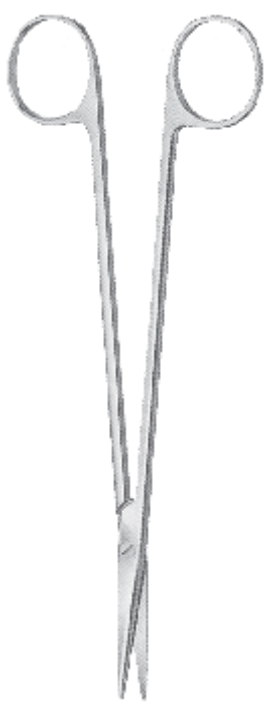

C3-01318
 180mm (7")



C3-01319
 200mm (8")



C3-01320
 230mm (9")

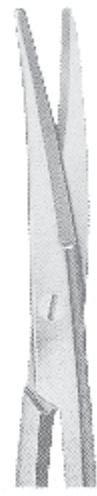

C3-01321
 180mm (7")



C3-01322
 200mm (8")



C3-01323
 230mm (9")



“TC” SCISSORS

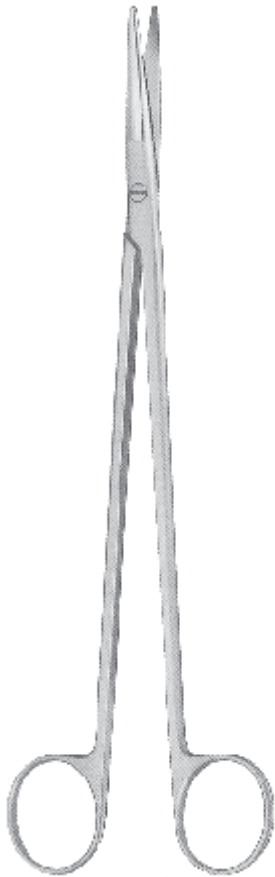

NELSON-METZENBAUM
 Straight

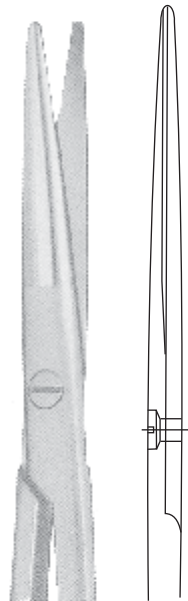

C4-01324
 230mm (9")
 300mm (12")

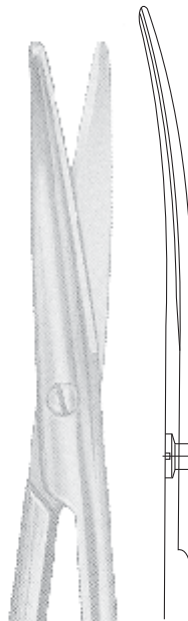

C4-01325
 230mm (9")
 Curved



C4-01326
 300mm (12")

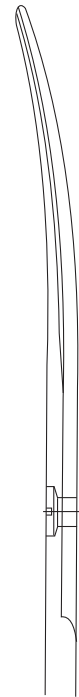

C4-01327
 230mm (9")
 Broad blade end

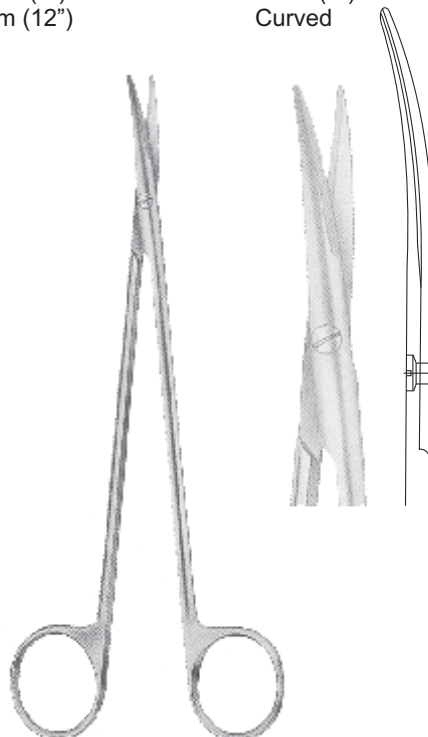

TOENNIS - ADSON
 Curved
C4-01328
 175mm (7")

“TC” SCISSORS

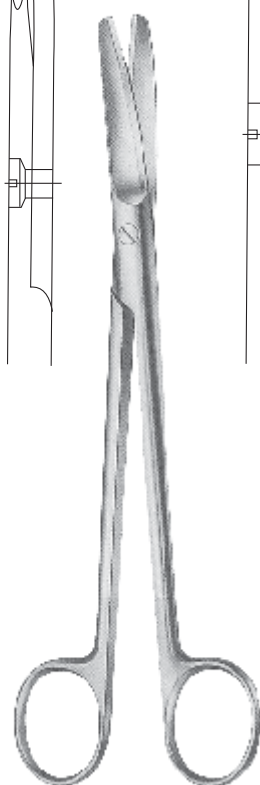
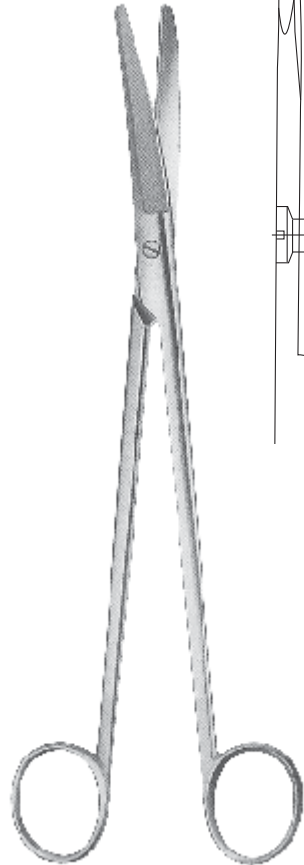
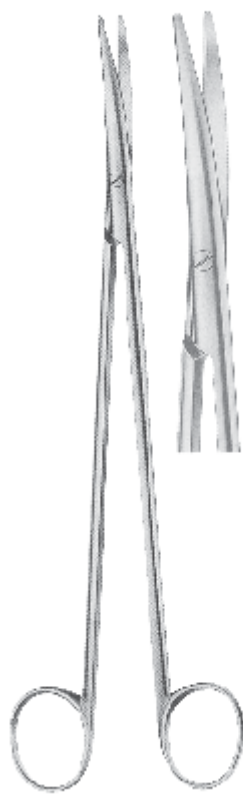
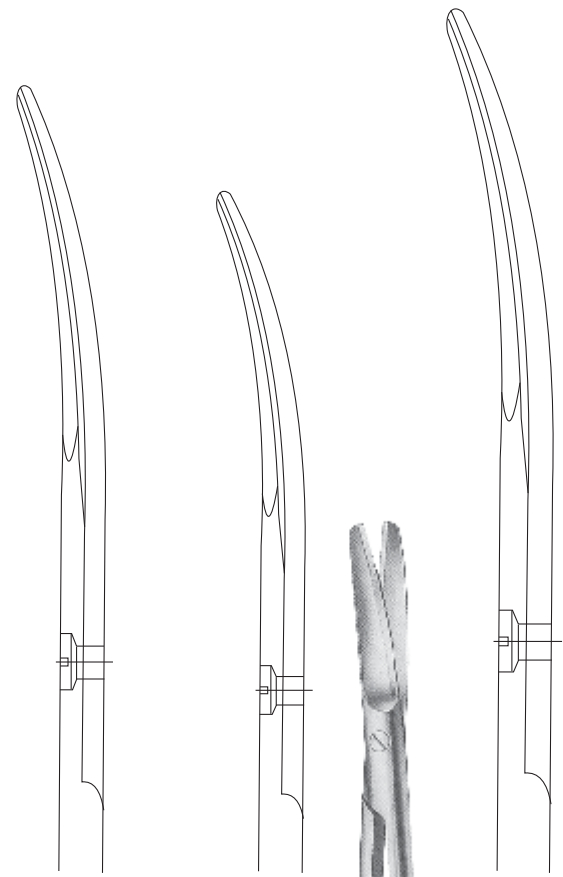
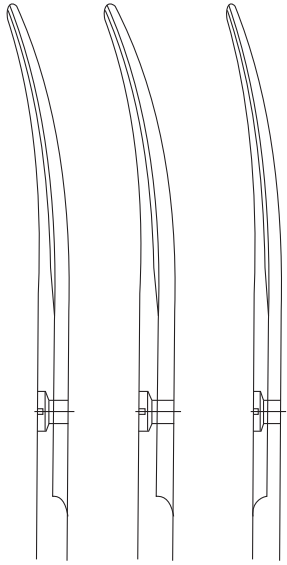

NELSON - METZENBAUM

C5-01329
 260mm (10.1/4")

C5-01330
 280mm (11")

C5-01331
 285mm (11.1/4")

NELSON - METZENBAUM
 Dissecting Scissors

C5-01332
 230mm (9")

SIMS

C5-01333
 200mm (8")

C5-01334
 230mm (9")

“TC” SCISSORS

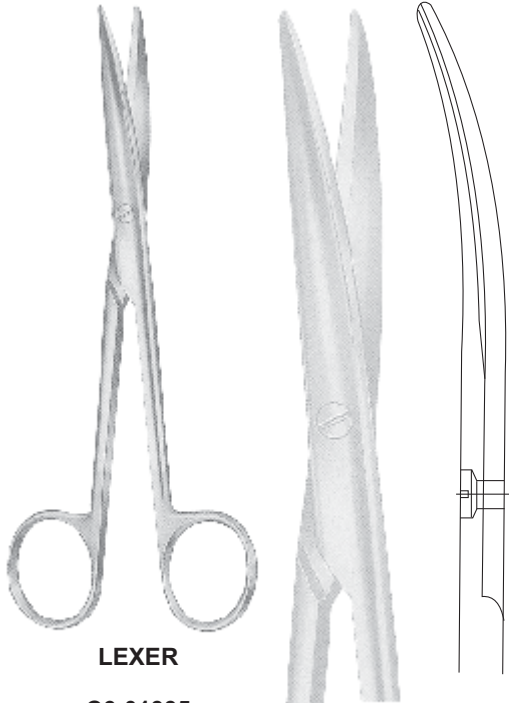

LEXER
C6-01335
 165mm (6.1/2")

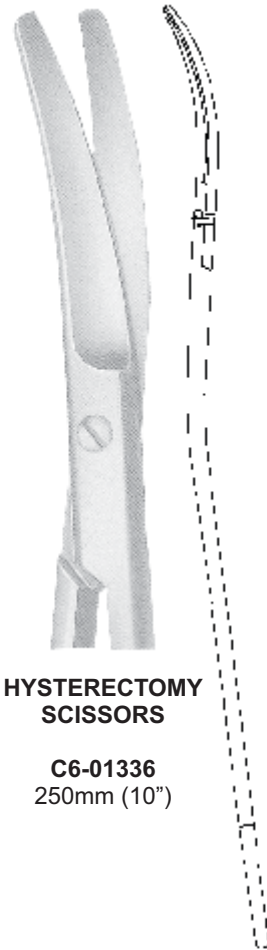

HYSTERECTOMY SCISSORS
C6-01336
 250mm (10")

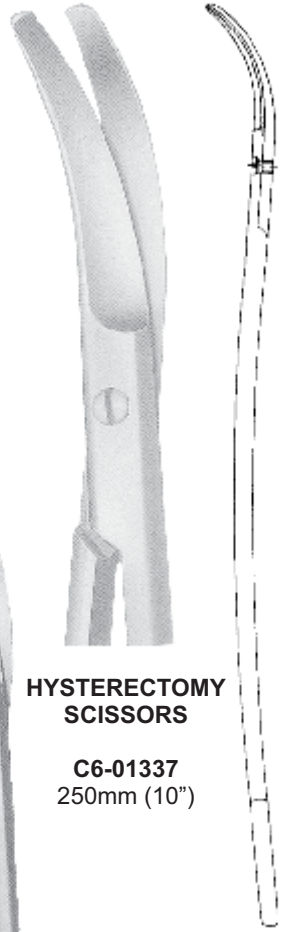

HYSTERECTOMY SCISSORS
C6-01337
 250mm (10")



MAYO-LEXER
C6-01338
 165mm (6.1/2")

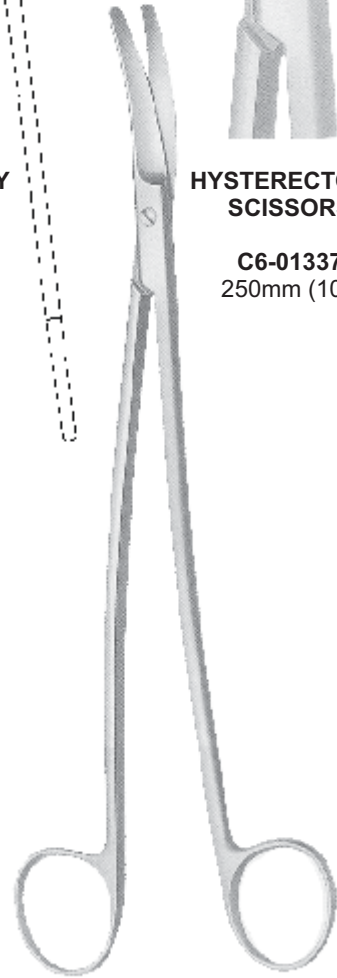

HYSTERECTOMY SCISSORS
 Strongly curved to fit with parametriumclamps



"TC" SCISSORS

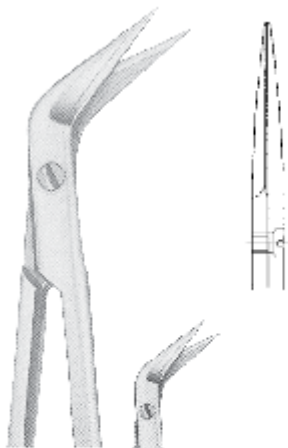

**DEBAKEY
VASCULAR SCISSORS**

C7-01341
220mm (8.3/4")

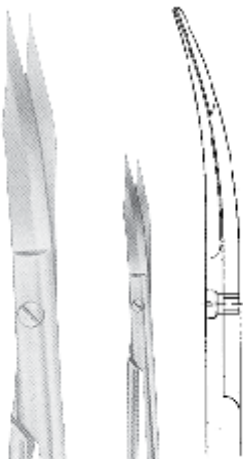

C7-01339
Sharp Point
130mm (5.1/8")
1 blad serrated

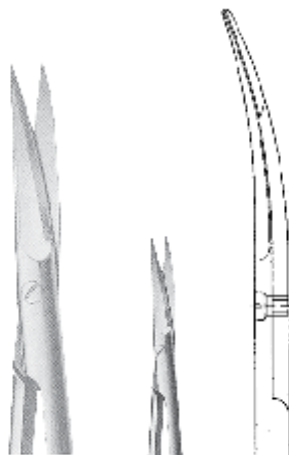

IRIS DELICATE

C7-01342
110mm (4.3/8")



C7-01340
120mm (4.3/4")
Wire cutting scissors
1 blade serrated

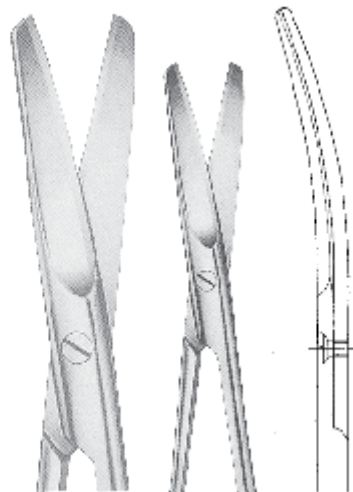

DRESSING SCISSORS

C7-01343
145mm (5.3/4")



“TC” SCISSORS

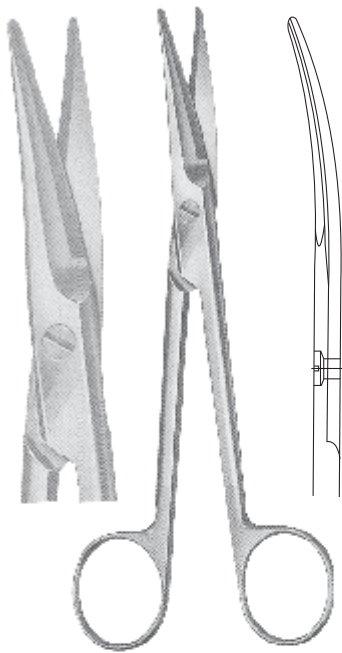

MAYO

C8-01344
 170mm (6.3/4")
 Dissecting Scissors

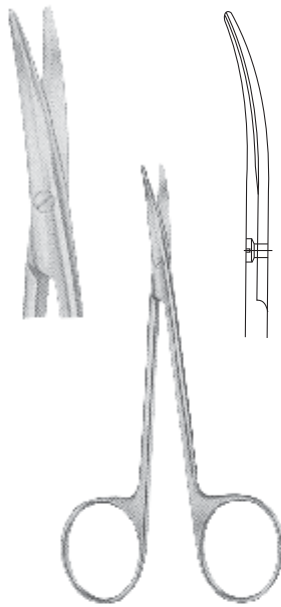

METZENBAUM DELICATE

C8-01345
 115mm (4.1/2")

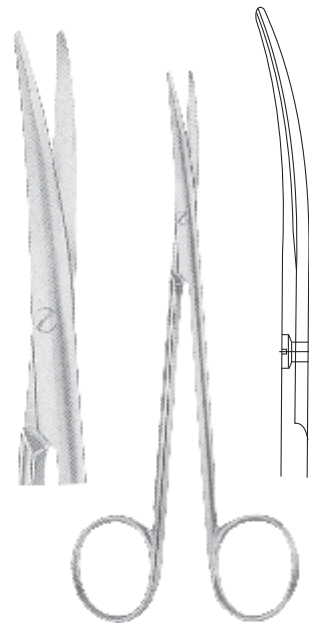

BABY METZENBAUM

C8-01346
 145mm (5.3/4")
 180mm (7")
 200mm (8")

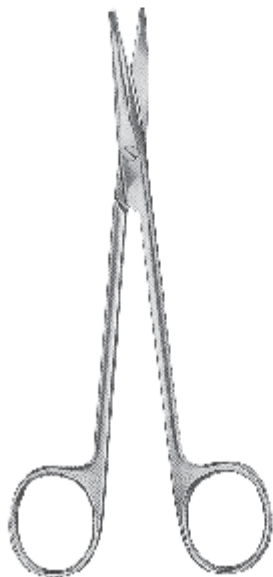

METZENBAUM



C8-01347
 145mm (5.3/4")



C8-01348
 180mm (7")



C8-01349
 200mm (8")



"TC" SCISSORS

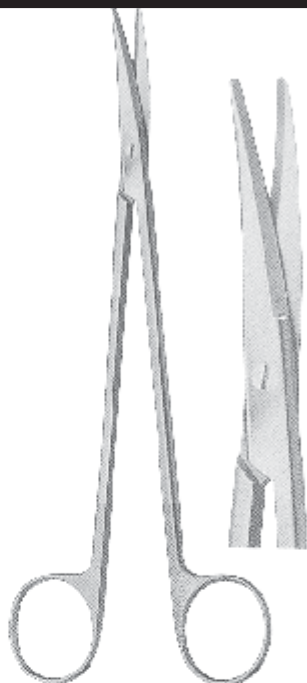
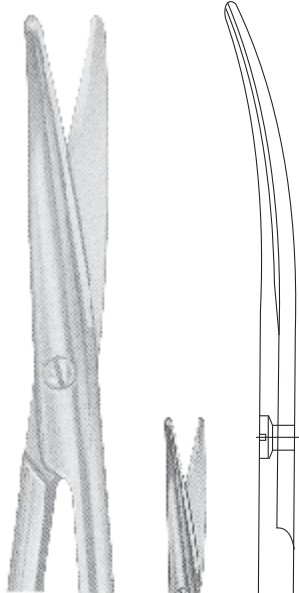

C9-01350
180mm
(7")



C9-01351
200mm
(8")



C9-01352
230mm
(9")

METZENBAUM

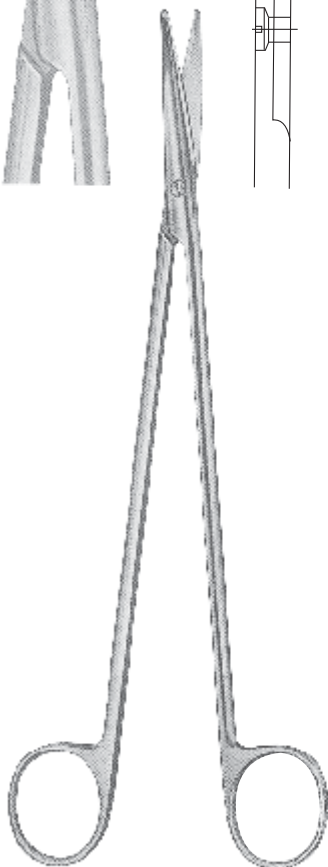

NELSON-METZENBAUM

C9-01353
230mm (9")



TOENNIS ADSON



C9-01354
175mm (7")



“TC” SCISSORS

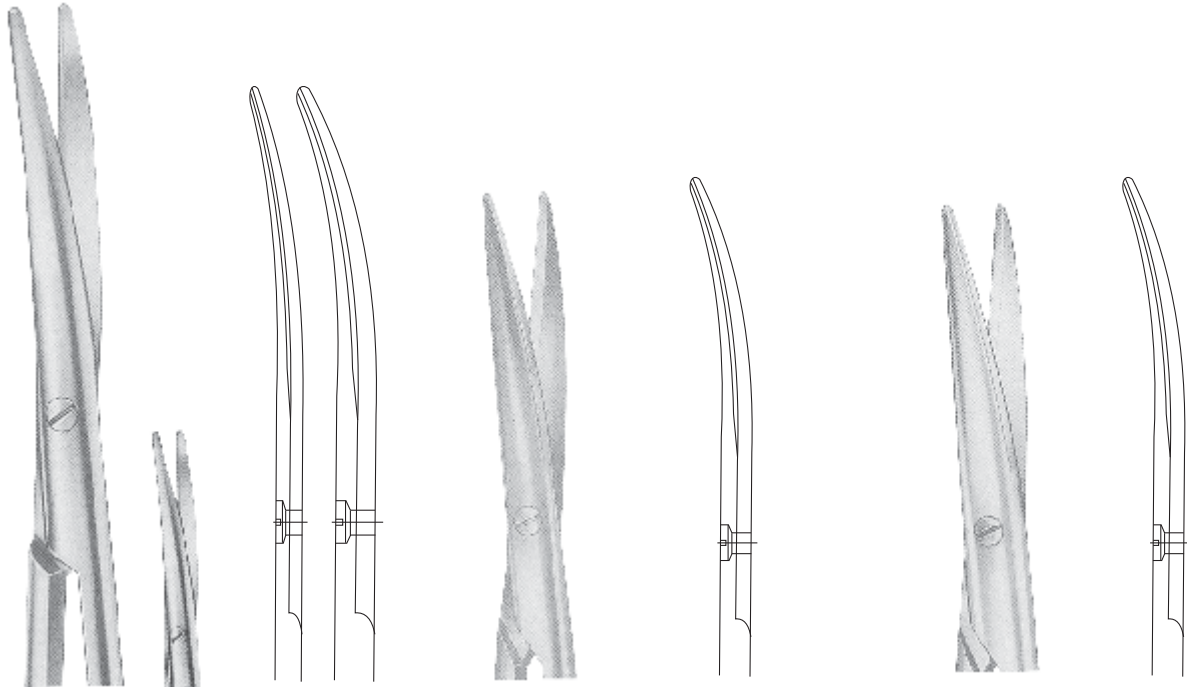

NELSON-METZENBAUM

C10-01355
 260mm (10.1/4")

C10-01356
 280mm (11")

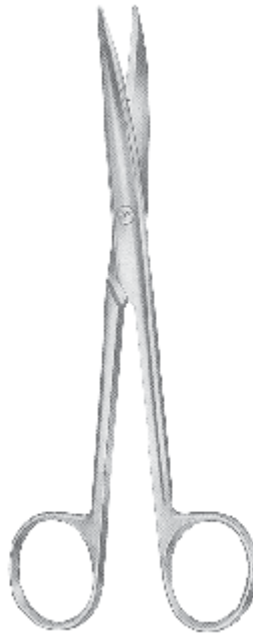

LEXER
 Straight
C10-01357
 165mm (6.1/2")



MAYO - LEXER
 Curved
C10-01358
 165mm (6.1/2")



"TC" SCISSORS

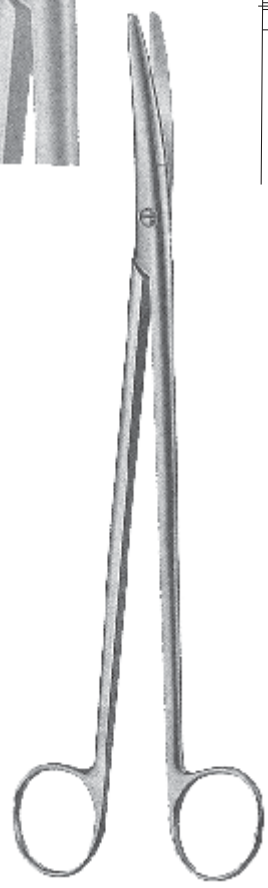
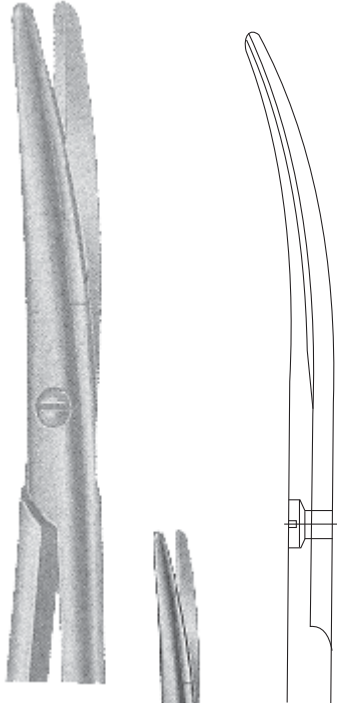

METZENBAUM

C11-01359
 230mm (9")
 With broad blade ends

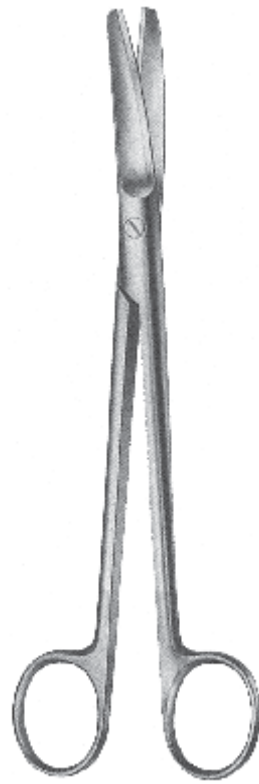

SIMS

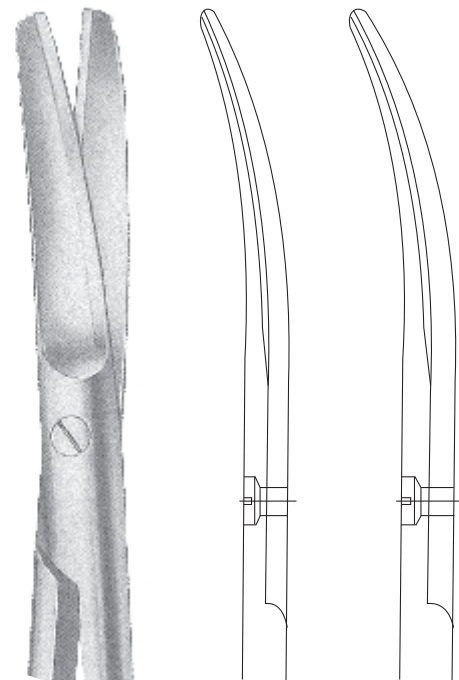

C11-01360 **C11-01361**
 200mm (8") 230mm (9")

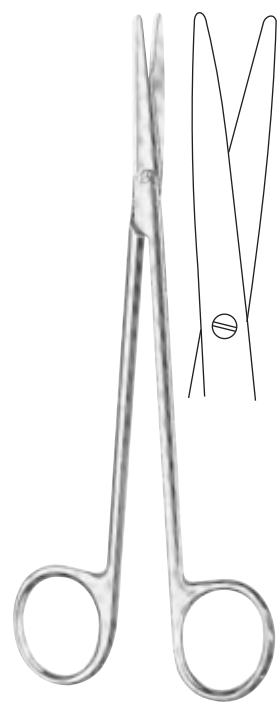

MCINDOE SCISSORS

C11-01362
 180mm (7")
 Straight

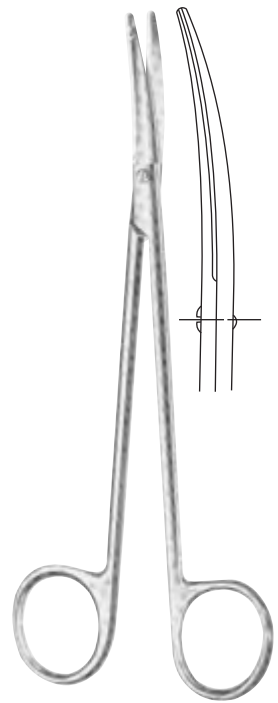

MCINDOE SCISSORS

C11-01363
 180mm (7")
 Curved



■■■■■
“TC” SCISSORS ■■■

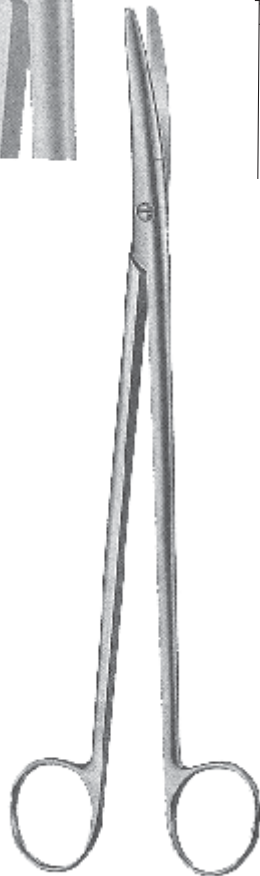
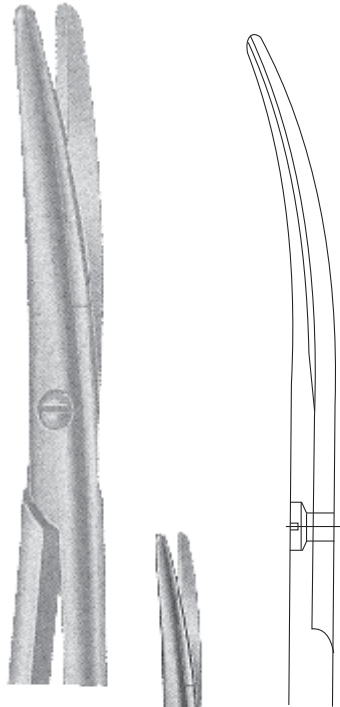

METZENBAUM
C11-01359
 230mm (9")
 With broad blade ends

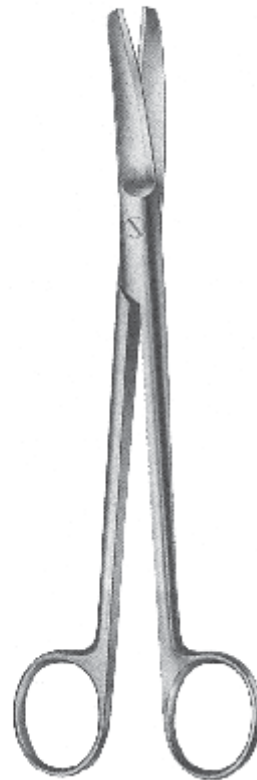
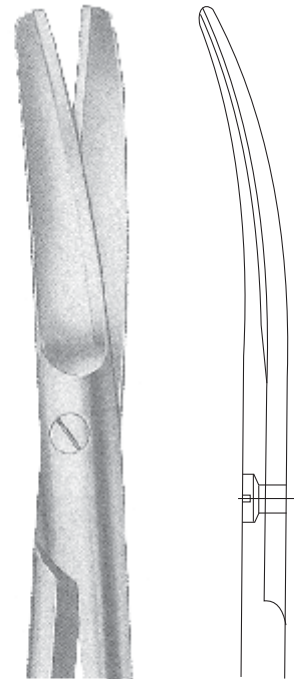

SIMS
C11-01360
 230mm (9")

SIMS
C11-01361
 200MM (8")

SUPER CUT SCISSORS



D1-01400
POTT-SMITH SCISSORS
Scissor for Vascular Surgery



D1-01401
KILNER SCISSORS
Scissor for Plastic Surgery

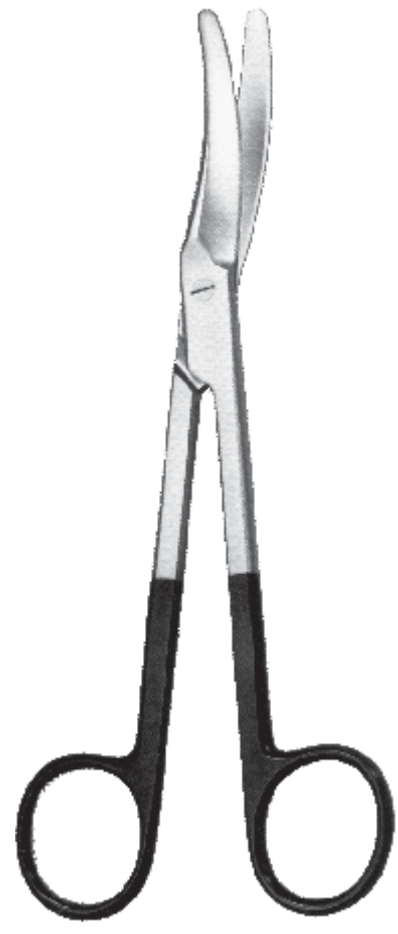

D1-01402

SUPER CUT SCISSORS



D2-01403
REYNOLDS SCISSORS
 150mm (6")
 180mm (7")

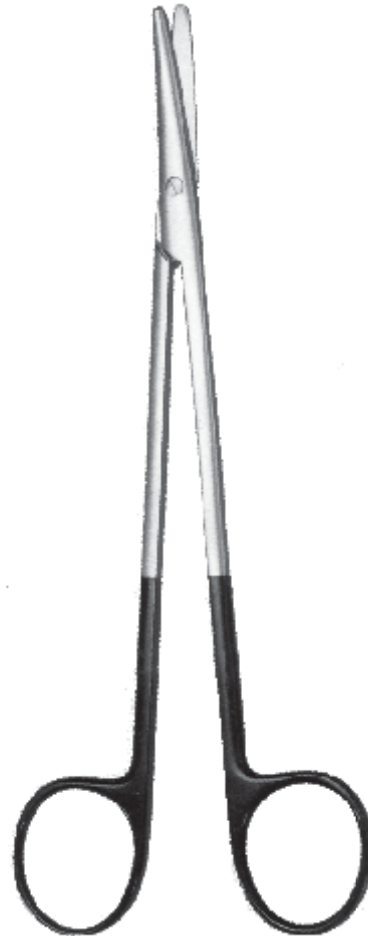

D2-01404
METZENBAUM
 Straight
 145mm (5.3/4")
 180mm (7")
 200mm (8")

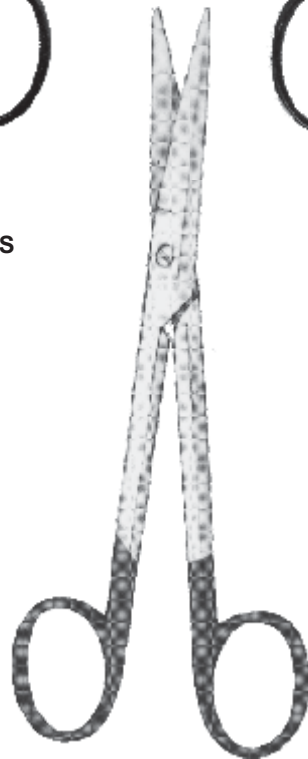

D2-01405
MAYO
 140mm (5.1/2")



D2-01406
McIndoe
 190mm (7.1/4")



SERRATED DISSECTING FORCEPS



CANADIAN
Straight

E1-02100
130mm (5.1/8")

E1-02101
150mm (6")



DISSECTING FORCEPS
Turn over end

E1-02102
125mm (5")

E1-02103
150mm (6")

E1-02104
180mm (7")

E1-02105
200mm (8")

E1-02106
250mm (10")



DISSECTING FORCEPS
Block end

E1-02107
125mm (5")

E1-02108
150mm (6")

E1-02109
180mm (7")

E1-02110
200mm (8")

E1-02111
250mm (10")



SERRATED DISSECTING FORCEPS



**DISSECTING
 FORCEPS**



E2-02112
 115mm
 (4.1/2")



E2-02113
 130mm
 (5.1/8")



E2-02114
 145mm
 (5.3/4")



E2-02115
 160mm
 (6.1/4")



E2-02116
 305mm
 (12")



**DISSECTING
 FORCEPS**



E2-02117
 150mm
 (6")



E2-02118
 180mm
 (7")



E2-02119
 200mm
 (8")

SERRATED DISSECTING FORCEPS



**DISSECTING
 FORCEPS**
 Round Points



E3-02120
 115mm
 (4.1/2")



E3-02121
 130mm
 (5.1/8")



E3-02122
 150mm
 (6")



E3-02123
 160mm
 (6.1/4")



E3-02124
 180mm
 (7")



E3-02125
 200mm
 (8")



E3-02126
 250mm
 (10")



E3-02127
 300mm
 (12")

SERRATED DISSECTING FORCEPS



RAMSEY
E4-02128
 180mm (7")



BONNEY
E4-02129
 180mm (7")



BICKFORD
E4-02130
 225mm (9")

SERRATED DISSECTING FORCEPS



MAINGOT INTESTINAL
Fenestrated Grip

E5-02131
280mm (11")



ST MARKS

E5-02132
290mm (11.1/2")



EMMET

E5-02133
200mm (8")

DELICATE DISECTING FORCEPS

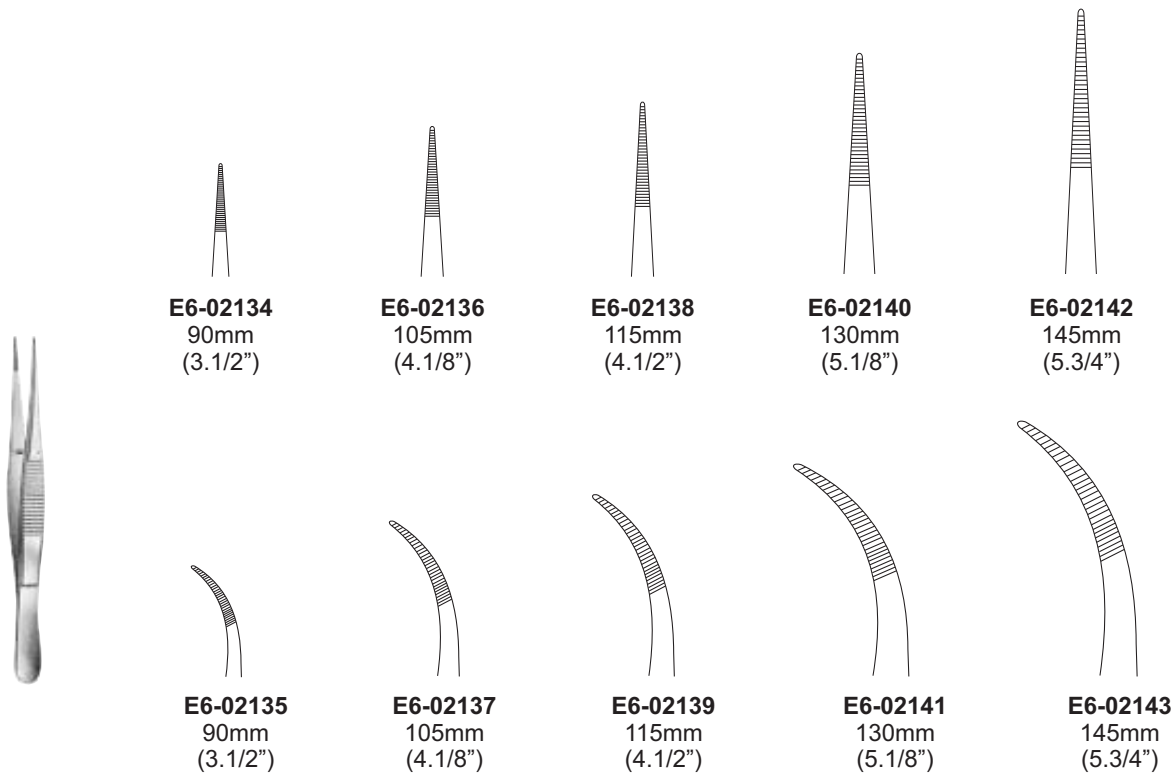

E6-02134
 90mm
 (3.1/2")

E6-02136
 105mm
 (4.1/8")

E6-02138
 115mm
 (4.1/2")

E6-02140
 130mm
 (5.1/8")

E6-02142
 145mm
 (5.3/4")

E6-02135
 90mm
 (3.1/2")

E6-02137
 105mm
 (4.1/8")

E6-02139
 115mm
 (4.1/2")

E6-02141
 130mm
 (5.1/8")

E6-02143
 145mm
 (5.3/4")

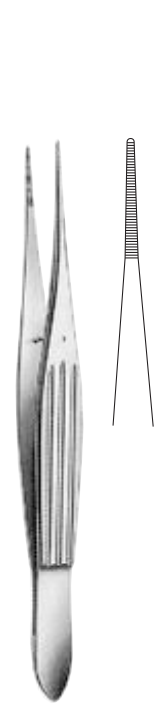

MACINDOE
E6-02144
 150mm (6")

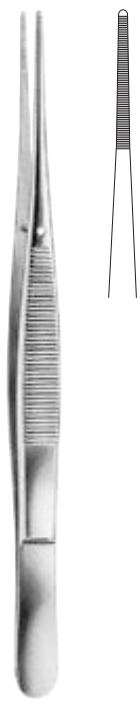

WAUGH
E6-02145
 200mm (8")



WAUGH

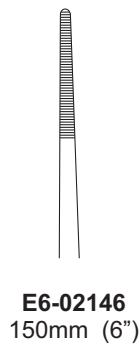

E6-02146
 150mm (6")

E6-02147
 180mm (7")

DELICATE DISECTING FORCEPS



ADSON

E7-02148
 125mm (5") Fine

E7-02149
 125mm (5") Standard

E7-02150
 190mm (7.1/2")



CAIRNS (DOTT)

E7-02151
 215mm (8.1/2")
 Medium jaw
 2mm wide

E7-02152
 180mm (7")
 Fine jaw
 1mm wide



JEFFERSON

E7-02153
 180mm (7")



SILCOCK

E7-02154
 100mm (4")



EXTRA FINE
 100mm (4")



E7-02155



E7-02156

TOOTHED DISSECTING FORCEPS



TREVES
 1 x 2 teeth

E8-02157
 125mm (5")

E8-02158
 150mm (6")

E8-02159
 180mm (7")

E8-02160
 200mm (8")

E8-02161
 250mm (10")

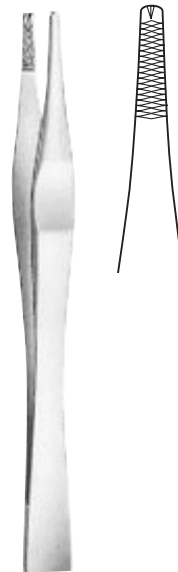

LANE
 1 x 2 teeth

E8-02162
 125 mm (5")

E8-02163
 145mm (5.3/4")

E8-02164
 180mm (7")

LANE
 2 x 3 teeth

E8-02165
 145mm (5.3/4")

E8-02166
 180mm (7")



DISSECTING FORCEPS

E8-02167
 150mm (6")
 2 x 3 teeth

E8-02168
 150mm (6")
 3 x 4 teeth

TOOTHED DISSECTING FORCEPS

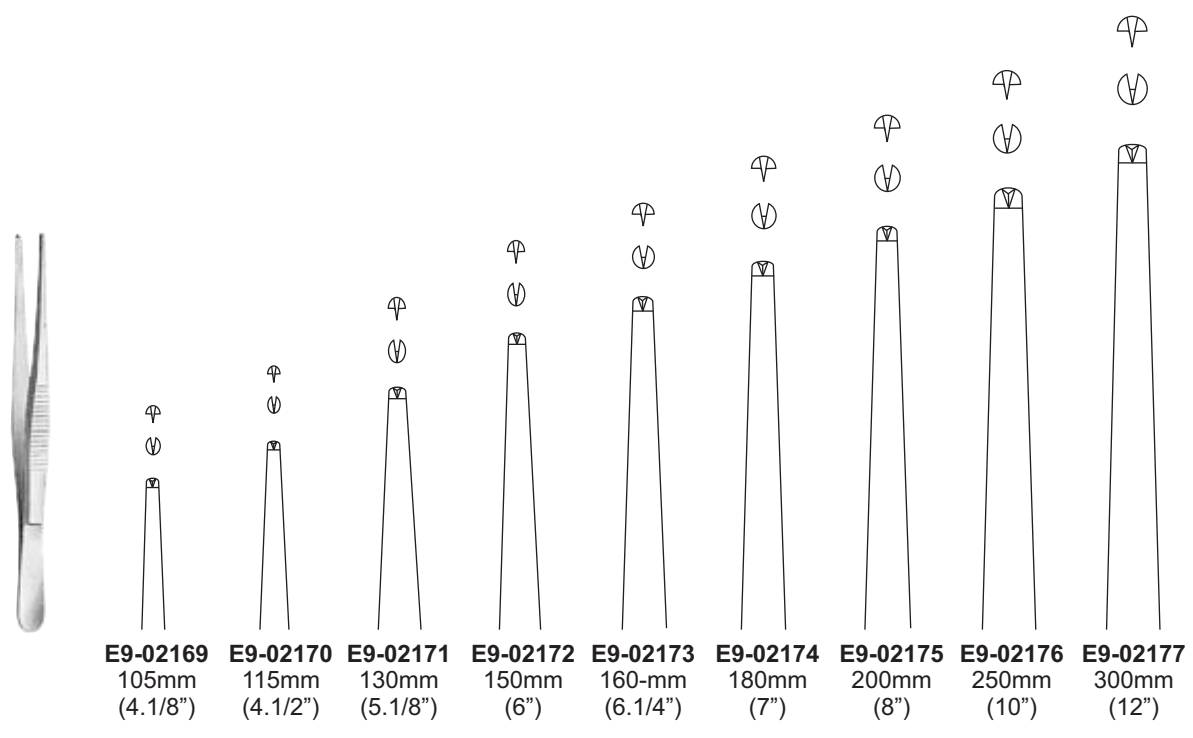

E9-02169 105mm (4.1/8")	E9-02170 115mm (4.1/2")	E9-02171 130mm (5.1/8")	E9-02172 150mm (6")	E9-02173 160mm (6.1/4")	E9-02174 180mm (7")	E9-02175 200mm (8")	E9-02176 250mm (10")	E9-02177 300mm (12")
--------------------------------------	--------------------------------------	--------------------------------------	----------------------------------	--------------------------------------	----------------------------------	----------------------------------	-----------------------------------	-----------------------------------

DISSECTING FORCEPS 1 x 2 teeth

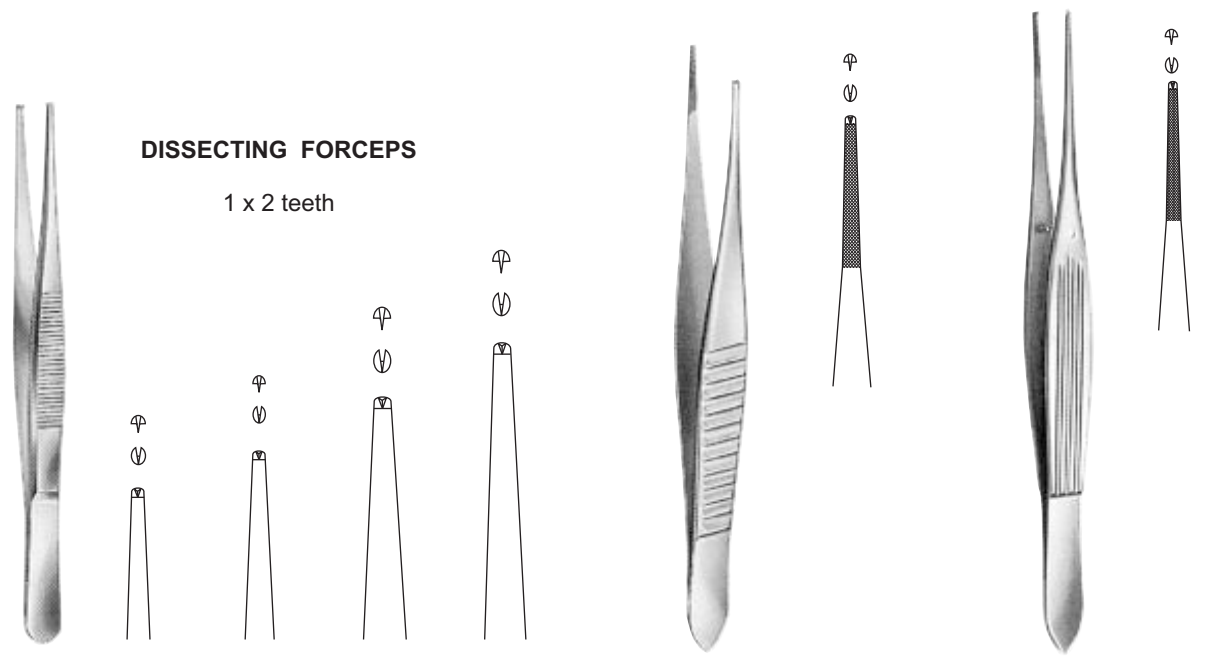

E9-02178 115mm (4.1/2")	E9-02179 130mm (5.1/8")	E9-02180 145mm (5.3/4")	E9-02181 160mm (6.1/4")
--------------------------------------	--------------------------------------	--------------------------------------	--------------------------------------

GILLIES
E9-02182
 150mm (6")
 1 x 2 teeth

MICINDOE
E9-02183
 150mm (6")
 1 x 2 teeth

TOOTHED DISSECTING FORCEPS



WAUGH
 1 x 2 teeth
E10-02184
 200mm (8")
E10-02185
 180mm (7")
E10-02186
 150mm (6")

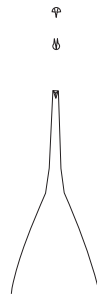

ADSON
 1 X 2 teeth
E10-02187
 125mm (5") Fine
E10-02188
 125mm (5") Standard
E10-02189
 190mm (7.1/2")



ADSON
 Bayonet
 1 x 2 teeth
E10-02190
 190mm (7.1/2")



JEFFERSON
 1 x 2 teeth
E10-02191
 180mm (7")



ADSON-BROWN
 7 x 7 teeth
E10-02192
 125mm (5")



PENNYBACKER
 3 x 4 teeth
E10-02193
 160mm (6.1/2")

TOOTHED DISSECTING FORCEPS

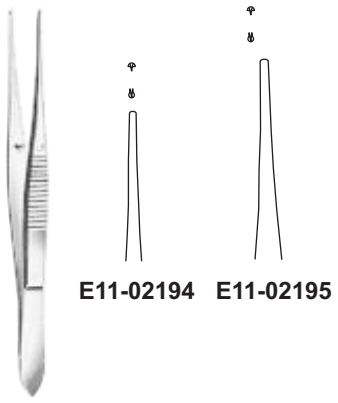

E11-02194 E11-02195

SILCOCK
 1 x 2 teeth
E11-02194
 100mm (4")
E11-02195
 110mm (4.3/8")

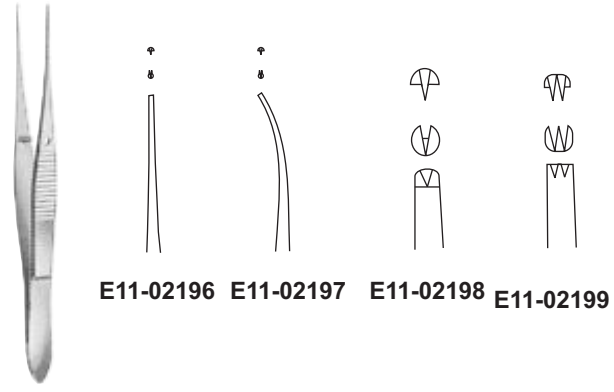

E11-02196 E11-02197 E11-02198 E11-02199

FINE
 1 x 2 teeth
E11-02196
 100mm (4")
E11-02197
 100mm (4")



RAMSEY
 180mm (7")

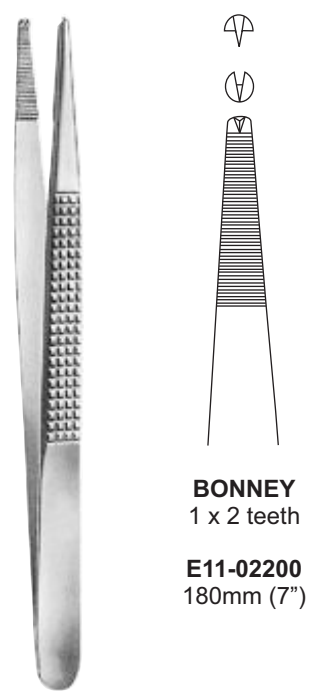

BONNEY
 1 x 2 teeth
E11-02200
 180mm (7")



BICKFORD
 1 x 2 teeth
E11-02201
 225mm (9")



CANADIAN
 2 x 3 teeth
E11-02202
 140mm (5.1/2")
E11-02203
 150mm (6")

TOOTHED DISSECTING FORCEPS

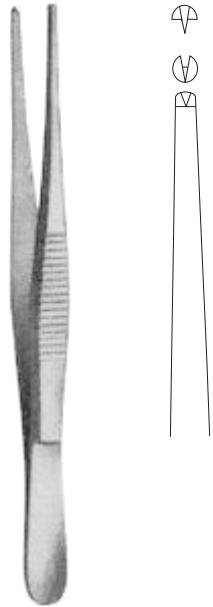

ST MARKS
 1 X 2 teeth
E12-02204
 290mm (11.1/2")



OFFICER
 4 x 5 teeth
E12-02205
 150mm (6")



**JACKSON
 BURROWS**
 1 x 2 teeth
E12-02206
 140mm (5.1/2")



RUSSIAN
 With circular jaw
E12-02208
 150mm (6")
E12-02209
 200mm (8")
E12-02210
 250mm (10")



MUSTARDE
 Combined, double hooked jaw
E12-02207
 150mm (6")



**NELSON LUNG
 ADHESION**
E12-02211
 230mm (9")

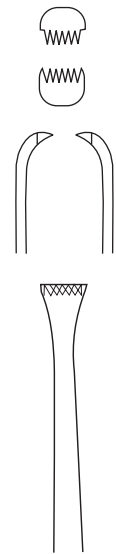

SPLINTER FORCEPS



E13-02212

ARTHURE
 140mm (5.1/2")



E13-02213

FEILCHENFEL
 70mm (3")
 90mm (3.1/2")
 115mm (4.1/2")

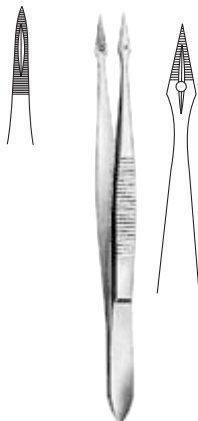

E13-02214

HUNTER
 105mm (4.1/8")



DENIS BROWNE

E13-02215
 190mm (7.1/2")



MICRO SOFT TOUCH RING TIP

E13-02216
 150mm (6")
E13-02217
 185mm (7.1/4")
E13-02218
 210mm (8.1/4")
E13-02219
 230mm (9")
E13-02220
 250mm (10")

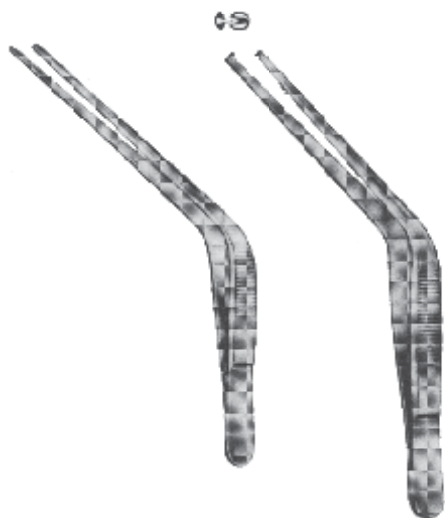

TROELTSCH (Wilde)

E13-02221
 110mm (4.1/2")

TROELTSCH (Wilde)

E13-02222
 120mm (4.3/4")
 1 x 2 teeth



TUDICHUM

E13-02223
 65mm (2.3/2")

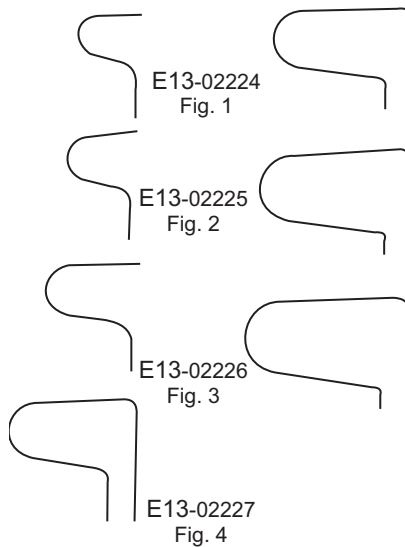

E13-02224
 Fig. 1

E13-02225
 Fig. 2

E13-02226
 Fig. 3

E13-02227
 Fig. 4

■ ■ ■ ■ ■
“TC” DISSECTING FORCEPS ■ ■ ■ ■ ■

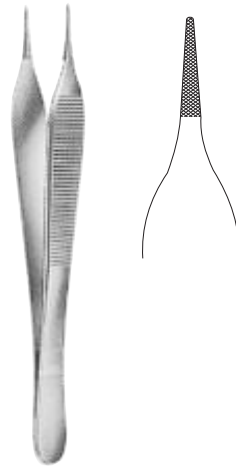

ADSON

F1-03100
 120mm (4.3/4")

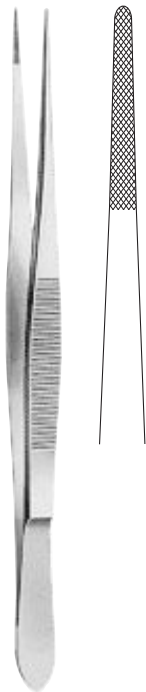

CUSHING

F1-03101
 180mm (7")
 With scraper end



F1-03102
 145mm
 (5.3/4")

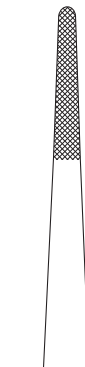

F1-03103
 200mm
 (8")



F1-03104
 250mm
 (10")



“TC” DISSECTING FORCEPS



F2-03105
 145mm
 (5.3/4")



F2-03106
 180mm
 (7")



F2-03107
 200mm
 (8")



F2-03108
 250mm
 (10")



WANGENSTEEN



F2-03109
 150mm
 (6")



F2-03110
 230mm
 (9")

■ ■ ■ ■ ■
“TC” DISSECTING FORCEPS ■ ■ ■ ■ ■

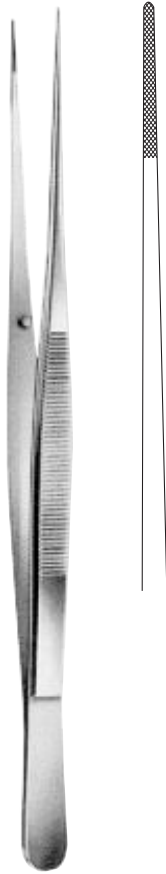

F3-03111
 230mm (9")



F3-03112
 185mm (7.1/4")



F3-03113
 150mm (6")



F3-03114
 190mm (7.1/2")



F3-03115
 160mm (6.1/4")

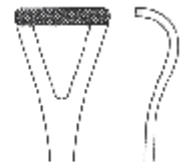

F3-03116
 200mm (8")



ALLIS



BABCOCK





DISSECTING & LIGATURE FORCEPS



LIGATURE FORCEPS
F4-04100
 95mm (3.3/4")
 Straight, smooth jaw



MICRO ADSON
F4-04101
 140mm (5.1/2")



F4-04102
 185mm (7.1/4")



F4-04103
 210mm (8.1/4")



BABY - ADSON



F4-04104
 140mm
 (5.1/2")



F4-04105
 180mm
 (7")



S.SHAPED DELICATE



"TC" DISSECTING FORCEPS

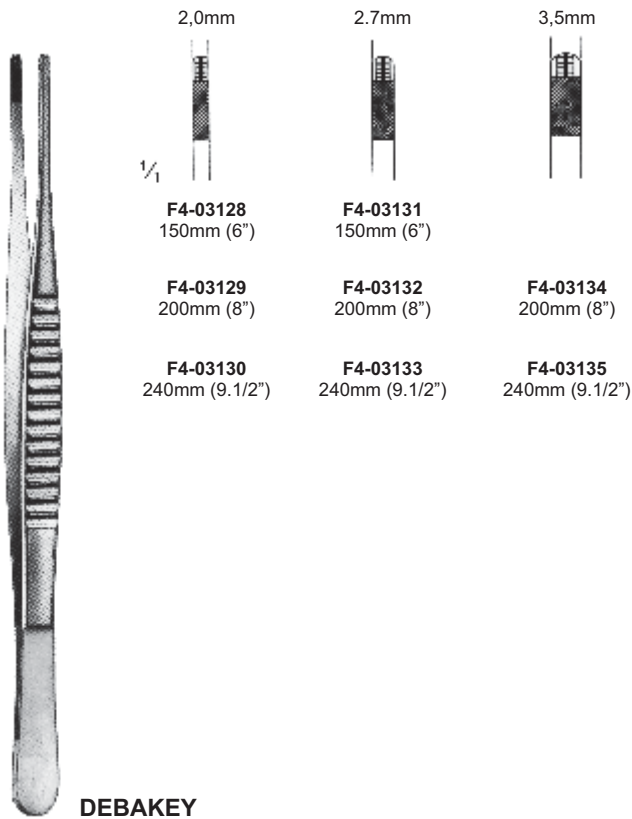
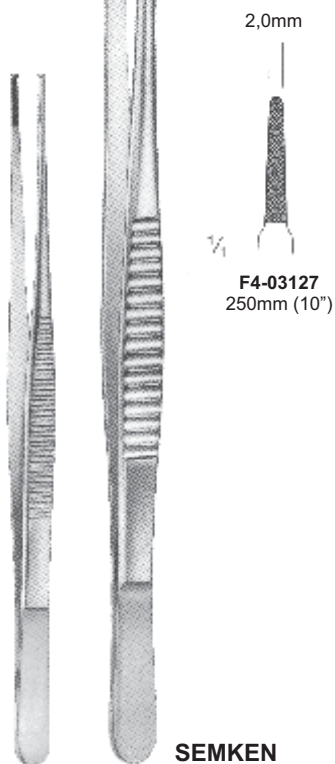
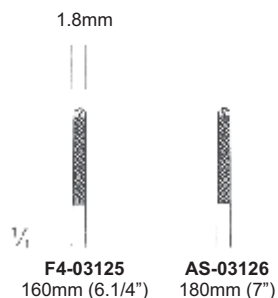
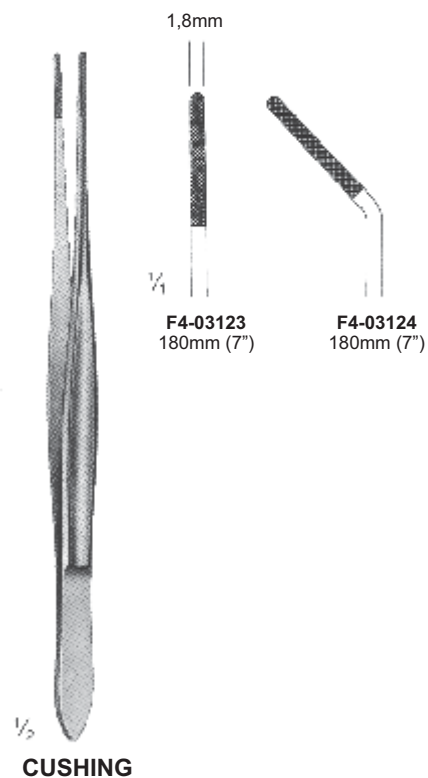
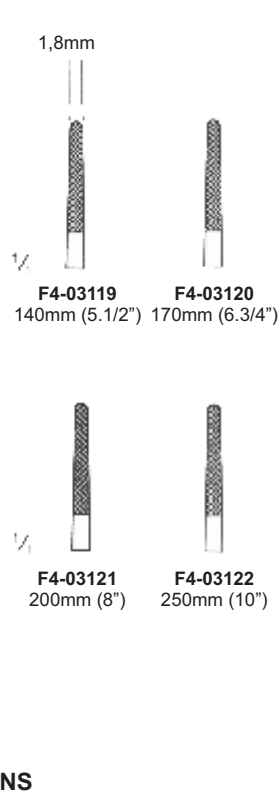
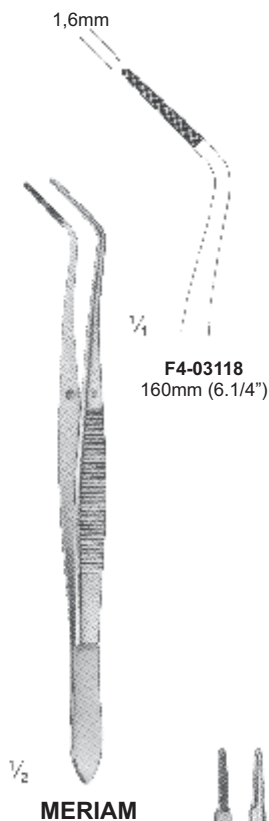
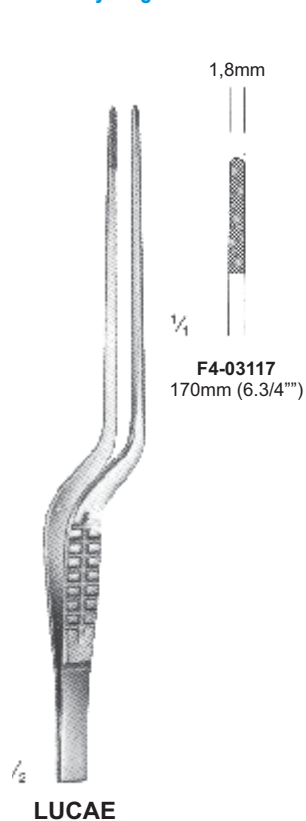

DISSECTING & LIGATURE FORCEPS



F5-04106
 215mm (8.1/2")



F5-04107
 210mm (8.1/4")



F5-04108
 220mm (8.3/4")



F5-04109
 225mm (9")



F5-04110
 225mm (9")



**FINE CURVED DISSECTING
 FORCEPS**



F5-04111
 295mm (11.3/4")



F5-04112
 295mm (11.3/4")

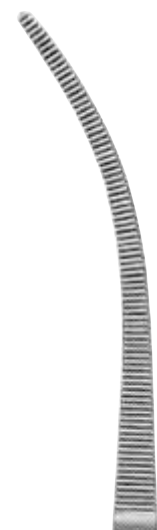

F5-04113
 300mm (12")

"TC" DISSECTING FORCEPS

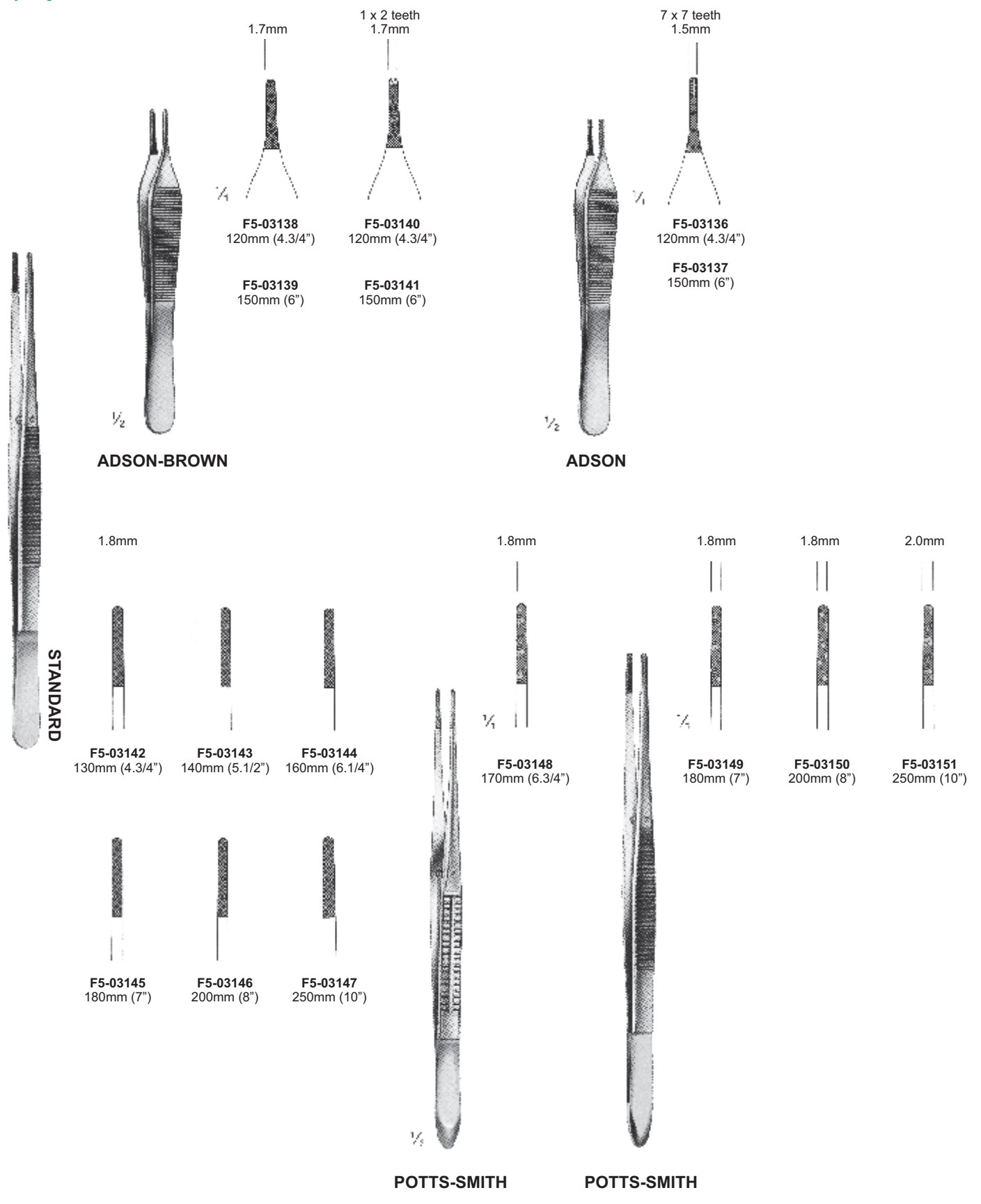

F5-03138
120mm (4.3/4")

F5-03140
120mm (4.3/4")

F5-03136
120mm (4.3/4")

F5-03139
150mm (6")

F5-03141
150mm (6")

F5-03137
150mm (6")

ADSON-BROWN

ADSON

F5-03142
130mm (4.3/4")

F5-03143
140mm (5.1/2")

F5-03144
160mm (6.1/4")

F5-03148
170mm (6.3/4")

F5-03149
180mm (7")

F5-03150
200mm (8")

F5-03151
250mm (10")

F5-03145
180mm (7")

F5-03146
200mm (8")

F5-03147
250mm (10")

POTTS-SMITH

POTTS-SMITH

TISSUE FORCEPS



RUTHERFORD MORISON

F6-04201
 150mm (6")
 6 x 7 teeth



STILES (ALLIS-THOMS)

F6-04202
 200mm (8")
 6 x 7 teeth



LANE

1 x 2 teeth fenestrated

F6-04203
 125mm (5")

F6-04204
 150mm (6")

F6-04205
 195mm (7.3/4")

TISSUE FORCEPS



BABCOCK
F7-04206
 165mm (6.1/2")



BABCOCK
F7-04207
 200mm (8")
 Extra light



BABCOCK
F7-04208
 230mm (9")



TISSUE FORCEPS

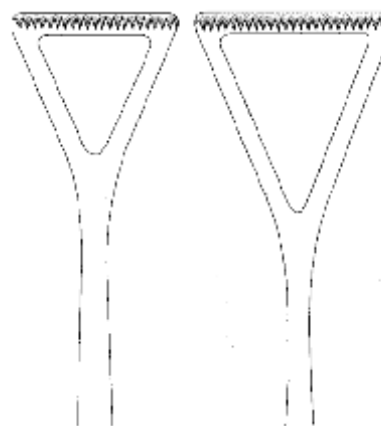

DUVAL

F8-04209
140mm (5.1/2")



DUVAL

F8-04210
180mm (7")



DUVAL

F8-04211
190mm (7.1/2")

F8-04212
200mm (8")



MOUTH GAGS

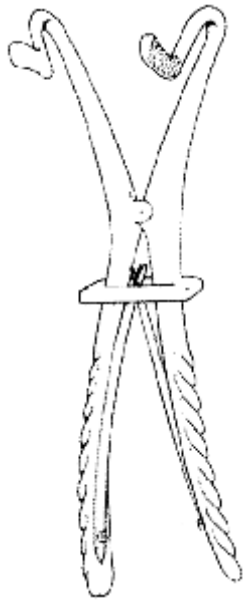

FERGUSSON ACLAND

F9-04300
 170mm (6.3/4")

F9-04301
 200mm (8")



DOYEN (CHILD)

F9-04302
 120mm (4.3/4")



FEATHERSTONE

F9-04303
 165mm (6.1/2")



DOYEN (ADULT)

F9-04304
 140mm (5.1/2")

TONGUE DEPRESSORS

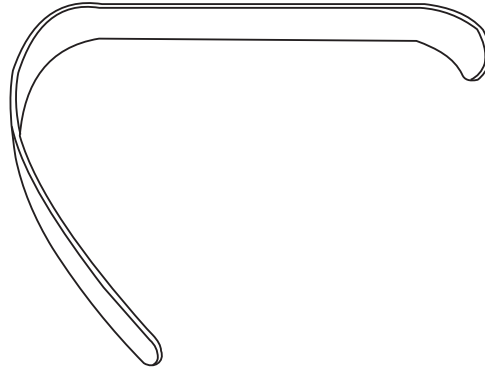

LACK TONGUE DEPRESSOR

F10-04305
 13mm wide
 child

F10-04306
 19mm wide
 Adolescent

F10-04307
 22mm wide
 Adults



F10-04308
 180mm (7")

FLAT TONGUE DEPRESSOR

Double ended
 tapering 19mm + 23mm



F10-04309
 140mm (5.1/2")

TONGUE DEPRESSORS



F11-04310



F11-04311



COLLIN TONGUE FORCEPS

F11-04310
 170mm (6.3/4")

F11-04311
 160mm (6.1/4")



HEYWOOD-SMITH TONGUE FORCEPS

F11-04312
 200mm (8")

PREPARATION INSTRUMENTS



F12-04313



F12-04314



**MAGILL CATHETER
INTRODUCING FORCEPS**

CHILD
F12-04313
200mm (8")

ADULT
F12-04314
250mm (10")

TOWEL CLAMPS



ROBIN

F13-04400
 140mm (5.1/2")
 holder diameter 5mm

F13-04401
 140mm (5.1/2")
 holder diameter 13mm

F13-04402
 140mm (5.1/2")
 holder diameter 25mm

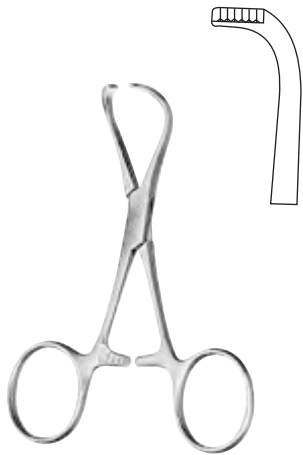

EDNA (LORNA)

F13-04403
 100mm (4")



EDNA (LORNA)

F13-04404
 130mm (5.1/4")



DOYEN

F13-04405
 190mm (7.1/2")



TOWEL CLAMPS



BALL AND SOCKET

F14-04406
130mm (5")



BACKHAUS

F14-04407
90mm (3.1/2")



F14-04408
100mm (4.3/4")



F14-04409
135mm (5.1/4")

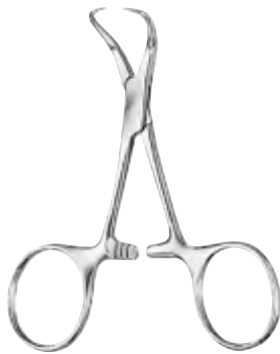

MAYO

F14-04410
140mm (5.1/2")



MOYNIHAN

F14-04411
190mm (7.1/2")
2 x 2 teeth





SCHAEDEL

F15-04412
90mm (3.1/8")
Cross action

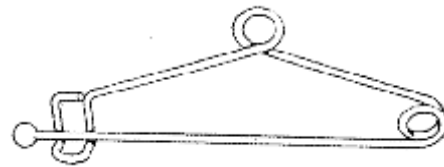

MAYO SAFETY PIN FORCEPS HOLDER

F15-04413
115mm (4.1/2")

SPONGE HOLDING FORCEPS



RAMPLEY
F16-04500
 180mm (7")
F16-04501
 240mm (9.1/2")



FORESTER
F16-04502
 240mm (9.1/2")
F16-04503
 180mm (7")
 Straight
F16-04504
 240mm (9.1/2")
F16-04505
 180mm (7")
 Curved on flat

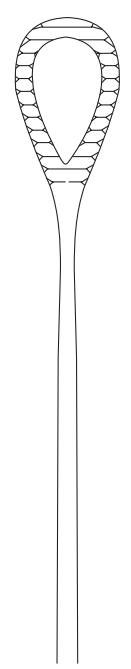

F16-04502

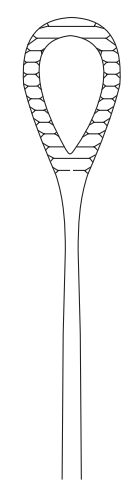

F16-04503



F16-04504

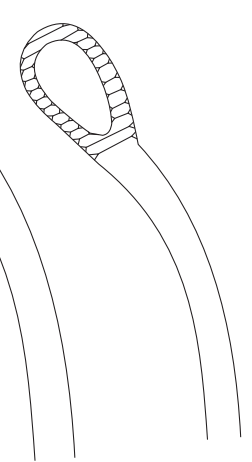

F16-04505

DRESSING FORCEPS

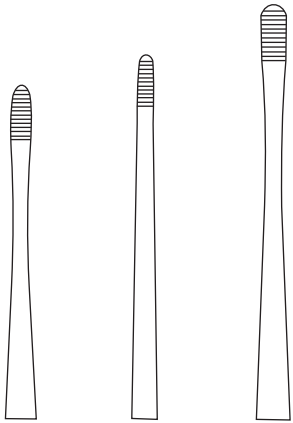

F17-04506 125mm (5")
F17-04507 150mm (6")
F17-04508 180mm (7")

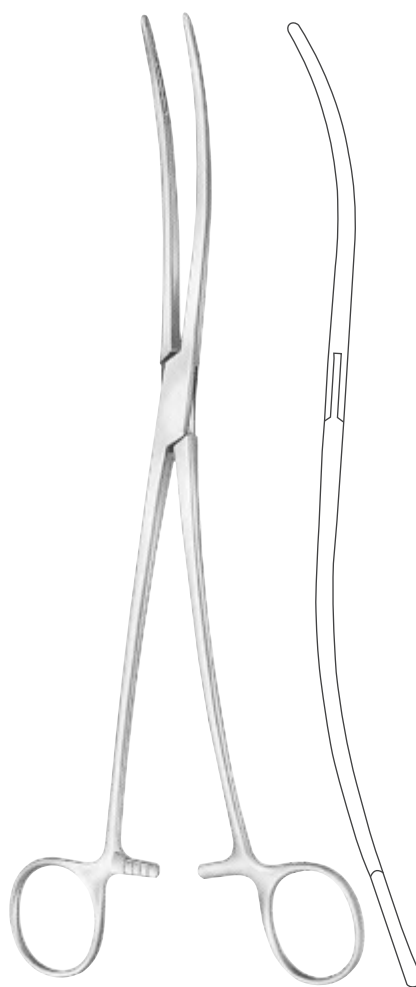

BOZEMANN UTERINE DRESSING FORCEPS
F17-04509
 255mm (10")
 Jaws with longitudinal groove

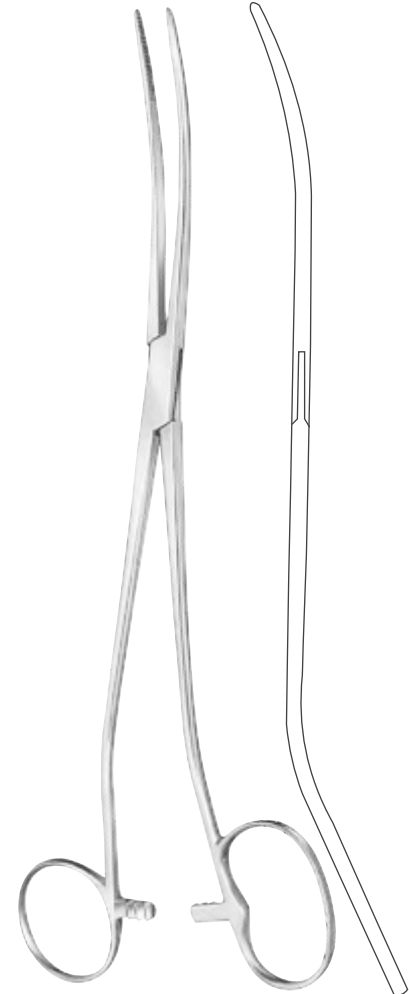

BOZEMANN
F17-04510
 260mm (10.1/4")
 Serrated jaws, on large bow



LISTER - SINUS

DRESSING FORCEPS

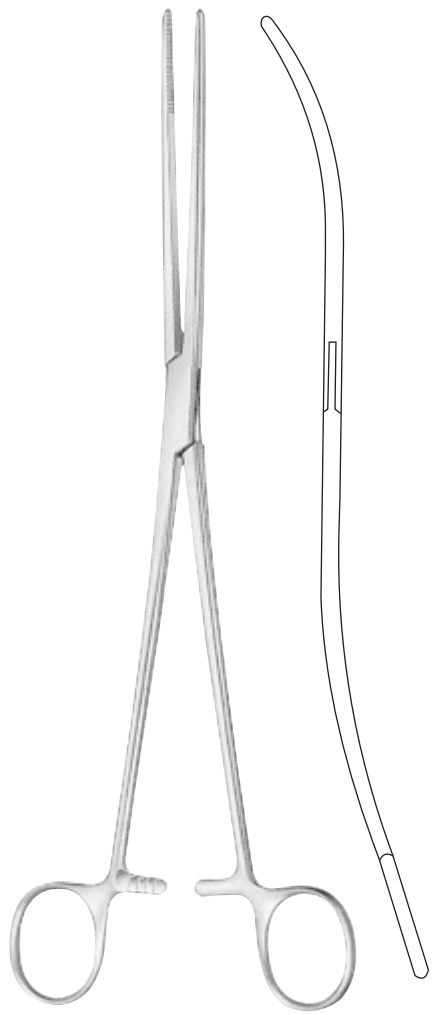

BOZEMANN
F18-04511
 250mm (10")
 S-shaped curve



BOZEMANN
F18-04512
 260mm (10.1/4")
 Straight

F18-04513
 250mm (10")
 Curved

HAEMOSTATS FORCEPS



HALSTEAD MOSQUITO

G1-05100
 100mm (4")
 Straight



HALSTEAD MOSQUITO

G1-05101
 100mm (4")
 Curved on flat



HALSTEAD MOSQUITO

100mm (4")
 1 x 2 teeth

G1-05102
 Straight

G1-05103
 Curved on flat

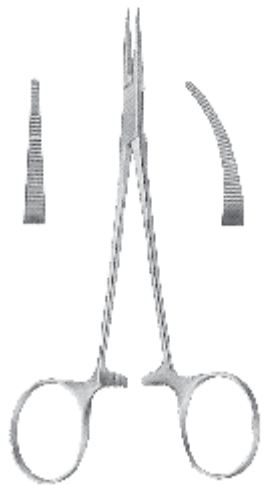

HALSTEAD MOSQUITO

125mm (5")

G1-05104
 Straight

G1-05105
 Curved on flat



HALSTEAD MOSQUITO

125mm (5")
 1 x 2 teeth

G1-05106
 Straight

G1-05107
 Curved on flat



BABY - CRILE

G1-05108
 140mm (5.1/2")
 Straight

HAEMOSTATS FORCEPS



BABY-CRILE

G2-05109
 140mm (5.1/2")
 Curved on flat



BABY-CRILE

G2-05110
 140mm (5.1/2")
 Straight
 1 x 2 teeth



BABY CRILE

G2-05111
 140mm (5.1/2")
 Curved on flat
 1 x 2 teeth



HALSTEAD MOSQUITO
 125mm (5")

G2-05112
 Straight

G2-05113
 Curved on flat

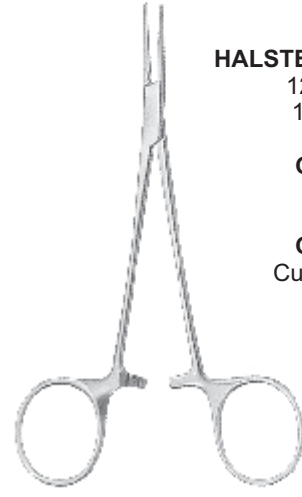

HALSTEAD MOSQUITO
 125mm (5")
 1 x 2 teeth

G2-05114
 Straight

G2-05115
 Curved on flat



GREY TURNER
 Straight

G3-05116
 145mm (5.3/4")

G3-05117
 180mm (7")



GREY TURNER
 Curved on flat

G3-05118
 145mm (5.3/4")

G3-05119
 180mm (7")



CUSHING

G3-05120
 145mm (5.3/4")
 Straight

G3-05121
 145mm (5.3/4")
 Curved on flat

G3-05122
 145mm (5.3/4")
 Curved to side

HAEMOSTATS FORCEPS



CAIRNS

G4-05123
 145mm (5.3/4")

G4-05124
 145mm (5.3/4")
 Curved on flat

G4-05125
 145mm (5.3/4")
 Curved to side



CRAFOORD

G4-05126
 254mm (9.3/4")
 Curved on flat



CRILE
 Straight

G4-05127
 140mm (5.1/2")

G4-05128
 160mm (6.1/4")

G4-05129
 180mm (7")

HAEMOSTATS FORCEPS

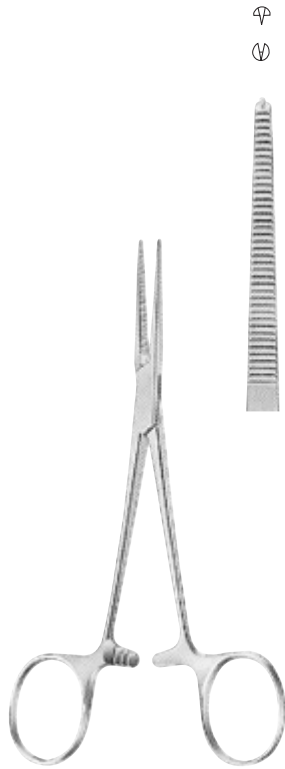

CRILE
 1 x 2 teeth
G5-05130
 160mm (6.1/4")
 Straight

G5-05131
 160mm (6.1/4")
 Curved on flat

G5-05132
 140mm (5.1/2")
 Straight

G5-05133
 140mm (5.1/2")
 Curved on flat



CRILE
 Curved on flat
G5-05134
 140mm (5.1/2")

G5-05135
 160mm (6.1/4")



KELLY-CRILE
 Straight

G5-05136
 140mm (5.1/2")

G5-05137
 160mm (6.1/4")

HAEMOSTATS FORCEPS



KELLY
 Curved on flat

G6-05138
 140mm (5.1/2")

G6-05139
 160mm (6.1/4")



KELLY HALSTEAD

G6-05140
 140mm (5.1/2")
 Straight

G6-05141
 140mm (5.1/2")
 Curved on flat

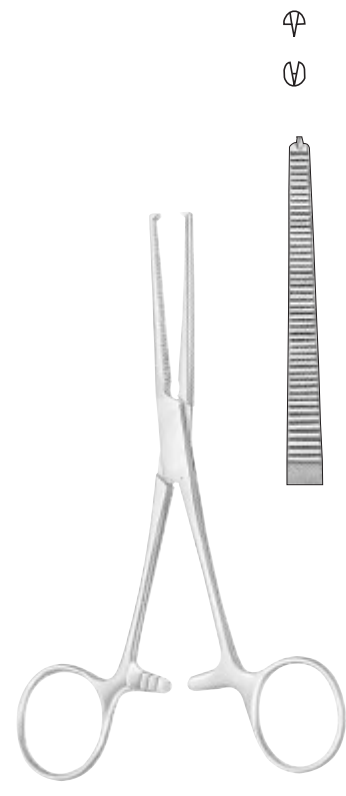

KOCHER
 Straight 1 x 2 teeth

G6-05142
 125mm (5")

G6-05143
 140mm (5.1/2")

G6-05144
 150mm (6")

G6-05145
 180mm (7")

G6-05146
 200mm (8")

G6-05147
 225mm (9")

■ ■ ■ ■ ■

HAEMOSTATS FORCEPS

■ ■ ■ ■ ■

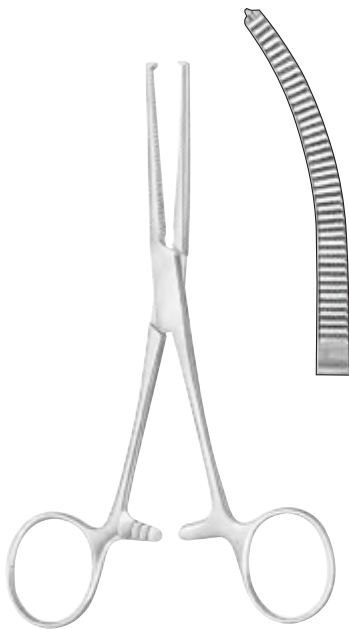

KOCHER
 Curved on flat 1 x 2 teeth

G7-05148
 125mm (5")

G7-05149
 140mm (5.1/2")

G7-05150
 150mm (6")

G7-05151
 180mm (7")

G7-05152
 200mm (8")

G7-05153
 225 (9")



LLOYD DAVIS

G7-05154
 260mm (10.1/4")
 Curved on flat

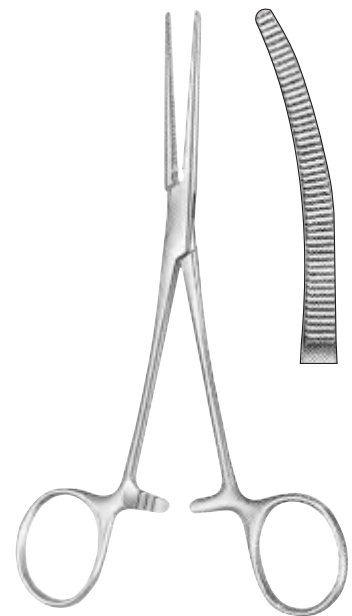

MAYO

G7-05156
 160mm (6.1/4")
 Curved on flat



HAEMOSTATS FORCEPS



ROCHESTER - OSCHNER
 Straight
 1 x 2 teeth

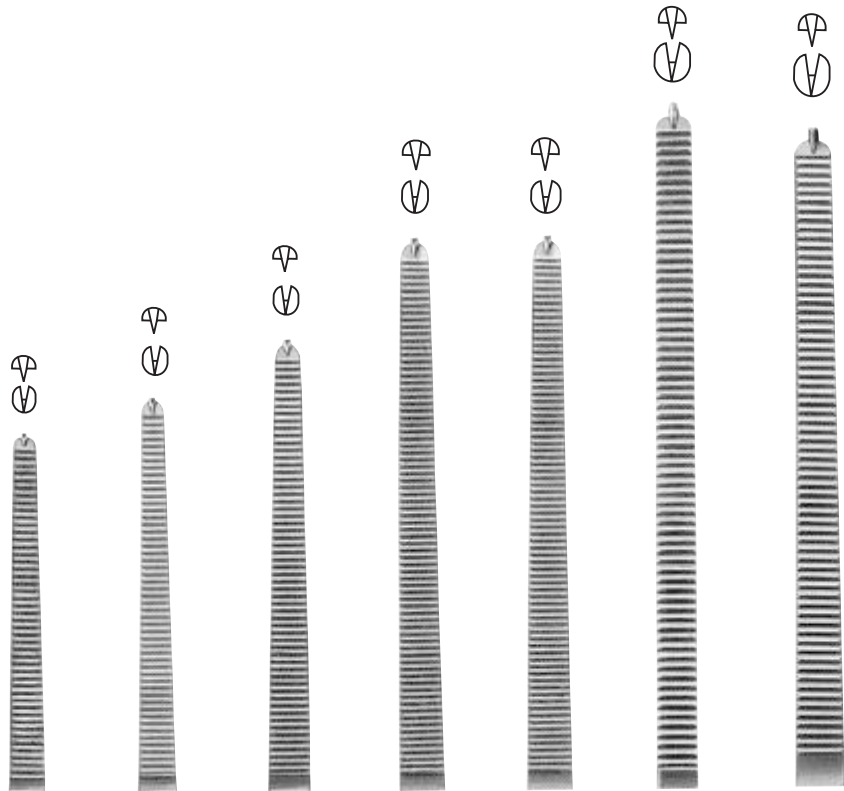

- | | | | | | | |
|-------------------|-------------------|-------------------|-----------------|-----------------|-------------------|--------------------|
| G8-05157 | G8-05158 | G8-05159 | G8-05160 | G8-05161 | G8-05162 | G8-05163 |
| 140mm
(5.1/2") | 160mm
(6.1/4") | 185mm
(7.1/4") | 200mm
(8") | 225mm
(9") | 240mm
(9.1/2") | 260mm
(10.1/4") |



HAEMOSTATS FORCEPS

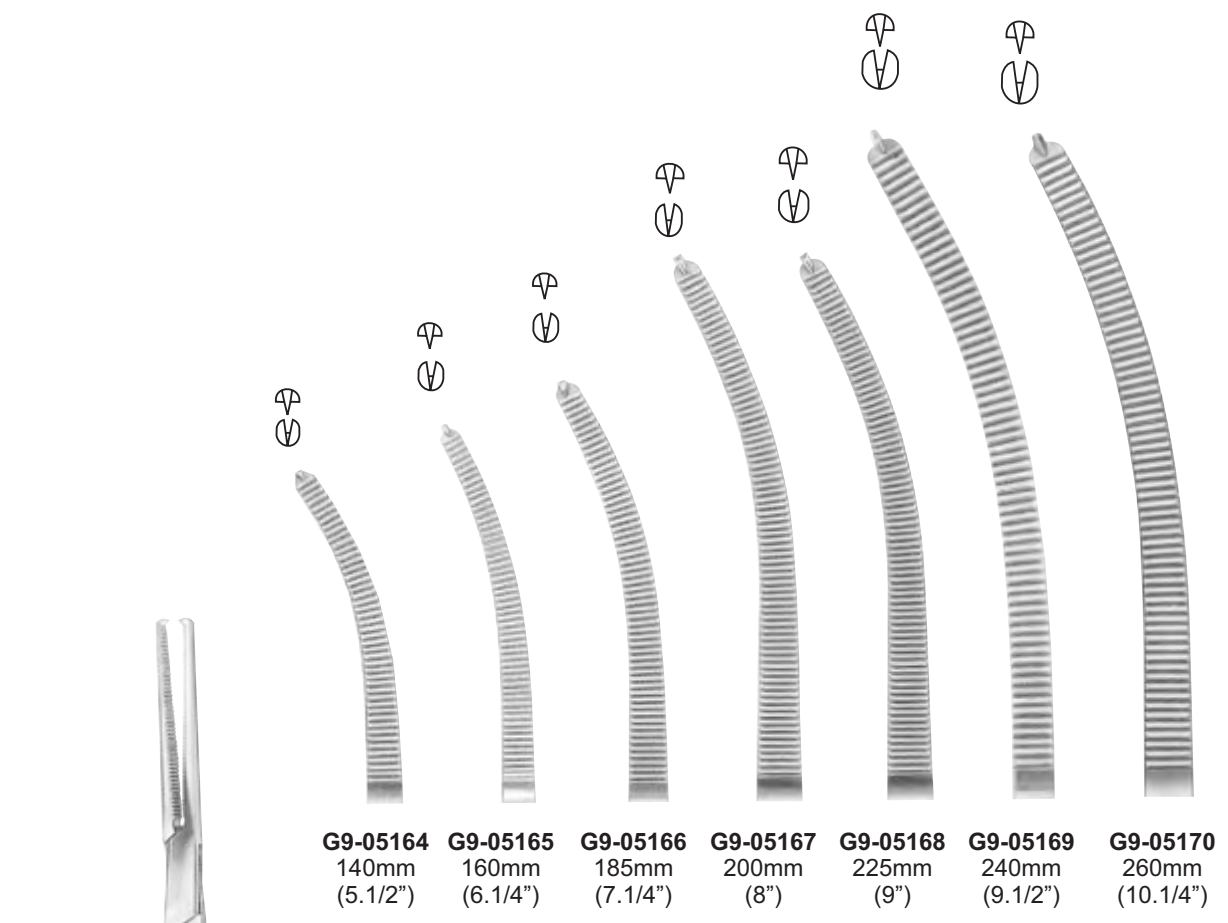

G9-05164	G9-05165	G9-05166	G9-05167	G9-05168	G9-05169	G9-05170
140mm	160mm	185mm	200mm	225mm	240mm	260mm
(5.1/2")	(6.1/4")	(7.1/4")	(8")	(9")	(9.1/2")	(10.1/4")



ROCHESTER - OSCHNER
 Curved
 1 x 2 teeth

INSTRUMENTS

HAEMOSTATS FORCEPS



G10-05172
 180mm (7")
 Curved on flat



G10-05173
 180mm (7")
 Straight



G10-05174
 185mm (7.1/4")
 Curved on flat
 1 x 2 teeth



G10-05175
 185mm (7.1/4")
 Straight
 1 x 2 teeth



FRASER - ADSON



FRASER-KELLY (CRILE)

G10-05171
 180mm (7")
 Curved on flat



DUNHILL

G10-05176
 125mm (5")
 Curved on flat

G10-05177
 125mm (5")
 Straight

G10-05178
 180mm (7")
 Curved on flat

HAEMOSTATS FORCEPS



SPENCER WELLS
 Straight

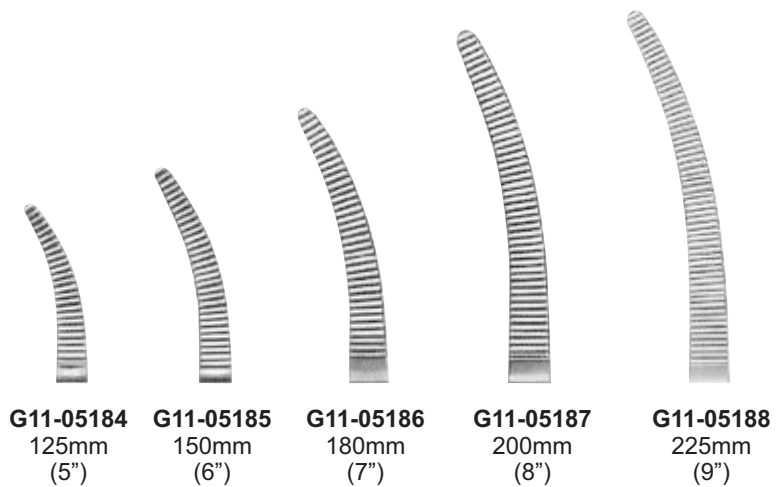
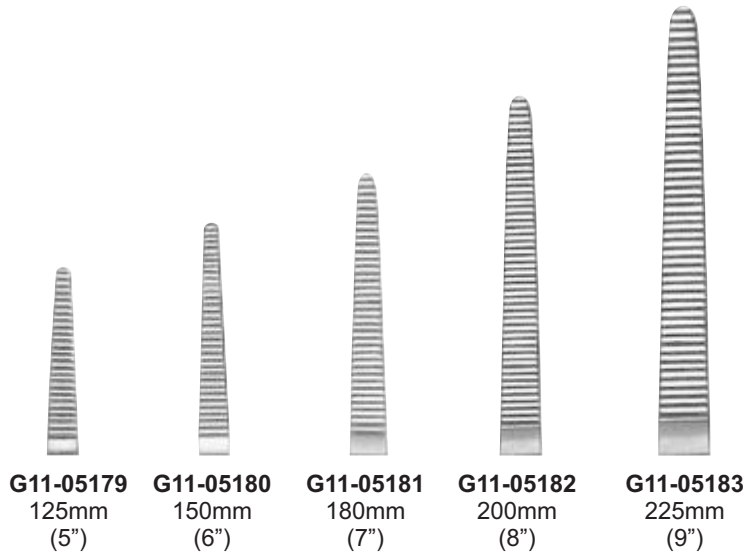

SPENCER WELLS
 Curved on flat

HAEMOSTATS FORCEPS



ROCHSTER PEAN
 Straight

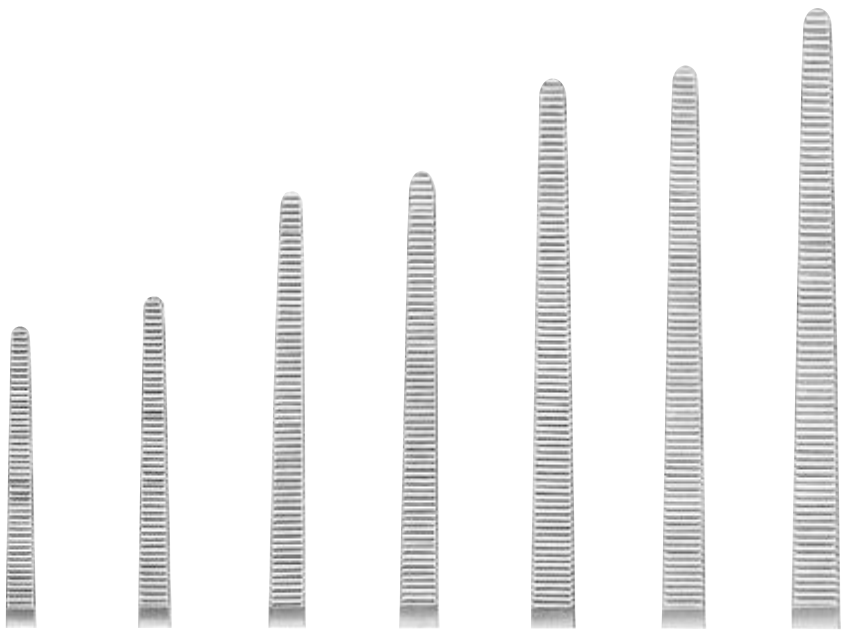

- | | | | | | | |
|-------------------|-------------------|-------------------|------------------|------------------|-------------------|--------------------|
| G12-05189 | G12-05190 | G12-05191 | G12-05192 | G12-05193 | G12-05194 | G12-5195 |
| 140mm
(5.1/2") | 160mm
(6.1/4") | 185mm
(7.1/4") | 200mm
(8") | 225mm
(9") | 240mm
(9.1/2") | 260mm
(10.1/4") |

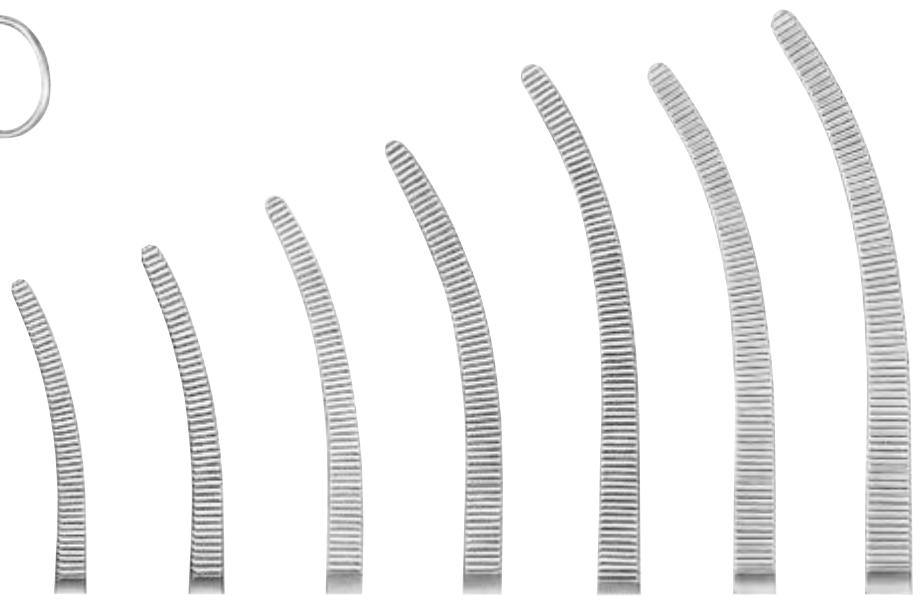

- | | | | | | | |
|-------------------|-------------------|-------------------|------------------|------------------|-------------------|--------------------|
| G12-05196 | G12-05197 | G12-05198 | G12-05199 | G12-05200 | G12-05201 | G12-05202 |
| 140mm
(5.1/2") | 160mm
(6.1/4") | 185mm
(7.1/4") | 200mm
(8") | 225mm
(9") | 240mm
(9.1/2") | 260mm
(10.1/4") |

ROCHSTER PEAN
 Curved on flat

HAEMOSTATS FORCEPS



HEISS

G13-05203
 200mm (8")
 Straight

G13-05204
 200mm (8")
 Curved on side

G13-05205
 200mm (8")
 Straight 1 x 2 teeth

G13-05206
 200mm (8")
 Curved on flat 1 x 2 teeth

BIRKETT

G13-05207
 180mm (7")
 Straight

G13-05208
 180mm (7")
 Curved to side

G13-05209
 180mm (7")
 Curved on flat

ROBERTS
 Curved on flat

G13-05210
 230mm (9")
 Screw joint

G13-05211
 230mm (9")
 Box joint

TONSIL ARTERY FORCEPS

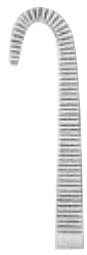

G14-05213



G14-05214



SCHNIDT TONSIL

G14-05212
 180mm (7")
 Slight curved on flat



NEGUS TONSIL

G14-05213
 180mm (7")
 Small curved

G14-05214
 180mm (7")
 Large curved



WILSON TONSIL

G14-05215
 190mm (7.1/2")
 Curved on flat
 Angled shafts

HAEMOSTATS FORCEPS



G15-05216
 140mm (5.1/2")

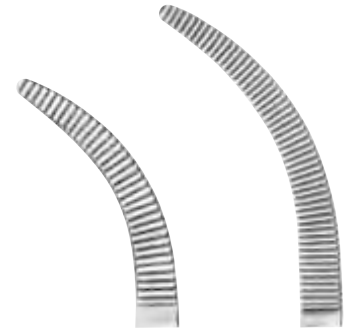

G15-05219 **G15-05220**

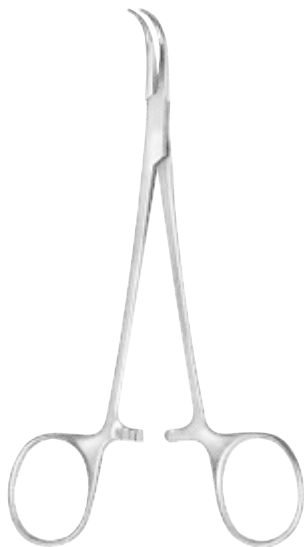

MIXTER
 Curved on flat



G15-05217
 180mm (7")



G15-05218
 230mm (9")



MOYNIHAN

G15-05219
 230mm (9")

G15-05220
 240mm (9.1/2")



HAEMOSTATS FORCEPS



- G16-05221**
 150mm
 (6")
- G16-05222**
 180mm
 (7")
- G16-05223**
 200mm
 (8")
- G16-05224**
 230mm
 (9")
- G16-05225**
 255mm
 (10")

O'SHAUGHNESSY
 Curved, lightweight



TUBING CLAMP
 Heavy pattern.
 wedge jaw

- G16-05226**
150mm (6")
- G16-05227**
180mm (7")
- G16-05228**
200mm (8")



- G16-05229**
- G16-05230**

FICKLING ORAL

- G16-05229**
180mm (7")
Angled to side
1 x 2 teeth
- G16-05230**
180mm (7")
Angled to side

DISSECTING & LIGATURE FORCEPS



LIGATURE FORCEPS

G17-05231
 95mm (3.3/4")
 Straight, smooth jaw



MICRO ADSON

G17-045232
 140mm (5.1/2")



G17-05233
 185mm (7.1/4")



G17-05234
 210mm (8.1/4")



BABY - ADSON



G17-05235
 140mm
 (5.1/2")



G17-05236
 180mm
 (7")



S.SHAPED DELICATE

DISSECTING & LIGATURE FORCEPS



G18-05237
 215mm (8.1/2")



G18-05238
 210mm (8.1/4")



G18-05239
 220mm (8.3/4")



G18-05240
 225mm (9")



G18-05241
 225mm (9")



G18-05242
 295mm (11.3/4")



G18-05243
 295mm (11.3/4")



**FINE CURVED DISSECTING
 FORCEPS**

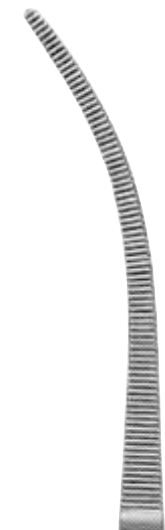

G18-05244
 300mm (12")

DISSECTING & LIGATURE FORCEPS

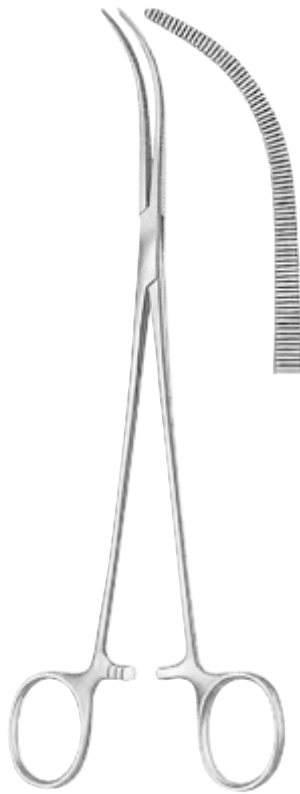

MIXTER
 G19-05245
 200mm (8")



LAWRENCE
 G19-05246
 270mm (10.3/4")

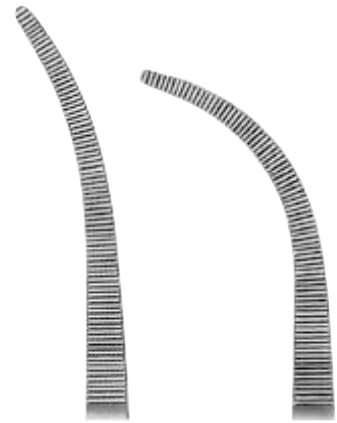

G19-05247
 300mm
 (12")

G19-05248
 290mm
 (11.1/2")



LONG CURVED FORCEPS



TISSUE FORCEPS



ALLIS
150mm (6")

G20-05250
2 x 3 teeth

G20-05251
3 x 4 teeth

G20-05252
4 x 5 teeth

G20-05253
5 x 6 teeth

G20-05254
6 x 7 teeth



G20-05255



G20-05256



AMERICAN PATTERN ALLIS

G20-05249
150mm (6")
3 x 4 teeth

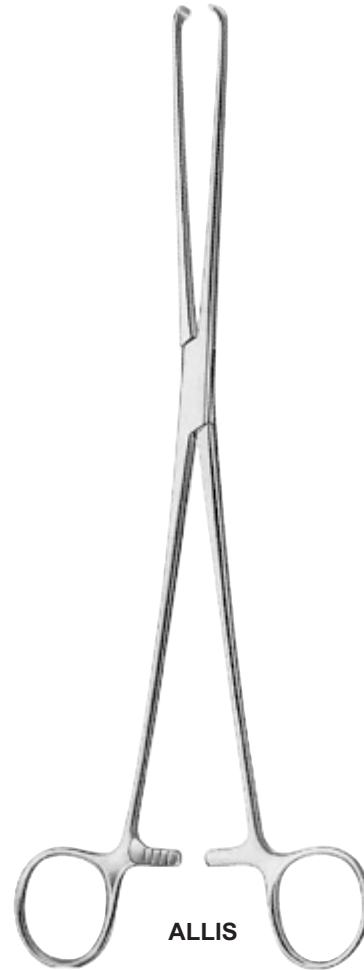

ALLIS

G20-05255
190mm (7.1/2")

G20-05256
255mm (10")
5 x 6 Teeth



TISSUE FORCEPS

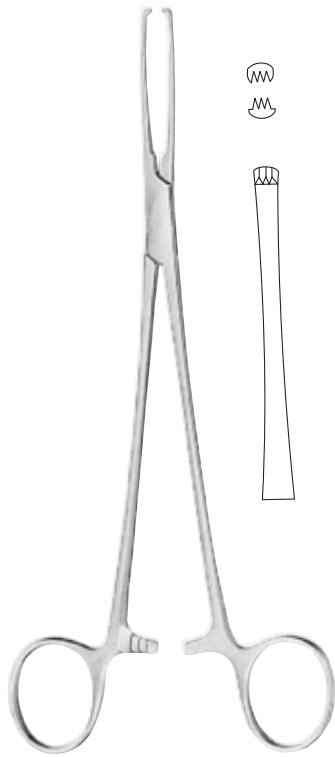

JUD-ALLIS

G21-05257
 195mm (7.3/4")
 Light pattern, 3 x 4 teeth

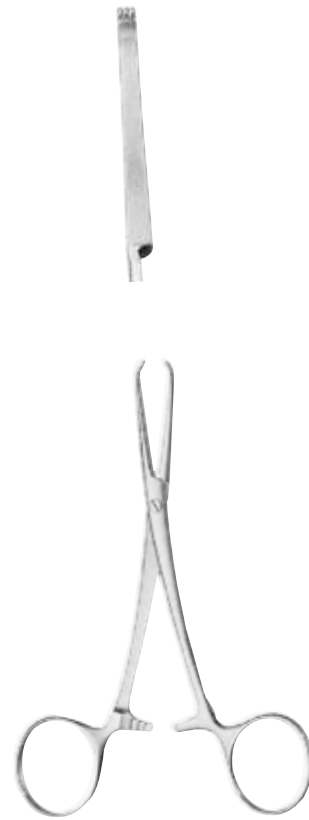

CHAPUT (POIRIER)

G21-05258
 125mm (5")
 2 x 3 teeth



TISSUE FORCEPS

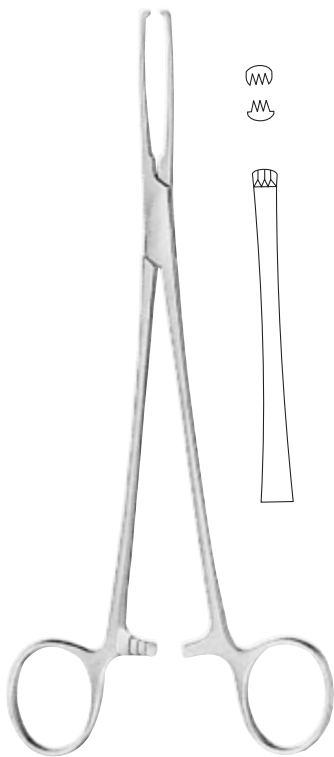

JUD-ALLIS

G21-05257
195mm (7.3/4")
Light pattern, 3 x 4 teeth



CHAPUT (POIRIER)

G21-05258
125mm (5")
2 x 3 teeth



LITTLEWOOD

G21-05259
185mm (7.1/4")
2 x 3 teeth



TISSUE FORCEPS



LITTLEWOOD

G22-05259
 185mm (7.1/4")
 2 x 3 teeth



TUBING CLAMP

G22-05260
 175mm (7")

G22-05261
 200mm (8")



MICRO NEEDLE HOLDERS



CASTROVIEJO

H1-06100
 145mm (5.3/4")
 With catch



CASTROVIEJO

H1-06101
 145mm (5.3/4")
 With catch



ARRUGA

H1-06102
 135mm (5.1/4")



BARRAQUER

H1-06103
 120mm (4.3/4")
 With catch



BARRAQUER

H1-06104
 120mm (4.3/4")
 Without catch



NEEDLE HOLDERS

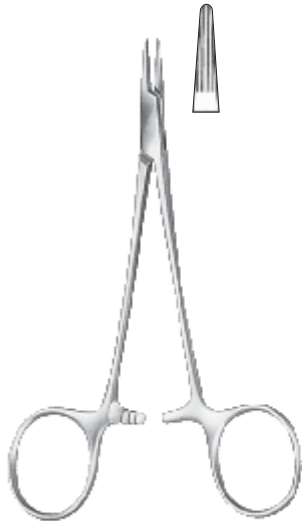

CONVERSE

H2-06105
 125mm (5")



DERF

H2-06106
 120mm (4.3/4")



MAYO (DUNHILL)

H2-06107
 160mm (6.1/4")



MAYO

H2-06108
 180mm (7")



MAYO

H2-06109
 190mm (7.1/2")

NEEDLE HOLDERS



CRILE WOOD

H3-06110
150mm (6")



CRILE MURRAY

H3-06111
145mm (5.3/4")



NAUNTON MORGAN

H3-06112
190mm (7.1/2")

H3-06113
250mm (10")

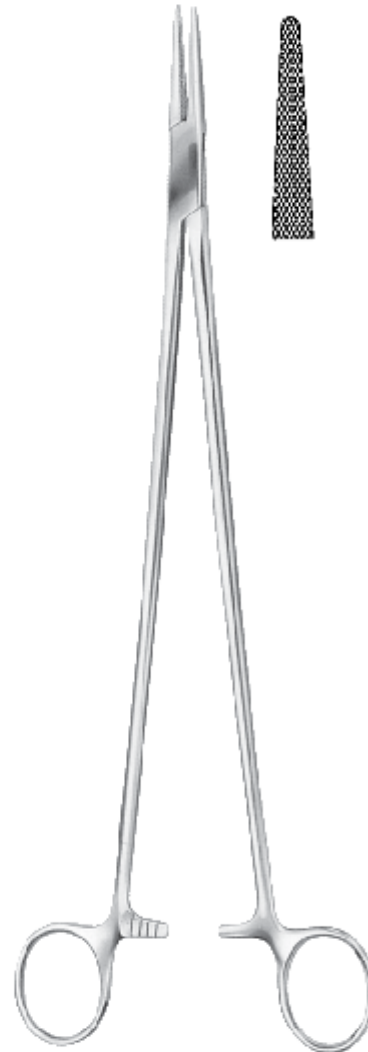

WANGENSTEEN

H3-06114
270mm (10.3/4")

■ ■ ■ ■ ■
NEEDLE HOLDERS



JAMESON
H4-06115
 230mm (9")



WRIGHT
H4-06116
 125mm (5")



GILLIES
 Combined needle holder
 and scissors
H4-06119
 160mm (6.1/4")



KILNER
H4-06117
 135mm (5.1/4")



HEANEY
H4-06118
 200mm (8")



NEEDLE HOLDERS

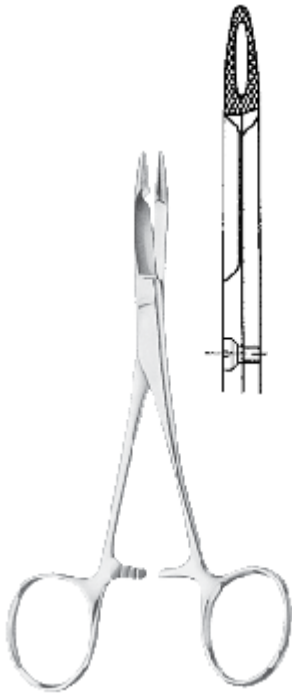

OLSEN HEGAR
Combined needle holder
and scissors

H5-06120
140mm (5.1/2")

H5-06121
165mm (6.1/2")

H5-06122
190mm (7.1/2")

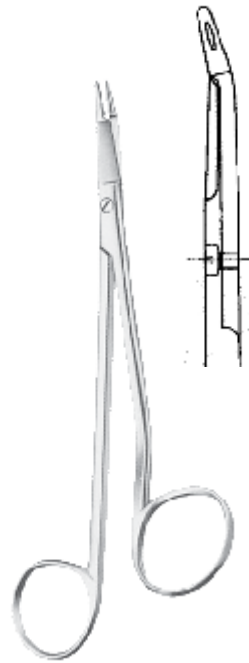

WARD
Combined needle holder
and scissors

H5-06123
180mm (7")





NEEDLE HOLDERS



MAYO (BAUMGARTNER)



H6-06124
 140mm (5.1/2")

MAYO (MASSON)



H6-06125
 265mm (10.1/2")

MAYO



H6-06126
 165mm (6.1/2")



H6-06127
 190mm (7.1/2")



H6-06128
 200mm (8")



H6-06129
 230mm (9")

HEGAR



H6-06130
 200mm (8")





NEEDLE HOLDERS



HALSEY

H7-06131
125mm (5")



MATHIEU

H7-06132
140mm (5.1/2")



MATHIEU

H7-06133
170mm (6.3/4")



MATHIEU

H7-06134
200mm (8")



NEEDLE HOLDERS



WEBSTER
 Smooth Jaw

H8-06135
 115mm (4.1/2")



LAWRANCE

H8-06136
 150mm (6")
 Lightweight

H8-06137
 150mm (6")



MAYO

H8-06138
 150mm (6")



MCPHAILS

H8-06139
 180mm (7")

“TC” NEEDLE HOLDERS

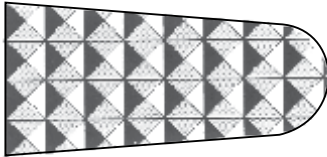

COARSE

For powerful needle holder patterns and wire twisters

Maximum holding capabilities for heavy needles or wire

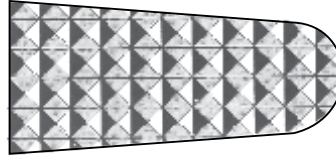

STANDARD

Used for example Mayo-Hegar, Mathieu Needle Holders

For needle 3-0 and larger

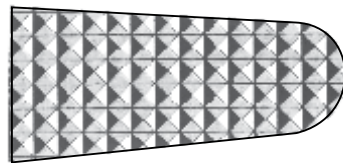

FINE

For delicate needle holders such as Crile Wood and Debakey

For needle and sutures between 4-0 and 6-0

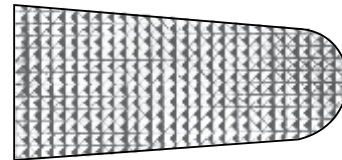

MICRO

For micro needle holder such as Castroviejo, Microvascular and Mini-Ryder

For delicate needle and sutures between 7-0 and 10-0



CASTROVIEJO

I1-06200
 145mm (5.3/4")



CASTROVIEJO

I1-06201
 145mm (5.3/4")



CASTROVIEJO

I1-06202
 180mm (7")



CASTROVIEJO

I1-06203
 215mm (8.1/2")

"TC" NEEDLE HOLDERS

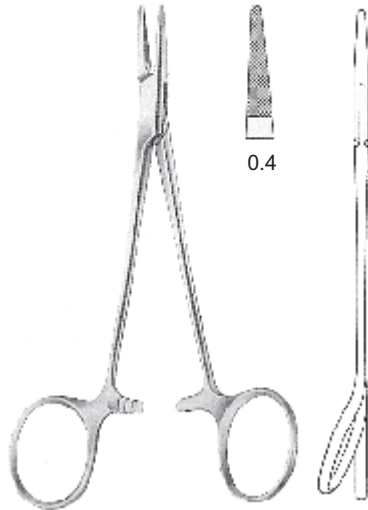

MASING
I 2-06204
 130mm (5.1/8")
 One ring angled

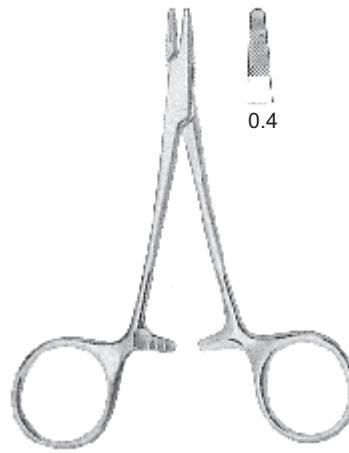

DERF
I 2-06205
 115mm (4.1/2")

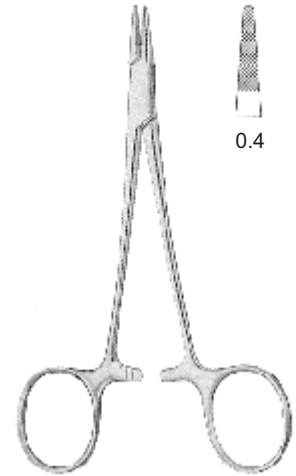

MASING
I 2-06206
 125mm (5")



CRILE - WOOD



I 2-06207
 180mm
 (7")



I 2-06208
 200mm
 (8")



I 2-06209
 305mm
 (12.1/4")

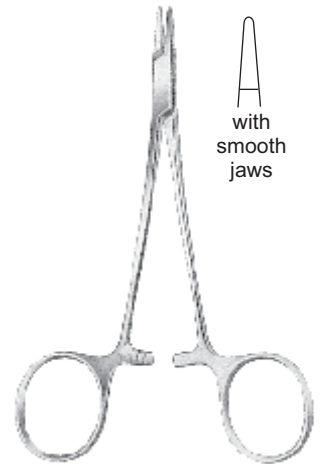

HALSEY
I 2-06210
 120mm (4.3/4")
 with smooth jaws

“TC” NEEDLE HOLDERS



CONVERSE
I 3-06211
 130mm (5.1/8")

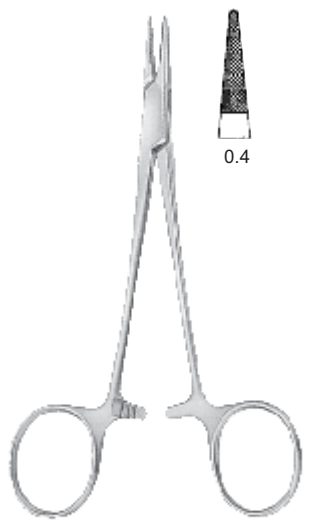

HALSEY
I 3-06212
 130mm (5.1/8")



BABY-CRILE-WOOD
I 3-06213
 150mm (6")



WEBSTER
I 3-06214
 125mm (5")

With
 Smooth
 Jaws



BAUMGARTNER
I 3-06215
 145mm (5.3/4")

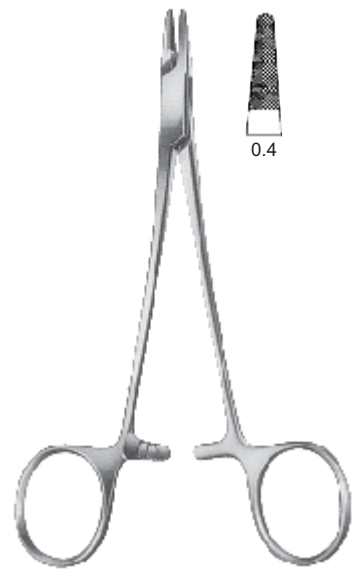

CRILE - WOOD
I 3-06216
 145mm (5.3/4")

"TC" NEEDLE HOLDERS

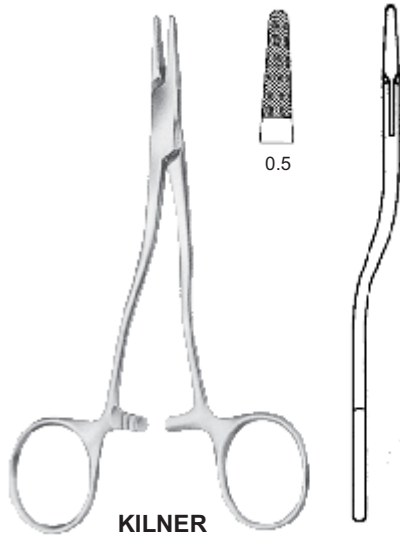

KILNER

I 4-06217
 135mm (5.1/4")



SAROT

I 4-06218
 175mm (7")

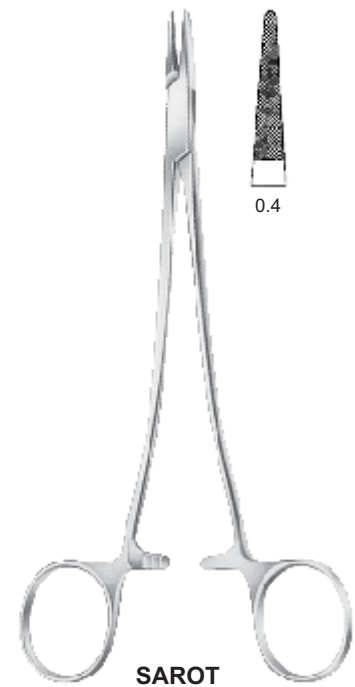

SAROT

I 4-06219
 260mm (10.1/4")



HAGAR-MAYO

I 4-06220
 200mm (8")

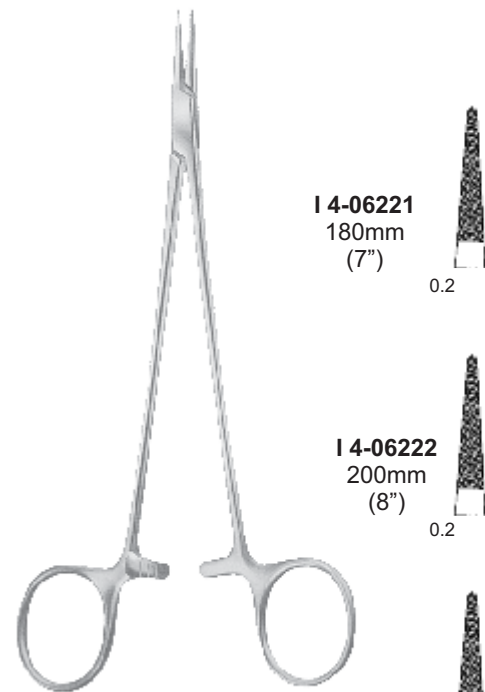

Very Delicate

I 4-06221
 180mm
 (7")

I 4-06222
 200mm
 (8")

I 4-06223
 230mm
 (9")



“TC” NEEDLE HOLDERS

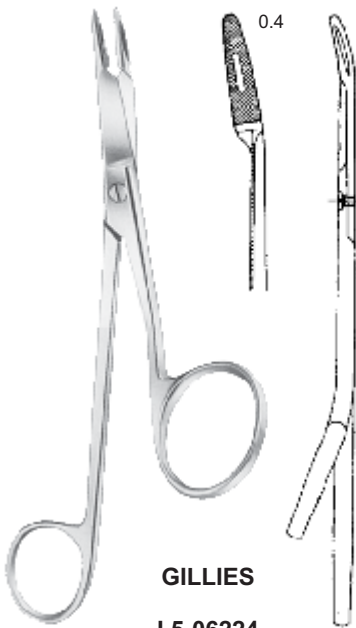

GILLIES
I 5-06224
 160mm (6.1/4")



DEBAKEY
 Very Delicate

I 5-06225
 165mm (6.1/2")



I 5-06226
 210mm (8.1/4")



I 5-06227
 165mm (6.1/2")



I 5-06228
 210mm (8.1/4")



DEBAKEY
I 5-06229
 150mm (6")

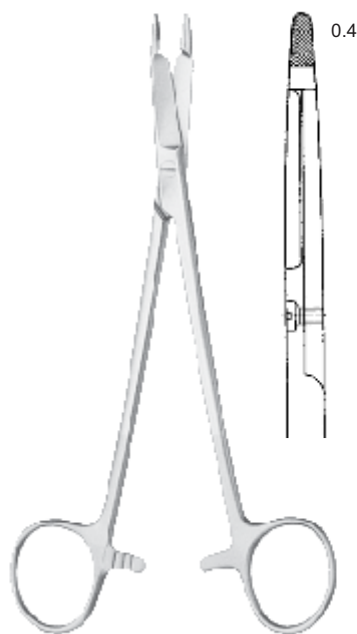

HAGER-OSLEN
I 5-06230
 165mm (6.1/2")

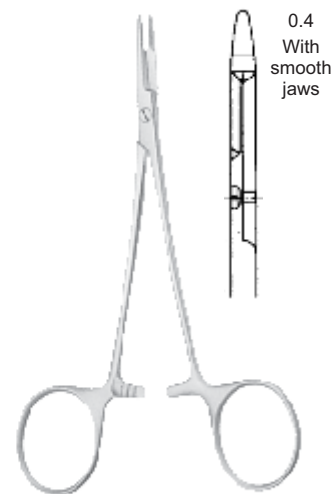

**COMBINED SCISSOR AND
 NEEDLE HOLDER**
I 5-06231
 125mm (5")



■ ■ ■ ■ ■
“TC” NEEDLE HOLDERS ■ ■ ■ ■



DEBAKEY
 Delicate



I 6-06232
 180mm (7")



I 6-06233
 230mm (9")



I 6-06234
 250mm (10")



I 6-06235
 305mm (12")



“TC” NEEDLE HOLDERS



RYDER (FRENCH EYE)



I 7-06236
125mm (5")



I 7-06237
150mm (6")



I 7-06238
180mm (7")



I 7-06239
200mm (8")



I 7-06240
230mm (9")



I 7-06241
250mm (10")



RYDER (MICRO)



I 7-06242
125mm (5")



I 7-06243
150mm (6")



I 7-06244
180mm (7")



I 7-06245
200mm (8")



I 7-06246
230mm (9")



"TC" NEEDLE HOLDERS

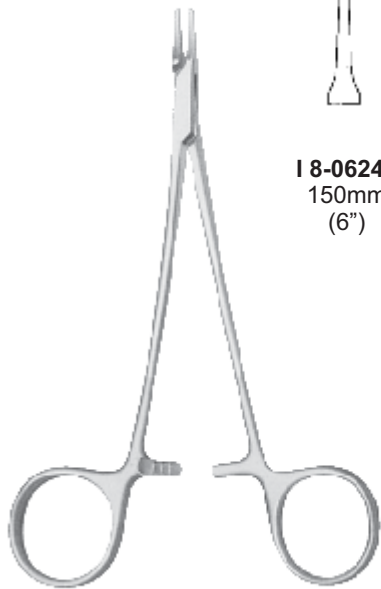

RYDER
 With smooth jaw



I 8-06247
 150mm
 (6")

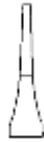

I 8-06248
 180mm
 (7")

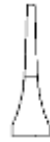

I 8-6249
 230mm
 (9")

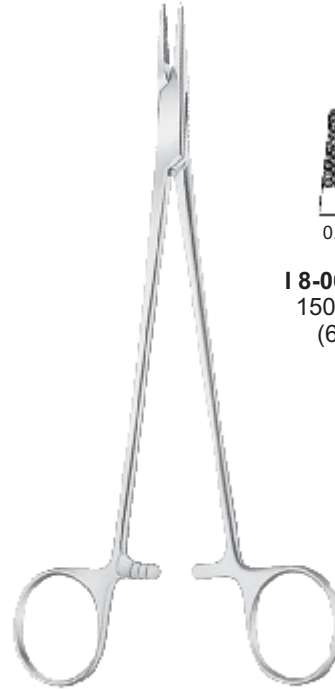

MAYO-HEGAR



I 8-06250
 150mm
 (6")



I 8-06251
 180mm
 (7")



I 8-06252
 205mm
 (8")



MAYO-HEGAR



I 8-06253
 300mm
 (12")

“TC” NEEDLE HOLDERS

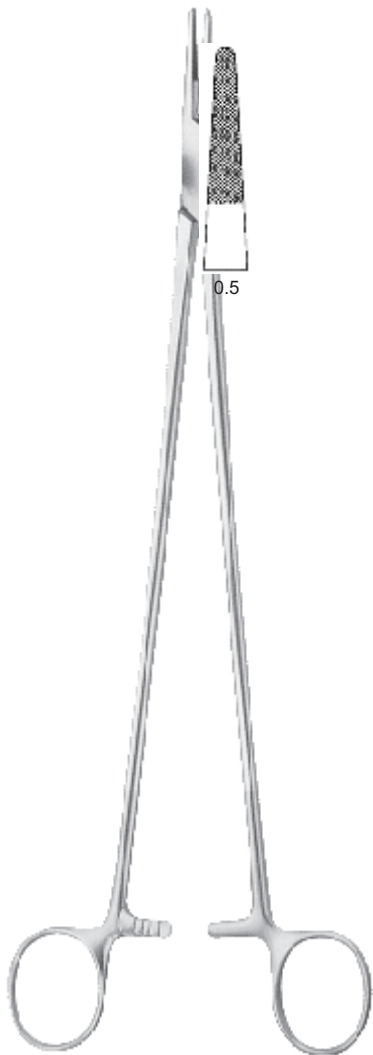

WANGENSTEEN

I 9-06254
 275mm (10.3/4")

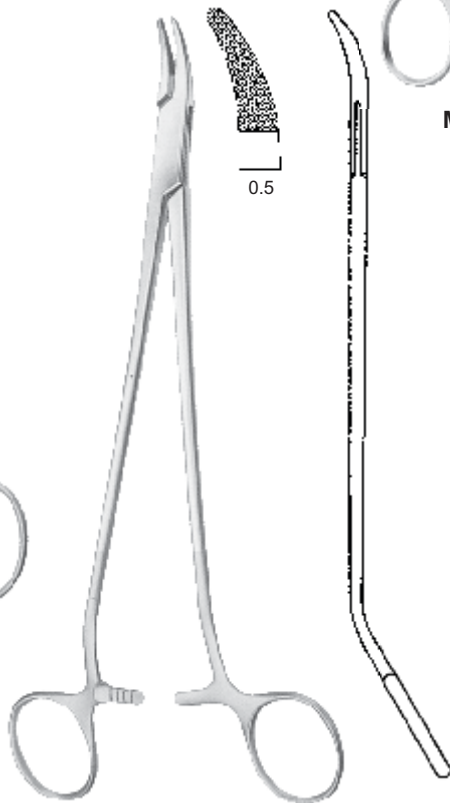

THOMSON-WALKER

I 9-06257
 215mm (8.1/2")
 S. Shaped

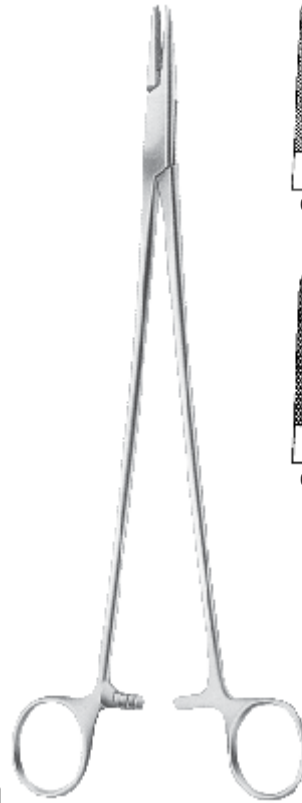

MAYO-HEGAR
 Heavy Pattern

I 9-06255
 205mm (8")

I 9-06256
 145mm (9.3/4")

“TC” NEEDLE HOLDERS



HEANEY

I 10-06258
 200mm (8")
 Curved on flat



HEANEY

I 10-06259
 260mm (10.1/4")



NAUNTUN MORGAN

I 10-06260
 260mm (10.1/4")

“TC” NEEDLE HOLDERS



MASSON
I 11-06261
265mm (10.1/2")



FINOCHIETTO
I 11-06262
265mm (10.1/2")

"TC" NEEDLE HOLDERS



WERTHEIM



I 12-06263
 200mm (8")



I 12-06264
 240mm (9.1/2")



I 12-06265
 300mm (12")



I 12-06266
 150mm
 (6")

Wire Twister, Round jaw



I 12-06267
 190mm
 (7.1/2")

BERRY



I 12-06268
 200mm
 (8")

BAUMGARTNER
 Wire Twister, Square jaw



“TC” NEEDLE HOLDERS

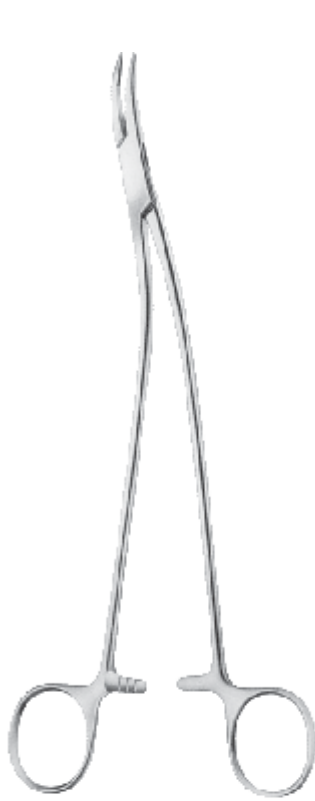

STRATTE

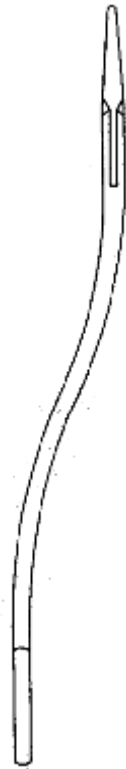

I 13-06269
 210mm (8.1/4")



I 13-06270
 230mm (9")



I 13-06274
 275mm (10.3/4")



MATHIEU
 Delicate pattern



I 13-06271
 200mm (8")



I 13-06272
 240mm (9.1/2")



I 13-06273
 300mm (12")



"TC" NEEDLE HOLDERS



I 14-06275
 195mm (7.3/4")
 Elastic pattern, delicate



I 14-06276
 200mm (8")



I 14-06277
 140mm (5.1/2")



I 14-06278
 170mm (6.3/4")



I 14-06279
 200mm (8")



HOESEL
I 14-06280
 260mm (10.1/4")
 With long neck

MATHIEU-STANDARD

“TC” NEEDLE HOLDERS



ZWEIFEL



0.5

I 15-06281
 200mm (8")
 Heavy pattern for
 sternum suture



MATHIEU
 Heavy pattern



0.5

I 15-06282
 200mm (8")



0.5

I 15-06283
 245mm (9.3/4")



0.4

I 15-06284
 200mm (8")



0.4

I 15-06285
 260mm (10.1/4")

With long neck



ZWEIFEL



0.5

I 15-06286
 180mm (7")



0.5

I 15-06287
 230mm (9")

"TC" NEEDLE HOLDERS



I 16-06288
 200mm (8")

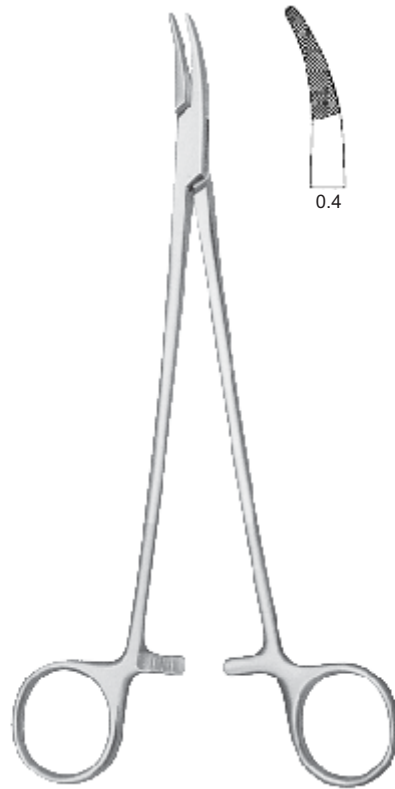

JULIAN
I 16-06289
 200mm (8")



TOENNIS
I 16-06290
 185mm (7.1/4")

“TC” NEEDLE HOLDERS



LANGENBECK



I 17-06291
 180mm (7")



I 17-06292
 200mm (8")



TOENNIS

I 17-06293
 180mm (7")
 Elastic pattern



"TC" NEEDLE HOLDERS



LAWRANCE

I 18-06294
 150mm (6")
 Lightweight

I 18-066295
 150mm (6")



LANGENBECK
 Delicate

I 18-06296
 200mm (8")

I 18-06297
 260mm (10.1/4")

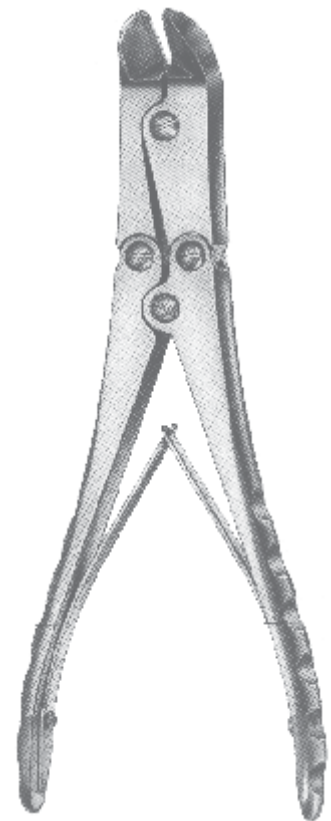

WIRE CUTTER
 with tungsten carbide inserts

I 18-06298
 150mm (6")

I 18-06299
 200mm (8")



OPHTHALMOLOGY



J1-07100
 BARRAQUER
 30mm (1.1/4")
 40mm (.3/4")



J1-07101
 BOWMAN
 70mm (2.3/4")

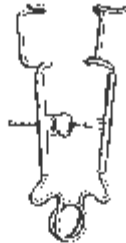

J1-07102
 CRITCHETT
 70mm (2.3/4")



J1-07103
 SMITH
 50mm (2")

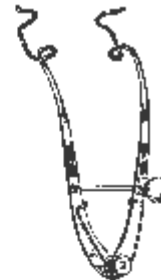

J1-07104
 CLARK
 80mm (3.1/4")



J1-07105
 GRAEFE
 70mm (2.3/4")
 90mm (3.1/2")



J1-07106
 WEEK
 80mm (3.21/4")

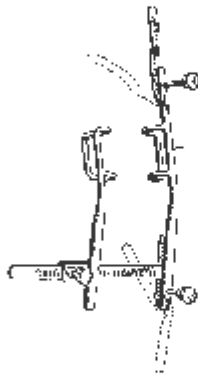

J1-07107
 ARRUGA
 70mm (2.3/4")
 Rechts

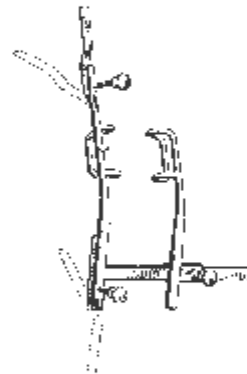

J1-07108
 ARRUGA
 70mm (2.3/4")
 Links



J1-07109
 MURDOCK
 50mm (2")



J1-07110
 MELLINGER
 AXENFELD
 70mm (2.3/4")

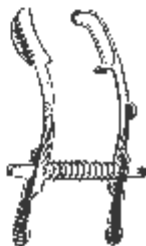

J1-07111
 MELLINGER
 AXENFELD
 70mm (2.3/4")

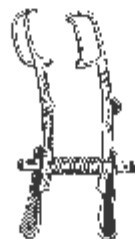

J1-07112
 MELLINGER
 50mm (2")
 70mm (2.3/4")



J1-07113
 LISTER BURCH
 80mm (3.1/4")



J1-07114
 WILLIAMS
 80mm (3.1/4")



OPHTHALMOLOGY

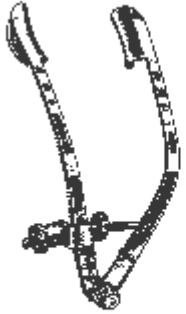

J2-07115
 LANCASTER
 70mm (2.3/4")



J2-07116
 ZIEGLER
 70mm (2.3/4")



J2-07117
 CASTROVIEJO
 80mm (3.1/4")

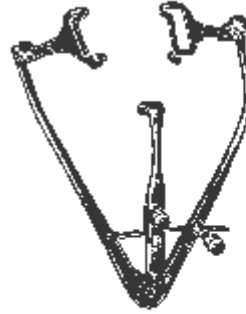

J2-07118
 PARK
 80mm (3.1/4")



J2-07119
 MUELLER
 70mm (2.3/4")



J2-07120
 GOLDSTEIN
 30mm (1.1/4")



J2-07121
 STEVENSON
 70mm (2.3/4")



J2-07122
 JAEGER
 110mm (4.1/2")



GRAEFE



J2-07123
 Fig. 0



J2-07124
 Fig. 1



J2-07125
 Fig. 2



J2-07126
 Fig. 3



J2-07127
 DEUTSCHMANN
 130mm (5.1/4")



OPHTHALMOLOGY

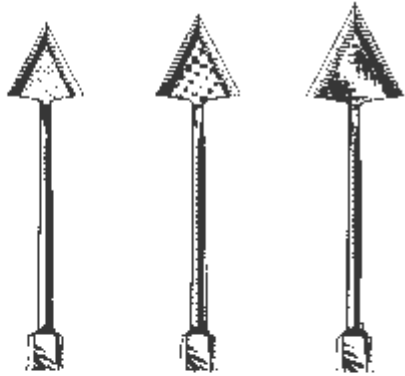

JAEGER

J3-07128 Fig. 1
J3-07129 Fig. 2
J3-07130 Fig. 3

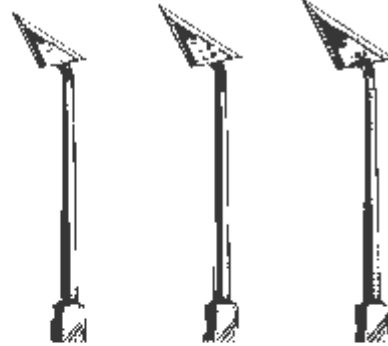

JAEGER 45°

J3-07131 Fig. 1
J3-07132 Fig. 2
J3-07133 Fig. 3



J3-07134
BERENS
 130mm (5.1/4")

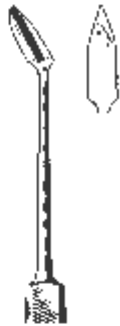

J3-07135
CASTROVIEJO
 130mm (5.1/4")



J3-07136
GRAEFE
 130mm (5.1/4")

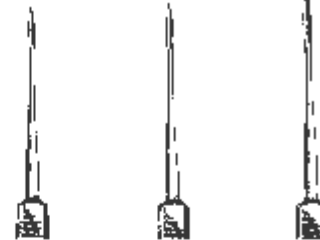

KNAPP

J3-07137 Fig. 1
J3-07138 Fig. 2
J3-07139 Fig. 3



ZIEGLER

J3-07140
 Fig. 1
 5mm



J3-07141
 Fig. 2
 6mm



J3-07142
 Fig. 3
 7mm



J3-07143
DEAN
 125mm(5")



BOWMAN

J3-07144
 0.4mm
 130mm (5.1/4")





























J3-07145
 0.8mm
 130mm (5.1/4")



J3-07146
WHEELER
 120mm (4.3/4")



OPHTHALMOLOGY

- | | | | | | | |
|--|---|---|---|--|--|--|
| 
J4-07147
ZIEGLER
110mm (4.1/2") | 
J4-07148
SATO
125mm (5") | 
J4-07149
TOOK
120mm (4.3/4") | 
J4-07150
GILL
120mm (4.3/4") | 
J4-07151
ELSCHING
130mm (5.1/4") | 
J4-07152
KUHN
Fig 1 | |
| 
J4-07153
KUHN
Fig 2 | 
J4-07154
KUHN
Fig 3 | 
J4-07155
KUHN
Fig 4 | 
J4-07156
PATON
120mm (4.3/4") | 
J4-07157
LUNDSGAARD
120mm (4.3/4") | 
J4-07158
GUYTON
LUNDSGAARD | 
J4-07159
BARRKAN |
| 
J4-07160
SCHEIE | 
J4-07161
BURCH | 
J4-07162
PAUFIQUE | 
J4-07163
BARRAQUER | 
J4-07164 | 
J4-07165 | |
| 
J4-07166
BOWMAN | 
J4-07167
BOWMAN | 
J4-07168 | 
J4-07169 | 
J4-07170
LEVINSON | 
J4-07171
FRANCIS | 
J4-07172
DAVIS
130mm (5.1/4") |



OPHTHALMOLOGY



J5-07173
LA FORCE



J5-07174
DIX

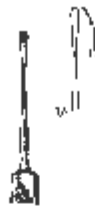

J5-07175
ELLIS



J5-07176
WALTON

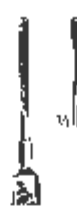

J5-07177
WALTON



J5-07178
ALVIS



J5-07179
GREEN



J5-07180
ROLLET



J5-07181
Fig. 1



J5-07182
Fig. 2



J5-07183
Fig. 3



J5-07184
JAMESON



J5-07185
GREEN



J5-07186
STEVENS



J5-07187
Fig.1

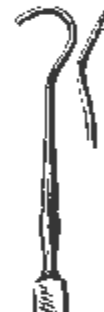

J5-07188
Fig.2



J5-07189
O'CONNOR



J5-07190
WIENER



J5-07191
WIENER



J5-07192
ROLLET

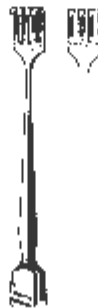

J5-07193
KNAPP



J5-07194



J5-07195
GRAEFE



J5-07196



J5-07197
BECKER



OPHTHALMOLOGY

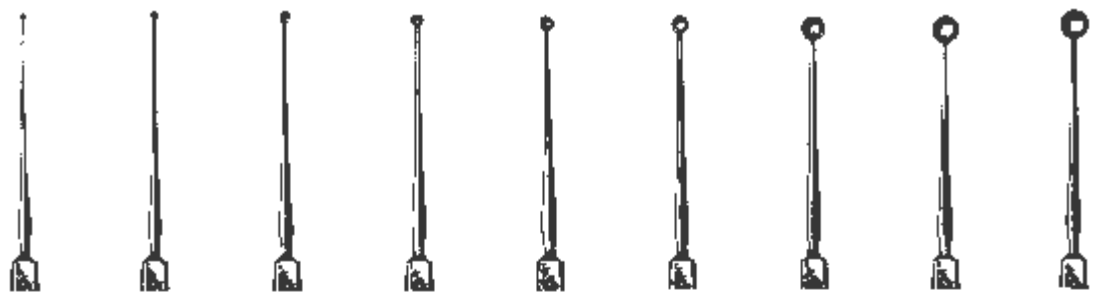

MEYHOEFER

- | | | | | | | | | |
|----------|----------|----------|----------|----------|----------|----------|----------|----------|
| J6-07198 | J6-07199 | J6-07200 | J6-07201 | J6-07202 | J6-07203 | J6-07204 | J6-07205 | J6-07206 |
| 0.5 Ømm | 1.0 Ømm | 1.5 Ømm | 1.8 Ømm | 2.0 Ømm | 2.5 Ømm | 3.5 Ømm | 4.0 Ømm | 4.5 Ømm |

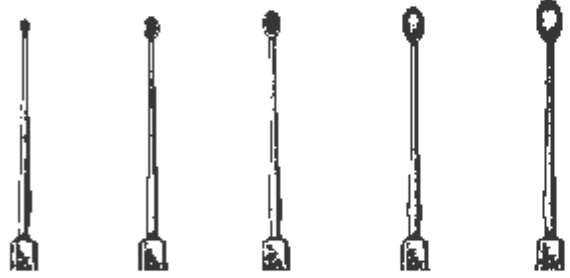

MEYHOEFER

- | | | | | |
|----------|----------|----------|----------|----------|
| J6-07207 | J6-07208 | J6-07209 | J6-07210 | J6-07211 |
| 1.0 Ømm | 2.0 Ømm | 2.5 Ømm | 3.0 Ømm | 3.5 Ømm |



J6-07212
 AXENFELD

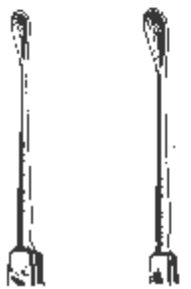

GRAEFE

- | | |
|----------|----------|
| J6-07213 | J6-07214 |
|----------|----------|

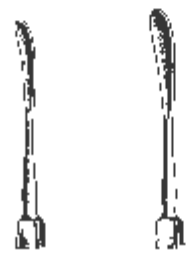

GRAEFE

- | | |
|----------|----------|
| J6-07215 | J6-07216 |
|----------|----------|



J6-07217
 KNAPP

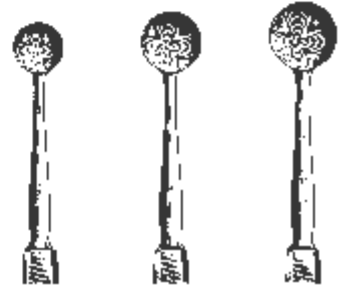

BUNGE

- | | | |
|----------|----------|----------|
| J6-07218 | J6-07219 | J6-07220 |
|----------|----------|----------|

INSTRUMENTS



OPHTHALMOLOGY



J7-07221
LANG

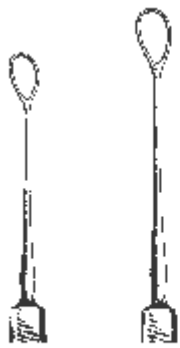

WEBER

J7-07222
Fig.1

J7-07223
Fig.2



J7-07224
SNELLEN



J7-07225
Fig.1



J7-07226
Fig.2



ARLT



J7-07227



J7-07228



J7-07229
WECKER



J7-07230

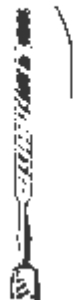

J7-07231
CULLER



J7-07232
WELLS



J7-07233
ARRUGA



J7-07234
WADSWORTH
TODD

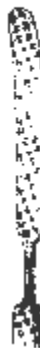

BANGERTER

J7-07235
6mm



J7-07236
10mm



J7-07237
12mm



J7-07238

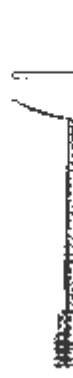

J7-07239
1.2 x 10mm



J7-07240
1.5 x 15mm



J7-07241
1.2 x 12mm



J7-07242
0.8 x 15mm

CASTROVIEJO



OPHTHALMOLOGY



J8-07243
 CASTROVIEJO



J8-07244
 WHEELER



J8-07245
 CASTROVIEJO
 0. mm, 0.75mm, 1.0mm

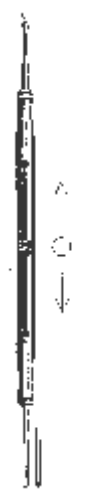

J8-07246
 DIX



J8-07247
 DIX



J8-07248
 DIX

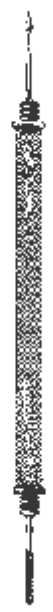

J8-07249
 DIX

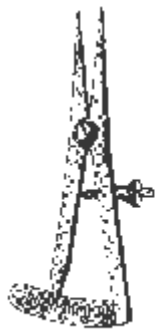

J8-07250
 CASTROVIEJO



J8-07251
 CONNIN-AMSLER



J8-07252
 DASTOOR
 60mm (2.1/2")



J8-07253
 HOLTH

INSTRUMENTS



OPHTHALMOLOGY

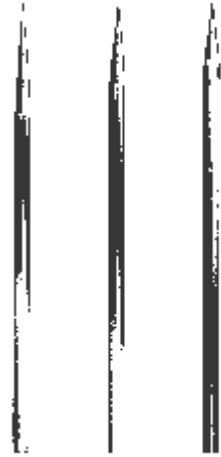

WILDER
J9-07254 J9-07255 J9-07256



J9-07257
ZIEGLER
Fig 1/2
Fig 3/4
Fig 5/6



J9-07258
CASTROVIEJO



J9-07259
GRAEFE
70mm/1mm, (2.3/4")



J9-07260
GRAEFE
70mm/1mm, (2.3/4")



J9-07261
GRAEFE
70mm/1mm, (2.3/4")



J9-07262
GRAEFE
70mm/1mm, (2.3/4")



IRIS FORCEPS



J10-07263
 GRAEFE
 70mm (2.3/4")
 100mm (4")



J10-07264
 GRAEFE
 70mm (2.3/4")
 100mm (4")



J10-07265
 GRAEFE
 70mm (2.3/4")
 100mm (4")



J10-07266
 GRAEFE
 70mm (2.3/4")
 100mm (4")

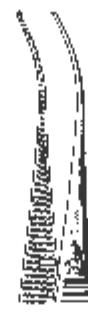

J10-07267
 GRAEFE
 70mm (2.3/4")
 100mm (4")



J10-07268
 GRAEFE
 70mm (2.3/4")
 100mm (4")



J10-07269
 STEVENS
 105mm (4.1/4")



J10-07270
 STEVENS
 105mm (4.1/4")



J10-07271
 STEVENS
 105mm (4.1/4")



J10-07272
 STEVENS
 105mm (4.1/4")



J10-07273
 STEVENS
 105mm (4.1/4")



J10-07274
 STEVENS
 105mm (4.1/4")

IRIS FORCEPS



J11-07275
 FOERSTER
 85mm (3.1/2")

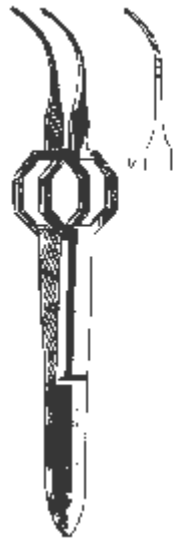

J11-07276
 FOERSTER
 85mm (3.1/2")

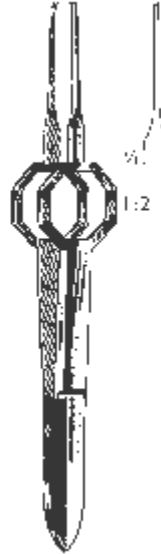

J11-07277
 FOERSTER
 85mm (3.1/2")

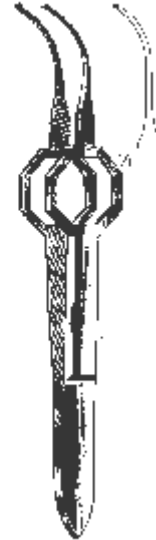

J11-07278
 FOERSTER
 85mm (3.1/2")



J11-07279
 HESS
 70mm (2.3/4")
 0.3mm



J11-07280
 HESS
 70mm (2.3/4")
 0.3mm



J11-07281
 GILL
 75mm (3")
 0.3mm



J11-07282
 GILL-HESS
 75mm (3")
 0.3mm



J11-07283
 GILL-HESS
 75mm (3")

OPHTHALMOLOGY

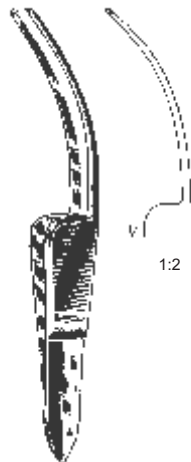

J12-07284
 FISCHER
 70mm (2.3/4")



J12-07285
 BARRAQUER-KATZIN
 70mm (2.3/4")
 0.4mm



J12-07286
 TROUTMAN (Colobri)
 70mm (2.3/4")
 0.12mm

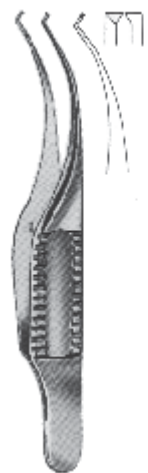

J12-07287
 BARRAQUER (Colobri)
 70mm (2.3/4")
 0.12mm

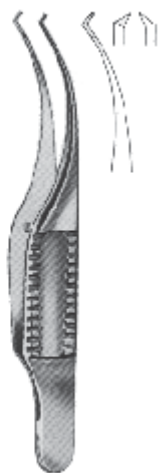

J12-07288
 BARRAQUER (Colobri)
 70mm (2.3/4")
 0.12mm



J12-07289
 KIRBY-ARTHUR
 90mm (3.3/4")
 0.2mm



J12-07290
 KIRBY-ARTHUR
 90mm (3.3/4")
 0.2mm



J12-07291
 McCULLOUGH
 95mm (3.3/4")



J12-07292
 McCULLOUGH
 95mm (3.3/4")

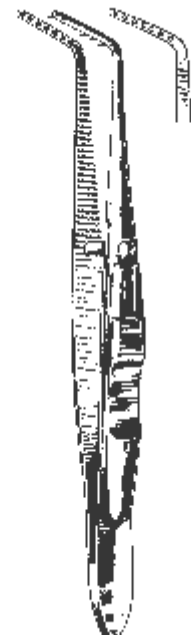

J12-07293
 JAMESON
 L, 100mm (4")

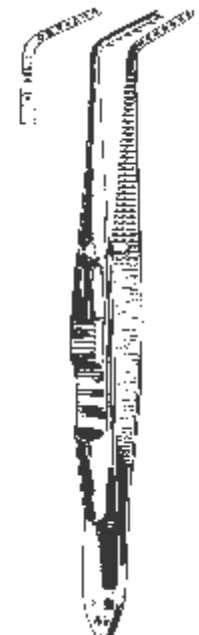

J12-07294
 JAMESON
 R, 100mm (4")

INSTRUMENTS



OPHTHALMOLOGY



J13-07295
BONACCOLTO
100mm (4")



J13-07296
BONACCOLTO
100mm (4")



J13-07297
BONACCOLTO
110mm (4.1/4")



J13-07298
DASTOOR
110mm (4.1/4")



J13-07299
DASTOOR
110mm (4.1/4")



J13-07300
BISHOP
85mm (3.1/2")
0.5mm



J13-07301
BISHOP
85mm (3.1/2")
0.8mm



J13-07302
BISHOP
85mm (3.1/2")
0.5mm



J13-07303
BISHOP
85mm (3.1/2")
0.8mm



J13-07304
Mod. BONN
70mm (2.3/4")
0.12mm



J13-07305
Mod. BONN
70mm (2.3/4")
0.12mm



OPHTHALMOLOGY



J14-07306
 Mod. BONN
 100mm (4"), 0.12mm



J14-07307
 Mod. TUBINGEN
 100mm (4")

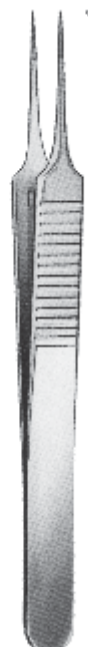

J14-07308
 Mod. BONN
 100mm (4"), 0.12mm



J14-07309
 Mod. TUBINGEN
 100mm



J14-07310
 PRINCE
 100mm (4")



J14-07311
 PRINCE
 100mm (4")

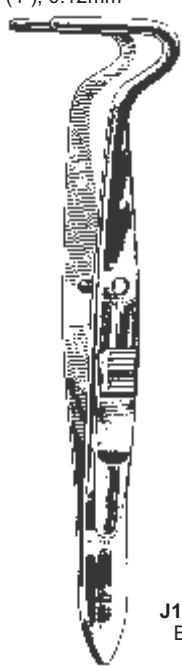

J14-07312
 BERKE



J14-07312



J14-07313



J14-07314
 TROUTMAN
 85mm (3.1/2")
 0.8mm



J14-07315
 BARRAQUER
 55mm (2.1/4")

7mm



OPHTHALMOLOGY



J15-07316
 ELSCHING
 110mm (5-1/4")



J15-07317
 GRAEFE



J15-07318
 LESTER



J15-07319
 CASTROVIEJO



J15-07320
 CASTROVIEJO



J15-07321
 CASTROVIEJO

2:2



J15-07322
 CASTROVIEJO

2:2

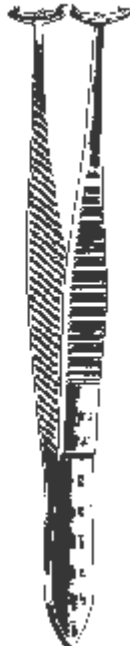

J15-07323
 BARRAQUER
 100mm (4")

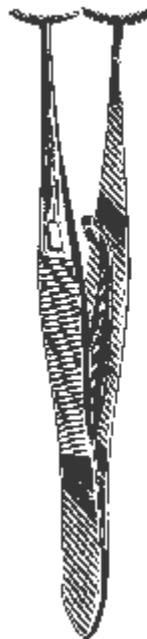

J15-07324
 GREEN
 100mm (4")

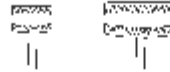

J15-07325 **J15-07326**
 5mm 10mm

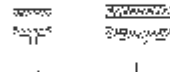

J15-07327 **J15-07328**
 5mm 10mm



J15-07329
 GILL ARRUGA
 75mm (3")



CAPSULAR FORCEPS



J16-07330
 TERSON
 90mm (3.3/4")



J16-07331
 KALT
 100mm (4")



J16-07332
 ELSCHING
 100mm (4")



J16-07333
 ARRUGA
 100mm (4")



J16-07334
 ARRUGA
 100mm (4")



J16-07335
 CASTROVIEJO
 100mm (4")



J16-07336
 SCHWEIGGER
 100mm (4")



J16-07337
 SCHWEIGGER
 100mm (4")



J16-07338
 ELSCHNIG
 100mm (4")



J16-07339
 HESS
 60mm (2.1/2")



J16-07340
 HESS
 65mm (2.1/2")



J16-07341
 FUCHS
 70mm (2.3/4")



OPHTHALMOLOGY

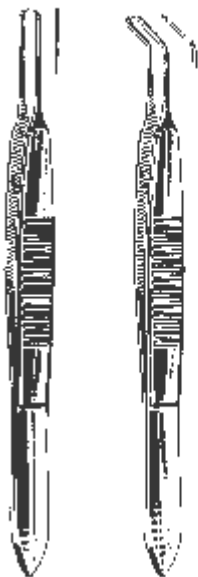

J17-07342
CASTROVIEJO
0.12mm, 0.30mm, 0.5mm, 1.00mm, 1.5mm



J17-07343
MOORFIELD
100mm (4")



J17-07344
St. MARTIN
70mm (2.3/4")



J17-07345
Mod. TUBINGEN
100mm (4")



J17-07346
PAUFIQUE
85mm (3.1/2")



J17-07347
PAUFIQUE
85mm (3.1/2")



J17-07348
McPHERSON
100mm (4")



J17-07349
McPHERSON
100mm (4")



OPHTHALMOLOGY



J18-07350
 AYER
 90mm (3.3/4")



J18-07351
 AYER
 90mm (3.3/4")



J18-07352
 LAMBERT
 90mm (3.3/4")

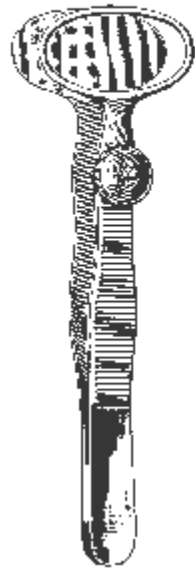

J18-07353
 DESMARRES
 90mm (3.3/4")

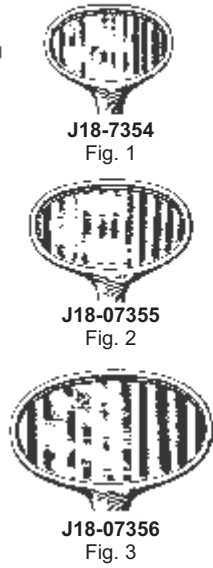

J18-7354
 Fig. 1

J18-07355
 Fig. 2

J18-07356
 Fig. 3

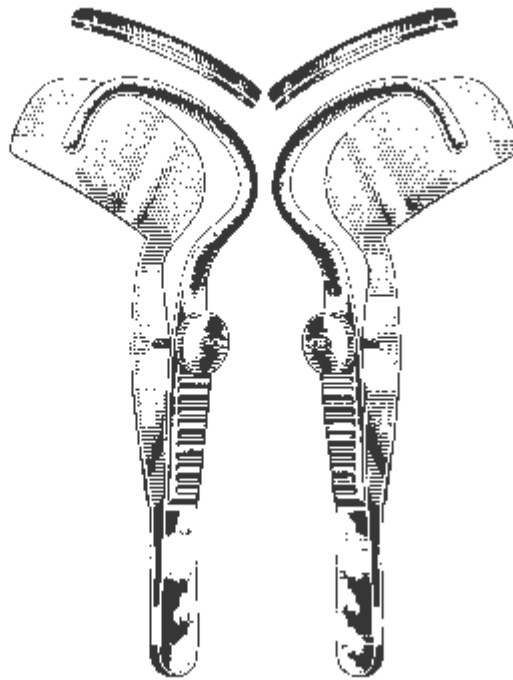

J18-07357
 SNELLEN
 100mm (4")

J18-07358
 SNELLEN
 100mm (4")

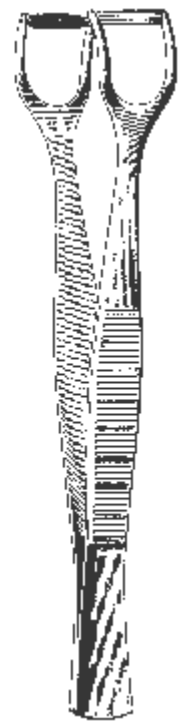

J18-07359
 KNAPP-LUER
 110mm (4.1/4")

INSTRUMENTS



PROBES

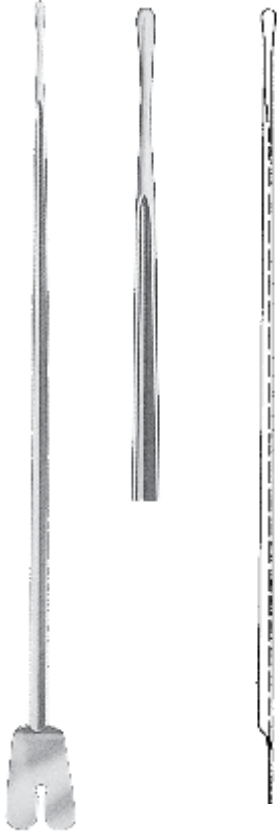

BRODIE

K1-07500
200mm (8")
Ball point

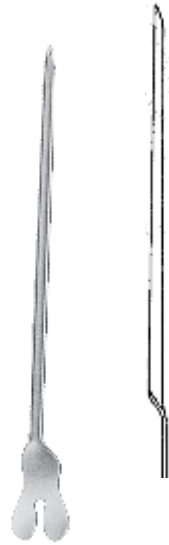

DIRECTORS

K1-07501
130mm (5.1/8")

K1-07502
145mm (5.3/4")

K1-07503
160mm (6.1/4")



K1-07504
140mm (5.1/2")



PROBES



SINUS
K2-07505
 150mm (6")



PROBE
 With Eye

PROBE

K2-07506
 127mm (5")

K2-07507
 152mm (6")

K2-07508
 178mm (7")

K2-07509
 200mm (8")

K2-07510
 255mm (10")

K2-07511
 305mm (12")



MYRTLE LEAF PROBE
K2-07512
 145mm (5.3/4")



1mm Tip
K2-07513
 145mm (5.3/4")

1.5mm tip

K2-07514
 130mm (5.1/8")

K2-07515
 145mm (5.3/4")

K2-07516
 160mm (6.1/4")

K2-07517
 180mm (7")

K2-07518
 200mm (8")

K2-07519
 250mm (10")

2mm tip

K2-07520
 145mm (5.3/4")

K2-07521
 160mm (6.1/4")

K2-07522
 180mm (7")

K2-07523
 200mm (8")



PROBES



LIEBRICH LACHRYMAL

K3-07528

No. 00 - 0 (0.7 - 0.8mm)

K3-07529

No. 1 - 2 (0.9 - 1.1mm)

K3-07530

No. 3 - 4 (1.3 - 1.4mm)

K3-07531

No. 5 - 6 (1.5 - 1.6mm)



ANEL LACHRYMAL

K3-07532

108mm (4.1/4") 0.6mm , small



JOBSON HORNE

K3-07534

140mm (5.1/2")

K3-07535

178mm (7")



CAWTHORNE

K3-07533

140mm (5.1/2")



PROBES



**KINGS COLLEGE HOSPITAL
 COCAINISING WIRE**

K4-07536
 89mm (3.1/2")

K4-07537
 133mm (5.1/4")



LOGAN TURNER

K4-07538
 120mm (4.3/4")
 1.00mm diameter



FISTULA PROBE

K4-07539
 240mm (9.1/2")



DISSECTORS

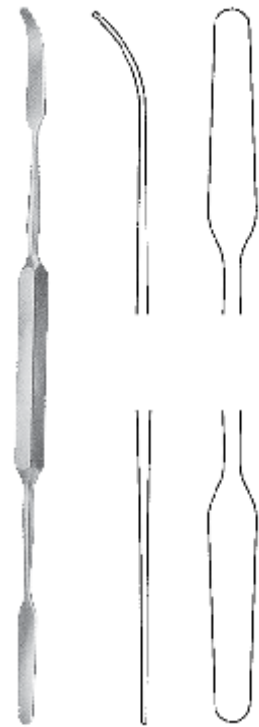

MACDONALD
K5-07600
 185mm (7.1/4")
 Double ended



WATSON CHEYNE
 Fine with probe
K5-07601
 125mm (5")
K5-07602
 190mm (7.1/2")

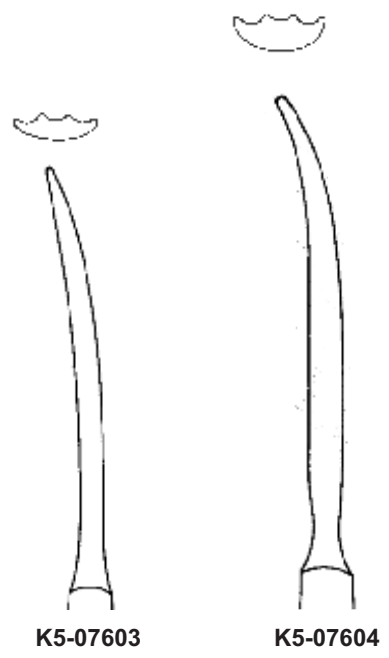

K5-07603 **K5-07604**



KOCHER THYROID
K5-07603
 150mm(6")
K5-07604
 170mm (6.3/4")

DISSECTORS

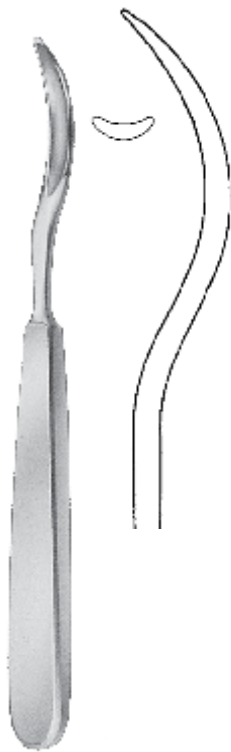

KOCHER THYROID

K6-07605
190mm (7.1/2")

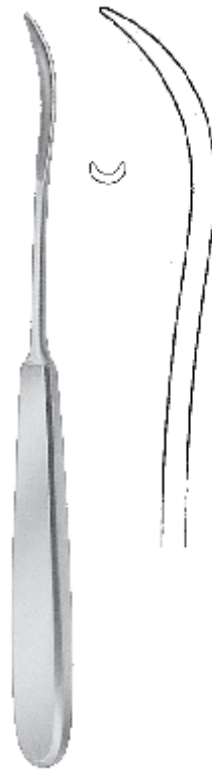

KING

K6-07606
195mm (7.3/4")

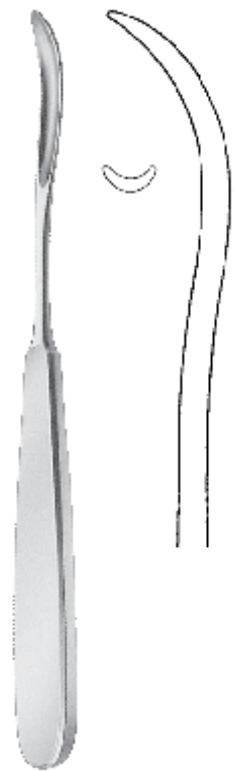

KING

K6-07607
200mm (8")



DISSECTORS

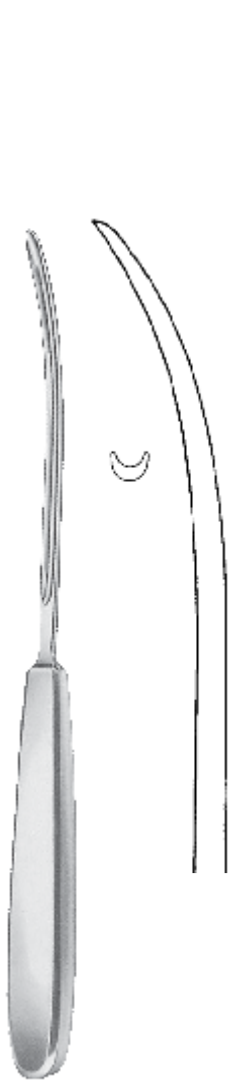

PAYR
K7-07608
225mm (9")

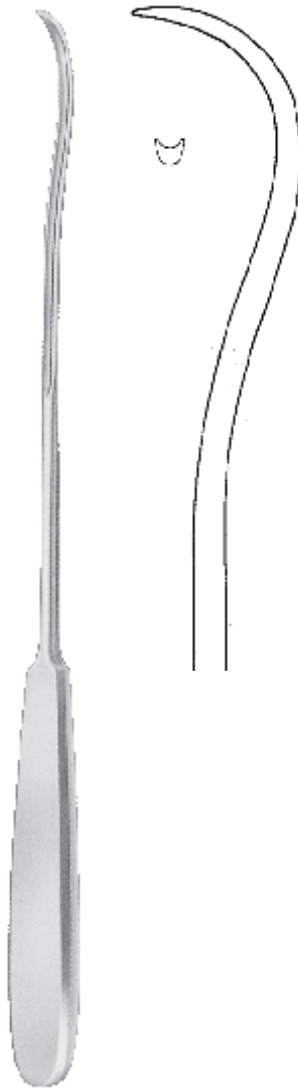

PAYR
K7-07609
280mm (11")



GWYNNE EVANS TONSIL
200mm (8")
Double ended

K7-07610
6mm wide

K7-07611
8mm wide



RETRACTOR



**HURD PILLAR RETRACTOR
AND TONSIL**

K8-07612
197mm
Double ended

**MOLLINSON ANTERIOR
PILLAR RETRACTOR AND
TONSIL DISSECTOR**

K8-07613
210mm (8.1/4")
Double ended

SYME TONSIL

K8-07614
180mm (7")
Double ended, one blunt
one semi - sharp



SUTURE INSTRUMENTS



MICHEL

K9-07700
 125mm (5")
 Applying forceps



MICHEL

K9-07701
 125mm (5")
 Applying and extracting forceps



MICHEL

K9-07702
 135mm (5.1/4")
 Extracting forceps

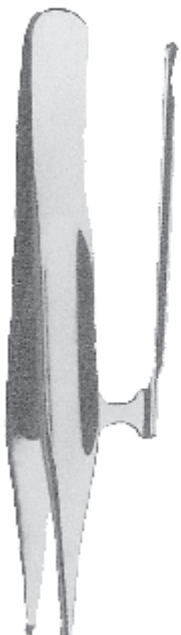

BONNEY

K9-07703
 150mm (6")
 Upward rack

K9-07704
 150mm (6")
 Downward rack

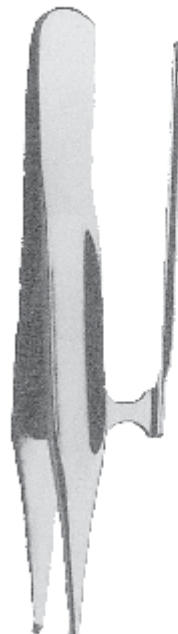

CHILDES

K9-07705
 180mm (7")
 Upward rack

K9-07706
 180mm (7")
 Upward rack
 fenestrated

K9-07707
 180mm (7")
 Downward rack

SUTURE INSTRUMENTS

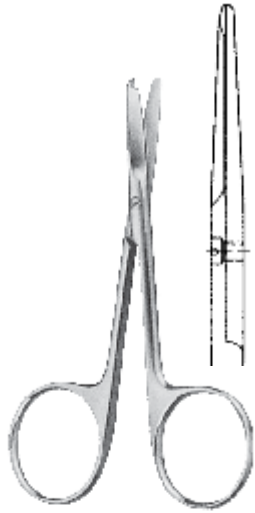

LITTAUER

K10-07708
 110mm (4.1/2")
 With hook end



LITTAUER (SPENCER)

K10-07709
 80mm (3.1/2")
 With hook end



**CHARNLEY
 SUTURE
 FORCEPS**



K10-07713
 180mm (7")

K10-07714
 125mm (5")



MILLIN "BOOMERANG"

K10-07710
 230mm (9")
 With two needles

MILLIN NEEDLE

K10-07711
 Small

K10-07712
 Large



K10-07711



K10-07712



MICHEL CLIPS

K10-07715
 12mm
 Single, Small
 Pack of 100

K10-07716
 14mm
 Single, medium
 pack of 100

K10-07717
 16mm
 Single, large
 Pack of 100



K10-07718
 12mm
 Double teeth
 Pack of 100

ANEURYSM NEEDLES

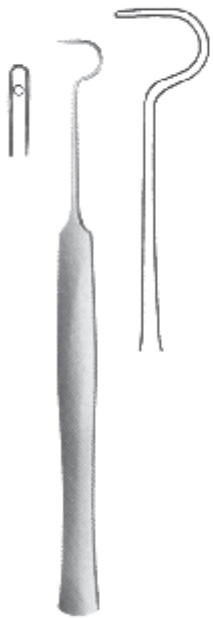

**SMALL ANEURYSM
 NEEDLE**

K11-07719
 150mm (6")

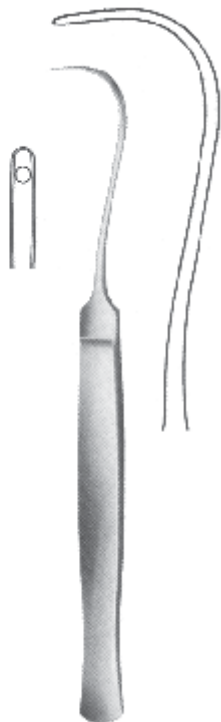

SYME

K11-07720
 170mm (6.3/4")



DESCHAMPS

K11-07721
 215mm (8.1/2")
 For right hand, blunt



DESCHAMPS

K11-07722
 215mm (8.1/2")
 For left hand, blunt

ANEURYSM NEEDLES



DESCHAMPS
K12-07723
 210mm (8.1/4")
 For right hand, blunt



DESCHAMPS
K12-07724
 210mm (8.1/4")
 For left hand, blunt

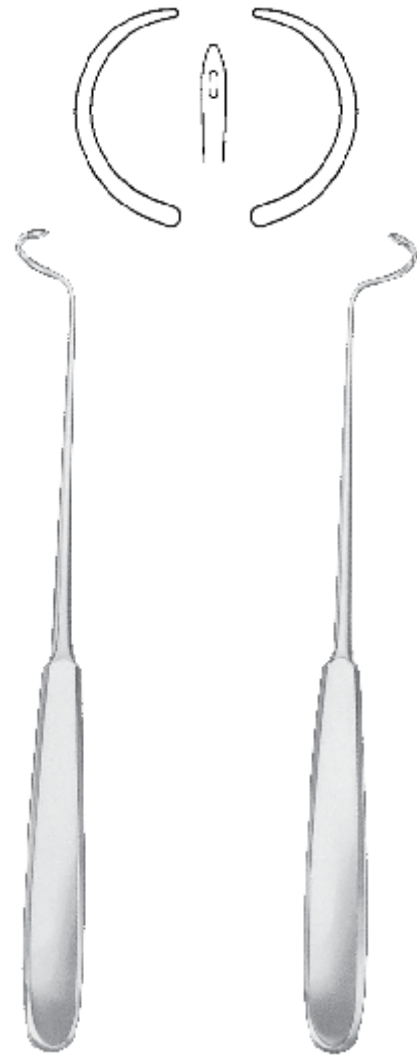

DESCHAMPS
K12-07725
 215mm (8.1/2")
 For right hand, blunt

DESCHAMPS
K12-07726
 215mm (8.1/2")
 For left hand, blunt



ANEURYSM NEEDLES



DESCHAMPS

K13-07727
230mm (9")
Malleable



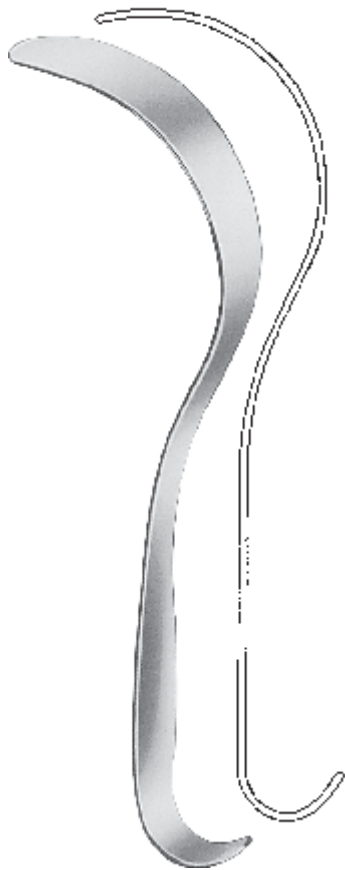

DEAVER

L1-07800
215mm (8.1/2")
Blade: 22mm wide



DEAVER

L1-07801
235mm (9.1/4")
Blade: 25mm wide



HAND HELD RETRACTORS

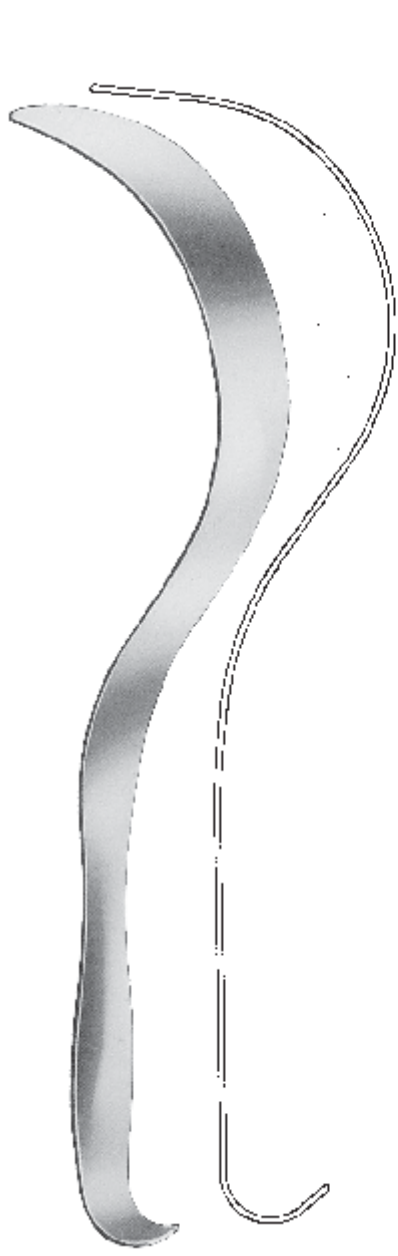

DEAVER
L2-07802
300mm (12")
Blade: 25mm wide

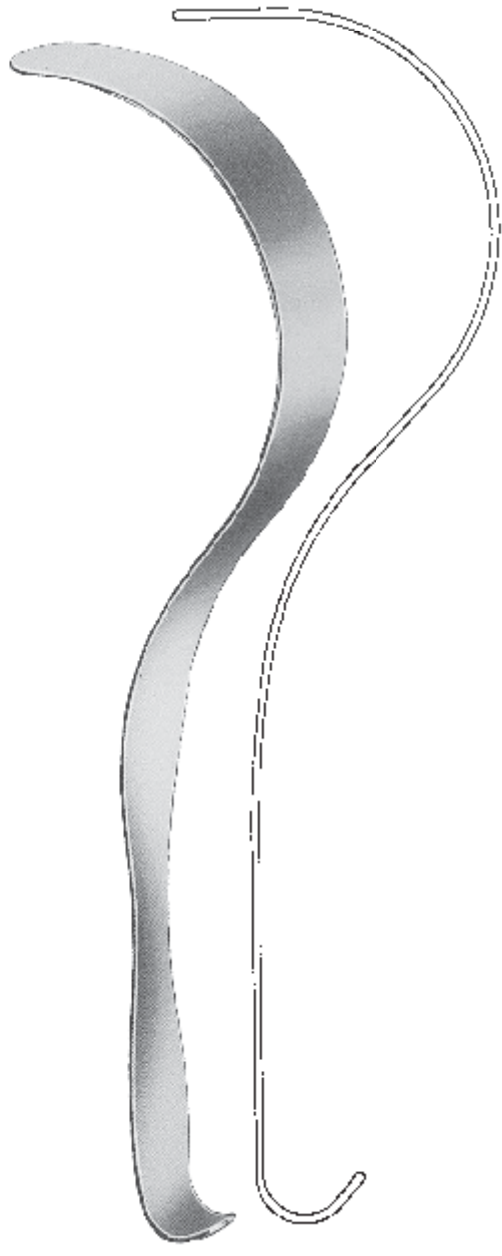

DEAVER
L2-07803
315mm (12.1/2")
Blade: 25mm wide



DEAVER

L3-07805
300mm (12")
Blade: 38mm wide

DEAVER

L3-07806
310mm (12.1/4")
Blade: 50mm wide

DEAVER

L3-07807
320mm (12.3/4")
Blade: 75mm wide



HAND HELD RETRACTORS



DEAVER GRIP

No 1
L4-07808
310mm (12.1/4")
Blade: 25mm wide



DEAVER GRIP

No 2
L4-07809
310mm (12.1/4")
Blade: 38mm wide





DEAVER GRIP

No 3
L5-07810
302mm (12")
Blade: 50mm wide



DEAVER GRIP

No 4
L5-07811
310mm (12.1/4")
Blade: 75mm wide

HAND HELD RETRACTORS



RICHARDSON
 240mm (9.1/2")

L6-07812
 Blade: 23mm x 20mm



L6-07813
 Blade: 30mm x 29mm



L6-07814
 Blade: 37mm x 37mm



L6-07815
 Blade: 47mm x 21mm



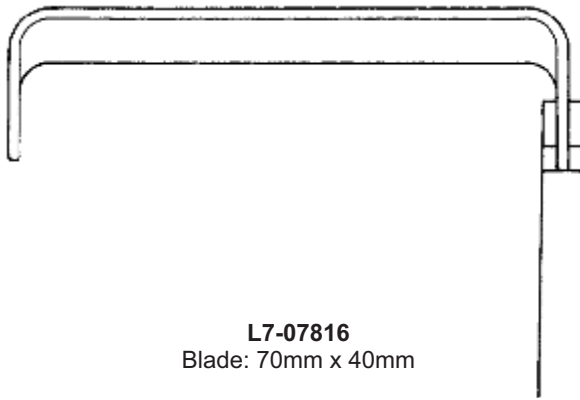

L7-07816
 Blade: 70mm x 40mm

L7-07817
 Blade: 70mm x 50mm

L7-07818
 Blade: 70mm x 65mm



MORRIS
 245mm (9.3/4")
 Single blade



HAND HELD RETRACTORS

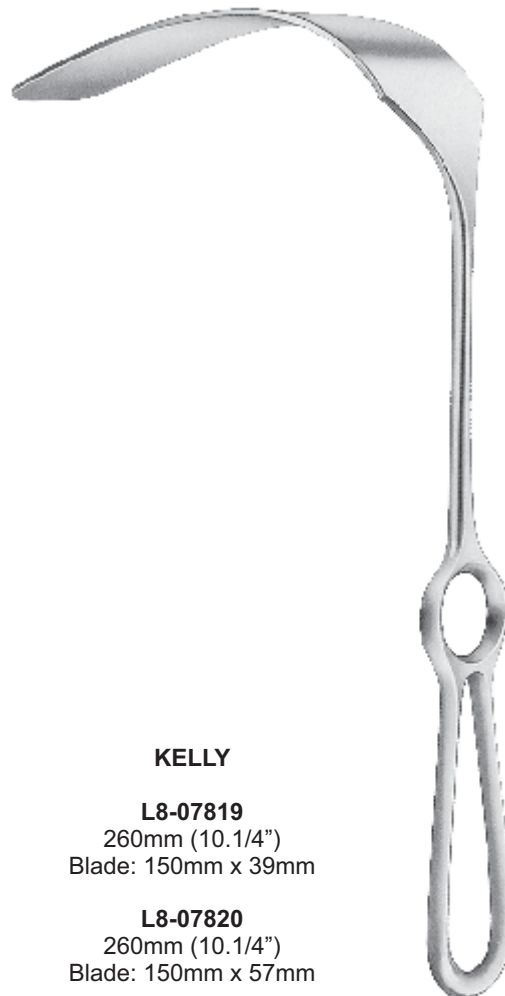
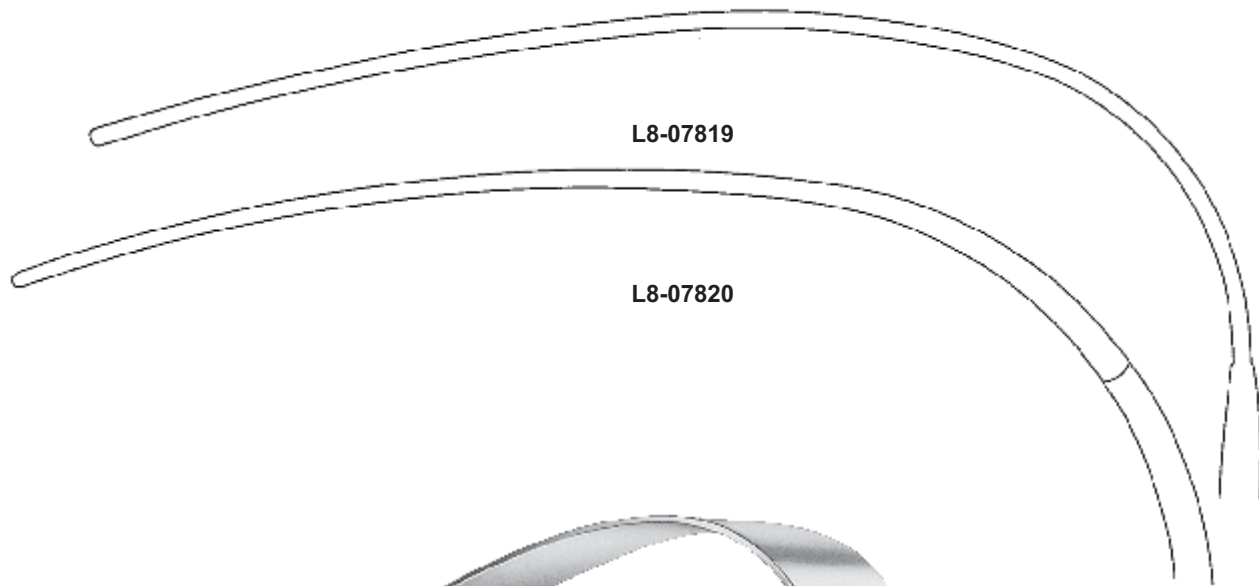

KELLY

L8-07819
260mm (10.1/4")
Blade: 150mm x 39mm

L8-07820
260mm (10.1/4")
Blade: 150mm x 57mm



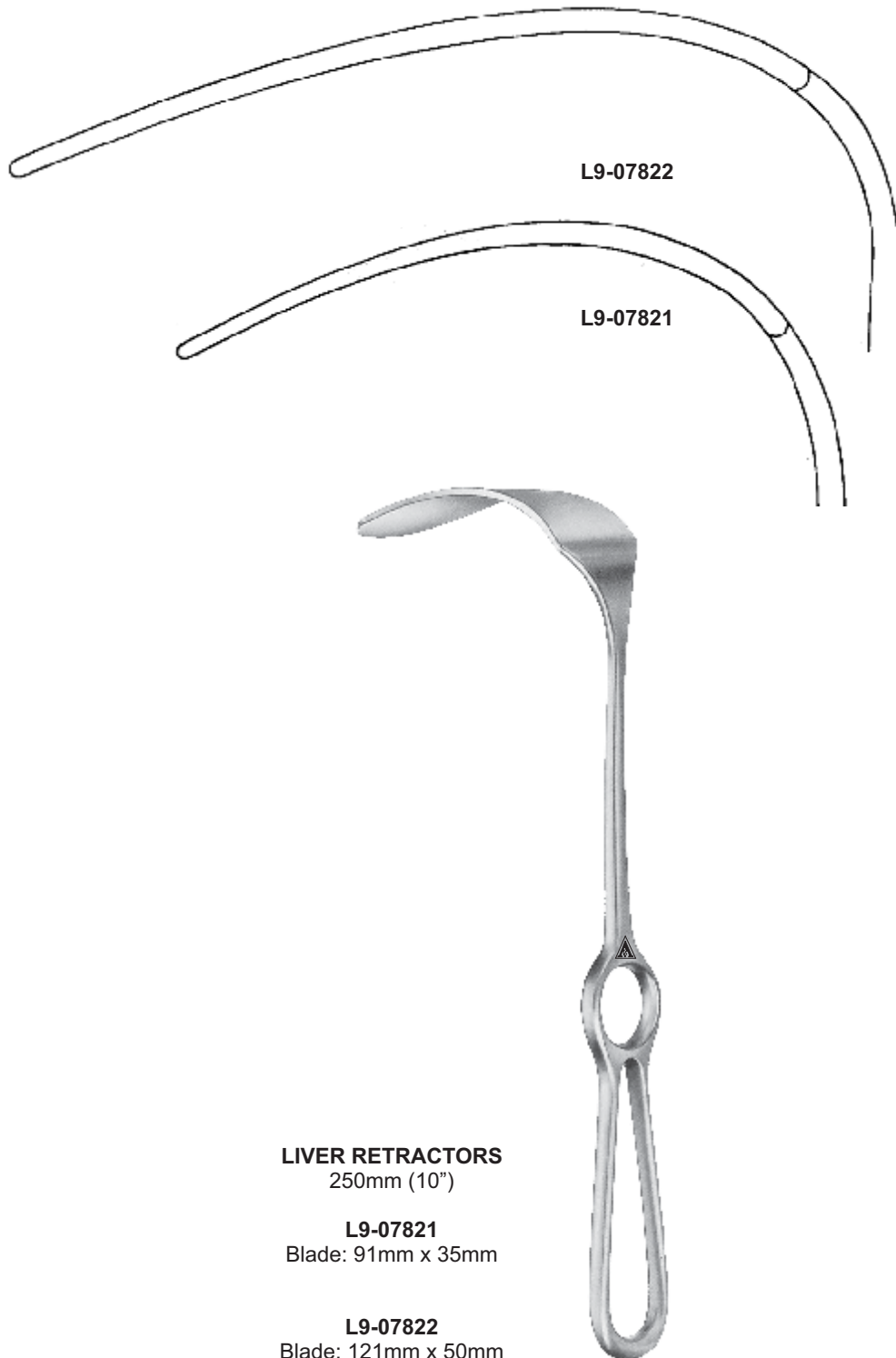

LIVER RETRACTORS
250mm (10")

L9-07821
Blade: 91mm x 35mm

L9-07822
Blade: 121mm x 50mm

HAND HELD RETRACTORS



MIDDELDORPF



L10-07823
 220mm (8.3/4")
 Blade: 15mm x 15mm

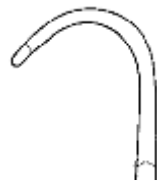

L10-07824
 215mm (8.1/2")
 Blade: 20mm x 22mm

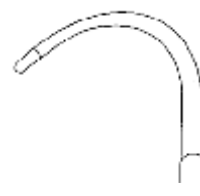

L10-07825
 235mm (9.1/4")
 Blade: 28mm x 28mm

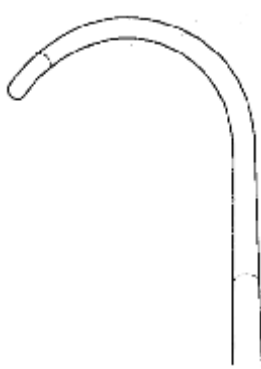

DURHAM
 215mm (8.1/2")

L10-07826
 Blade: 10mm

L10-07827
 Blade: 16mm



MOYNIHAN
205mm (8")

L11-07828
Blade: 20mm x 15mm

L11-07829
Blade: 20mm x 12mm



L11-07828



L11-07829



KOCHER

L11-07830
230mm (9")
Blade: 36mm x 20mm

HAND HELD RETRACTORS

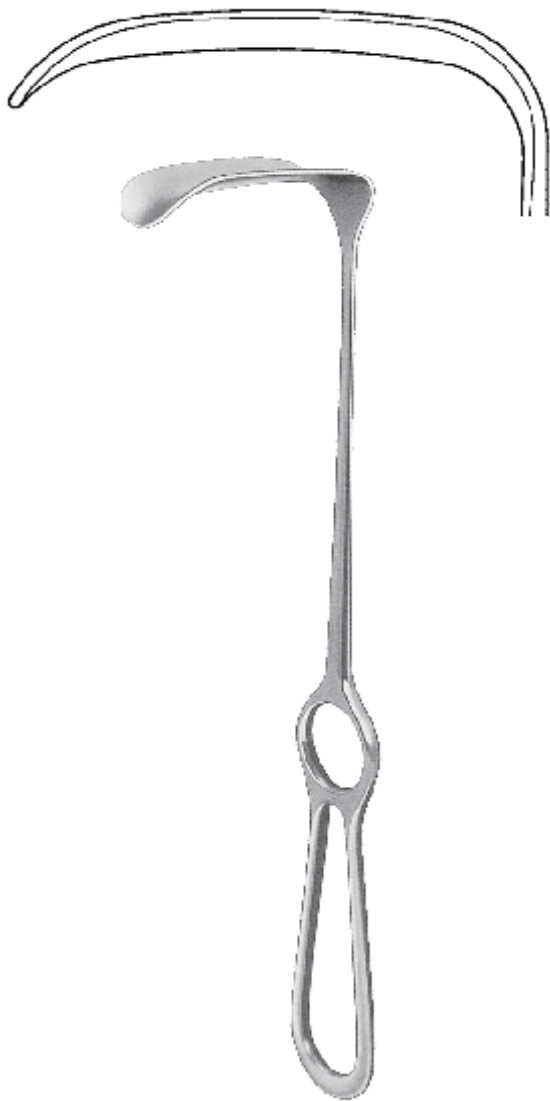

KOCHER
L12-07831
 250mm (10")
 Blade: 67mm x 25mm



CUSHINGS VEIN RETRACTORS
 250mm (10")



L12-07832
 Blade: 14mm x 11mm



L12-07833
 Blade: 18mm x 13mm



L12-07834
 Blade: 22mm x 15mm

HAND HELD RETRACTORS

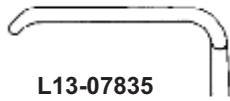

L13-07835
 Blade: 25mm x 6mm

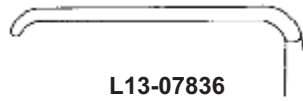

L13-07836
 Blade: 35mm x 8mm

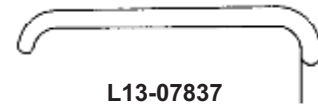

L13-07837
 Blade: 35mm x 11mm

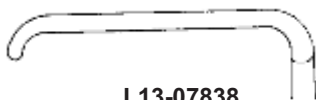

L13-07838
 Blade: 35mm x 15mm

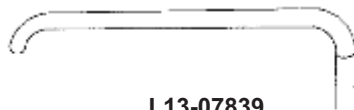

L13-07839
 Blade: 41mm x 11mm

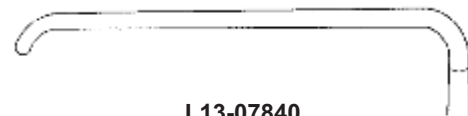

L13-07840
 Blade: 55mm x 11mm



LANGENBECK
 215mm (8.1/2")

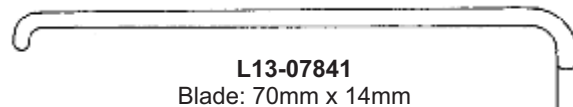

L13-07841
 Blade: 70mm x 14mm

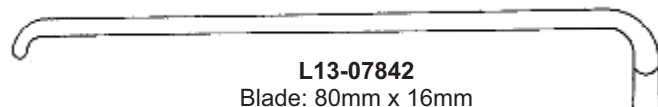

L13-07842
 Blade: 80mm x 16mm

HAND HELD RETRACTORS

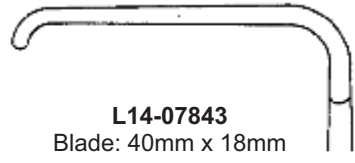

L14-07843
 Blade: 40mm x 18mm

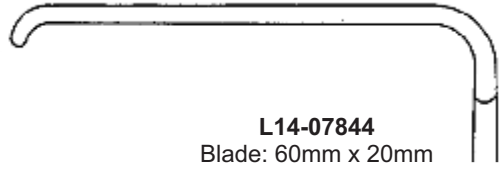

L14-07844
 Blade: 60mm x 20mm

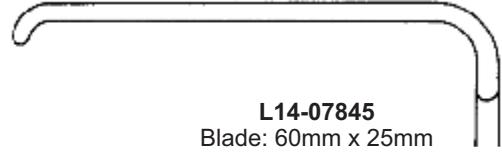

L14-07845
 Blade: 60mm x 25mm

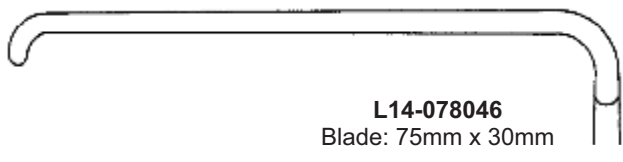

L14-078046
 Blade: 75mm x 30mm

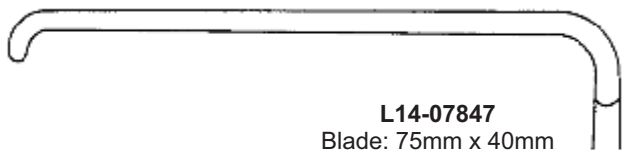

L14-07847
 Blade: 75mm x 40mm



KOCHER
 230mm (9")

HAND HELD RETRACTORS



FARABEUF
 125mm (5")

L15-07848

Set consisting of
 Inner blade: 22mm x 10mm
 28mm x 12mm
 Outer blade: 25mm x 10mm
 32mm x 12mm



FARABEUF
 150mm (6")

L15-07849

Set consisting of
 Inner blade: 20mm x 16mm
 24mm x 16mm
 Outer blade: 23mm x 16mm
 28mm x 16mm



WALTON

305mm (12")
 Malleable

L15-07850
 13mm wide

L15-07851
 25mm wide

L15-07852
 38mm wide

L15-07853
 51mm wide

HAND HELD RETRACTORS



L16-07854



L16-07855



L16-07858



L16-07859



165mm (6.1/2")
 Small curve sharp



165mm (6.1/2")
 Small curve blunt



L16-07856



L16-07857



L16-07860



L16-07861



165mm (6.1/2")
 Large curve sharp



165mm (6.1/2")
 Large curve blunt



L16-07862



L16-07863



L16-07866



L16-07867



L16-07864



L16-07865



L16-07868



L16-07869

HAND HELD RETRACTORS



L17-07870
 Blade: 9mm x 8mm
 Sharp



L17-07871
 Blade: 8mm x 8mm
 Blunt



L17-07872
 Blade: 9mm x 19mm
 Sharp



L17-07873
 Blade: 8mm x 19mm
 Blunt



L17-07874
 Blade: 9mm x 29mm
 Sharp



L17-07875
 Blade: 8mm x 29mm
 Blunt



L17-07876
 Blade: 9mm x 13mm
 Sharp



L17-07877
 Blade: 8mm x 13mm
 Blunt



VOLKMANN
 220mm (8")



HAND HELD RETRACTORS



L18-07879



L18-07881



LEMPERT
225mm (9")

L18-07878
Blade 9mm x 19mm
Sharp

L18-07879
Blade 8.5mm x 19mm
Blunt



BALLANCE
225mm (9")

L18-07880
Blade 9mm x 29mm
Sharp

L18-07881
Blade 8.5mm x 29mm
Blunt

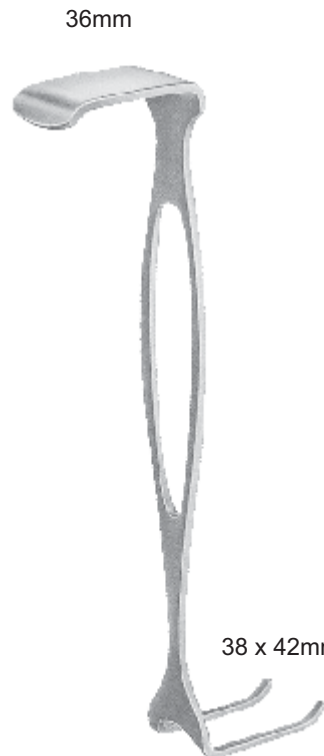

CZERNY

L18-07883
175mm (7")



HAND HELD RETRACTORS



ISRAEL
 255mm (10")

L19-07883
 Blade: 39mm x 40mm
 Blunt

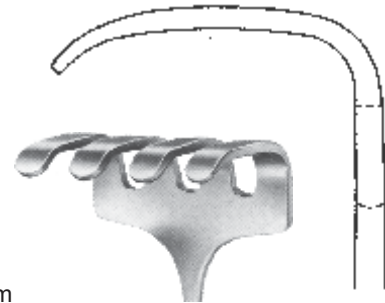

L19-07884
 Blade: 47mm x 51mm
 Blunt

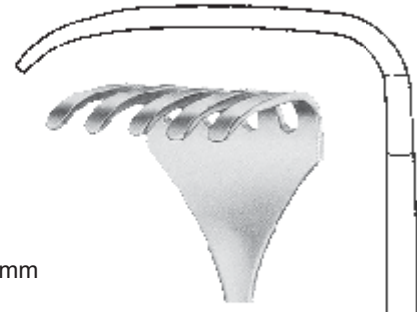

L19-07885
 Blade: 53mm x 62mm
 Blunt

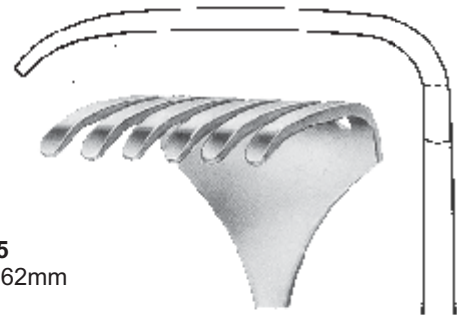

L19-07886
 Blade: 70mm x 70mm
 Blunt

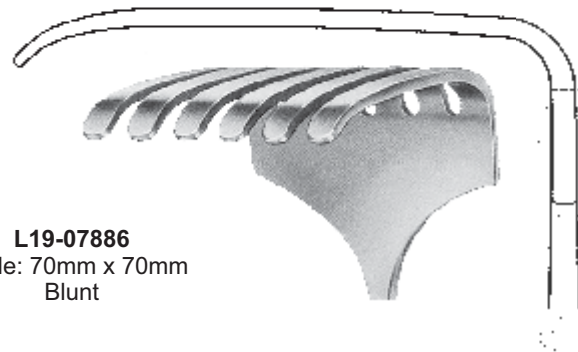

HAND HELD RETRACTORS



L20-07888

L20-07887

MEYERDING
 180mm (7")

L20-07887
 Blade: 5mm x 10mm
 Sharp

L20-07888
 Blade: 7mm x 18mm



LAGENBECK-GREEN

L20-07889
 160mm (6.1/4")
 Blade: 16mm x 6mm



CANNY RYAL

L20-07890
 190mm (7.1/2")
 Blade: 16mm

L20-07891
 190mm (7.1/2")
 Blade: 20mm

L20-07892
 200mm (8")
 Blade: 25mm

HAND HELD RETRACTORS

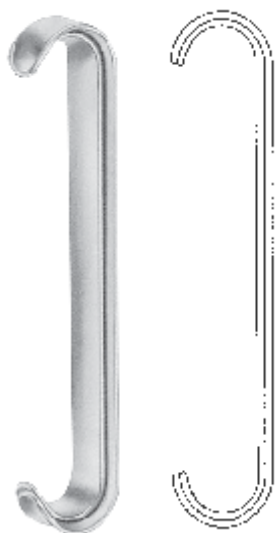

PARKER

L21-07893

135mm (5.3/4")

Inner blade: 18mm x 15mm

Outer blade: 22mm x 15mm

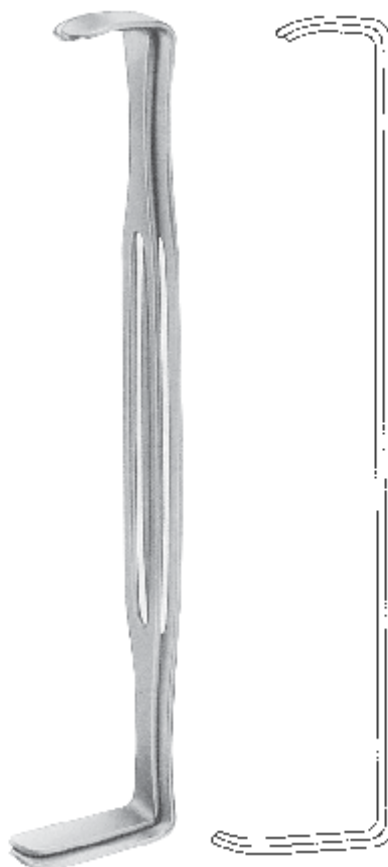

US ARMY

L21-07894

220mm (8.3/4")

Inner blade: 22mm x 15mm

39mm x 15mm

Outer blade: 26mm x 15mm

43mm x 15mm



ROUX

165mm (6.1/2")

L21-07895

Set of three consisting of:

L21-07896

Blades: 19mm x 22mm

23mm x 30mm

L21-07897

Blades: 25mm x 26mm

28mm x 38mm

L21-07898

Blades: 28mm x 29mm

33mm x 45mm



HAND HELD RETRACTORS

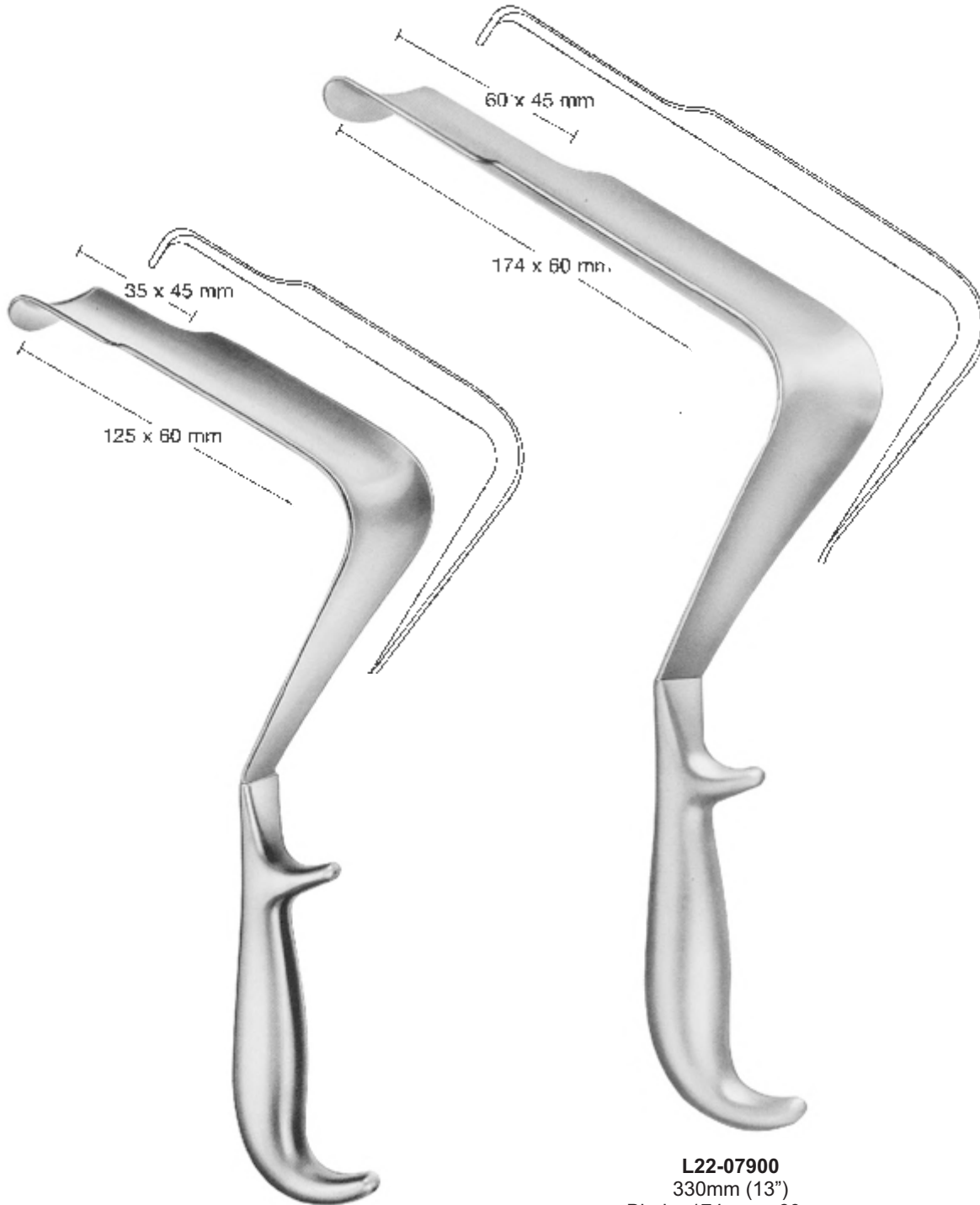

LLOYD DAVIS

L22-07899
290mm (11.1/2")
Blade: 125mm x 60mm
End: 35mm x 45mm

L22-07900
330mm (13")
Blade: 174mm x 60mm
End: 60mm x 45mm



HAND HELD RETRACTORS



SIMON

L23-07901
220mm (8.3/4")



DOYEN

L23-07902
250mm (10")
Blade: 53mm x 80mm



RETRACTOR

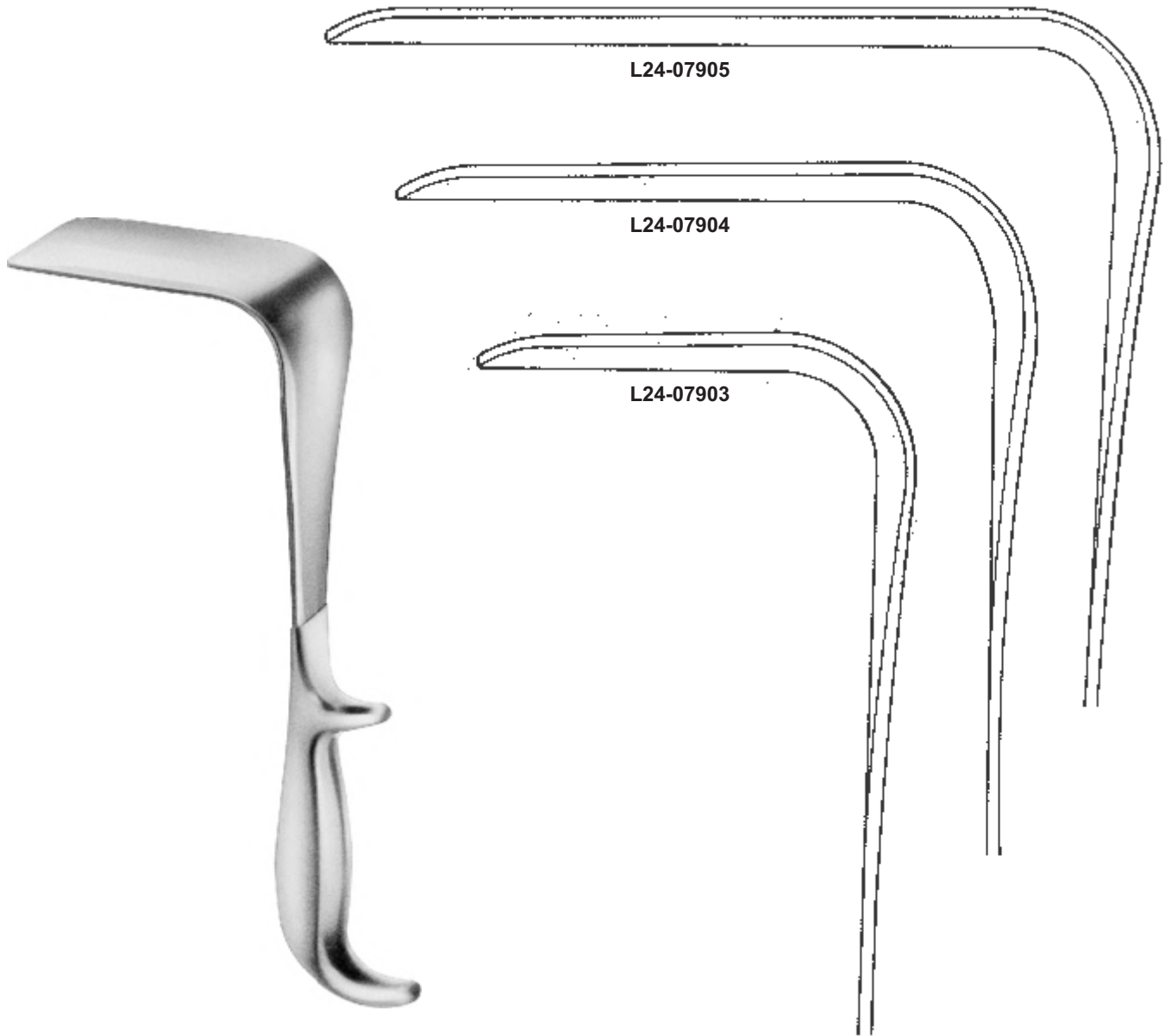

DOYEN
240mm (9.1/2")

L24-07903
Blade: 60mm x 45mm

L24-07904
Blade: 90mm x 45mm

L24-07905
Blade: 120mm x 45mm



HAND HELD RETRACTORS



ABDOMINAL RETRACTOR
 240mm (9.1/2")

L25-07906
 Blade: 34mm x 50mm

L25-07907
 Blade: 46mm x 75mm

L25-07908
 Blade: 64mm x 85mm

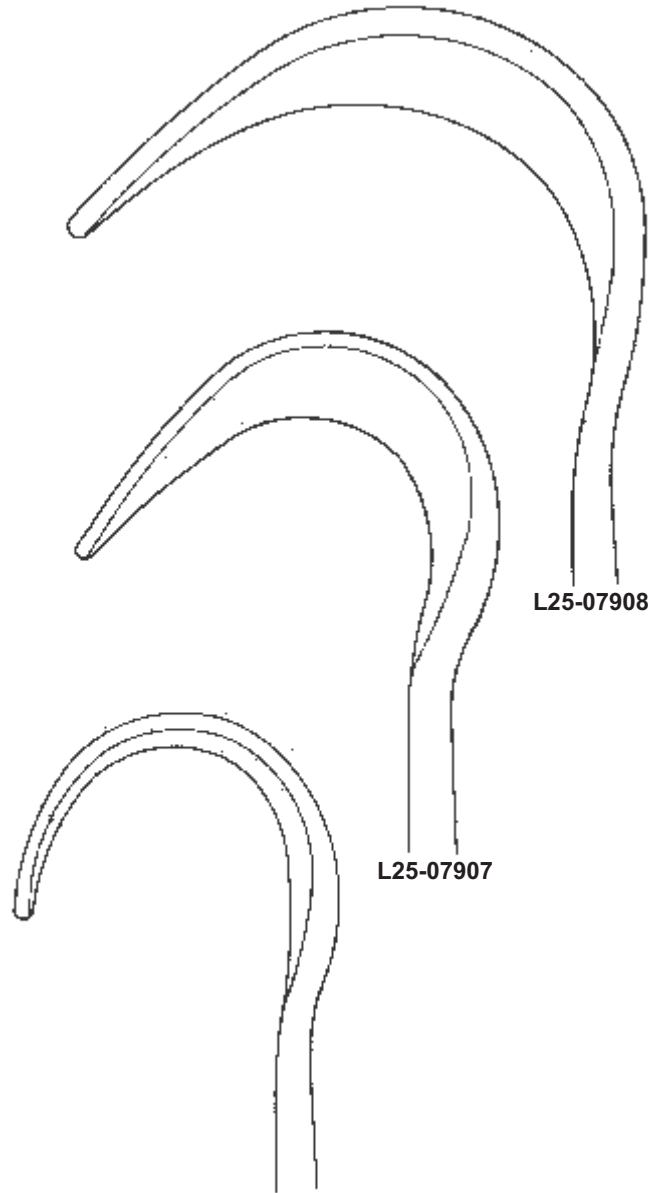

L25-07906

L25-07907

L25-07908

HAND HELD RETRACTORS



WERTHEIM
L26-07909
 300mm (12")
 Blade: 100mm x 40mm

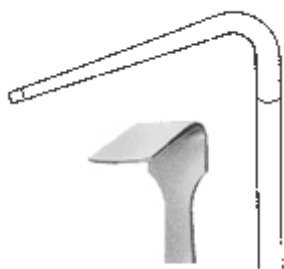

L26-07912
 Blade: 32mm x 19mm

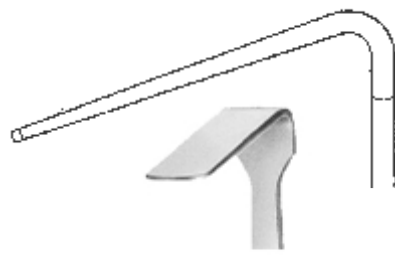

L26-07913
 Blade: 41mm x 19mm

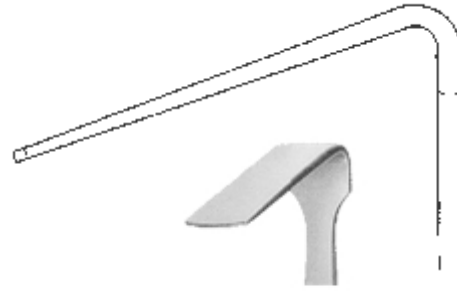

L26-07914
 Blade: 57mm x 19mm

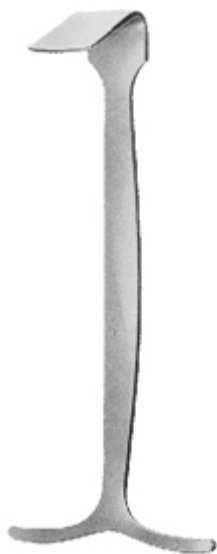

SMILLIE RETRACTORS

L26-07910
 145mm (5.3/4")

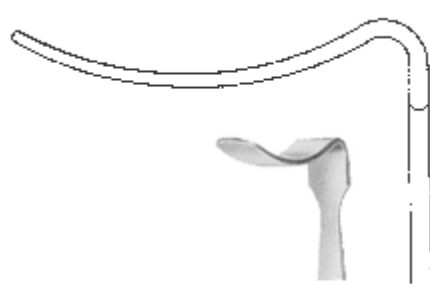

L26-07915
 Blade: 10mm

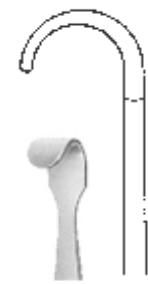

L26-07911

HAND HELD RETRACTORS



**LANGENBECK
BONE HOOK**

L27-07916
 205mm (8")
 Sharp



**LANGENBECK
BONE HOOK**

L27-07917
 205mm (8")
 Blunt



**KOCHER
BONE HOOK**

L27-07918
 220mm (8.3/4")
 Sharp



**KOCHER
BONE HOOK**

L27-07919
 220mm (8.3/4")
 Blunt



RETRACTOR



RETRACTOR
 155mm (6")
 Flexible shaft



L28-07920
 2 prong, sharp



L28-07921
 2 prong, blunt



L28-07922
 3 prong, sharp



L28-07923
 3 prong, blunt



L28-07925
 4 prong, sharp



L28-07924
 4 prong, blunt



RETRACTOR



L28-07926
 125mm (5")



L28-07927
 135mm (5.1/4")



L28-07928
 130mm (5.1/8")



KILNER
 150mm (6")

L28-07929
 Sharp

L28-07930
 Blunt



HAND HELD RETRACTORS



SENN-MILLAR

L29-07931
 165mm (6.1/2")



KILNER

L29-07937
 150mm (6")



L29-07933
 Blade: 9mm x 12mm



L29-07934
 Blade: 13mm x 16mm



L29-07932
DESMARRES
 140mm (5.1/2")



L29-07935
 Blade: 13mm x 18mm



L29-07936
 Blade: 11mm x 14mm



RETRACTOR



L30-07938
Blades: 25mm x 19mm
Small

L30-07939
Blades: 35mm x 29mm
Large



HAJEK

L30-07940
165mm (6.1/2")

KILNER
150mm (6")



L30-07941
Standard

L30-07942
Small



GILLIES SKIN HOOK
180mm (7")



MCINDOE SKIN HOOK
L30-07943
191mm (7.1/2")



BARSKY SKIN HOOK

L30-07944
152mm (6")
Double, adjustable



HAND HELD RETRACTORS



MCINDOE SKIN HOOK

152mm (6")
 Double



L31-07945
 9mm wide



L31-07946
 10mm wide



L31-07947
 11mm wide



EAST GRINSTEAD SKIN HOOK

L31-07948
 150mm (6")



KILNER ALAE
 80mm (3.1/4")
 sharp

L31-07949
 10mm wide

L31-07950
 13mm wide



BOWDLER-HENRY RAKE

L31-07951
 190mm (7.1/2")



WARDS CHEEK

L31-07952
 152mm (6")

HAND HELD RETRACTORS



CAIRNS "RAKE"
 220mm (8.3/4")



L32-07953
 Blade 16mm x 14mm
 Sharp



L32-07954
 Blade 14mm x 18mm
 Sharp

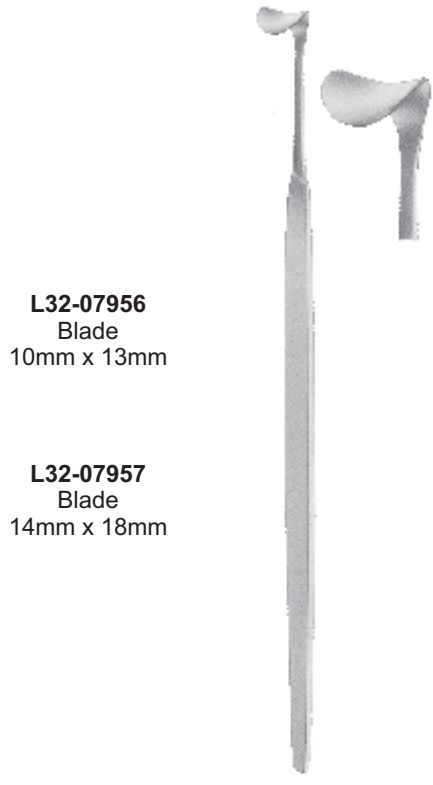

**CAIRNS
 (CUSHING)**
 205 mm (8")



CAIRNS STRIP
 200mm (8")
 Malleable

L32-07958
 6mm wide

L32-07959
 8mm wide

L32-07960
 10mm wide

L32-07961
 11mm wide

L32-07962
 13mm wide

L32-07963
 16mm wide

L32-07964
 19mm wide

L32-07965
 25mm wide

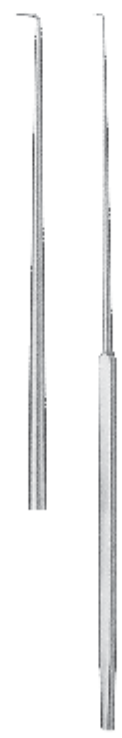

ADSON
L32-07966
 190mm (7.1/2")
 sharp

HAND HELD RETRACTORS



CUSHING BRAIN SPOON

180mm (7")
 Flexible

L33-07967

Set of four consisting of:

- 1 x L33-07968
- 1 x L33-07969
- 1 x L33-07970
- 1 x L33-07971

L33-07969

Ends: 11mm and 13mm

L33-07970

Ends: 15mm and 18mm

L33-07971

Ends: 18mm and 22mm

L33-07968

Ends: 7mm and 9mm



CRILE

L33-07972
 200mm (8")



CUSHING

L33-07973
 190mm (7.1/2")



CAIRNS

L33-07974
 125mm (5")
 Sharp

HAND HELD RETRACTORS



ST-BRATS MODEL
L34-07975
 140mm (5.1/2")
 Blunt

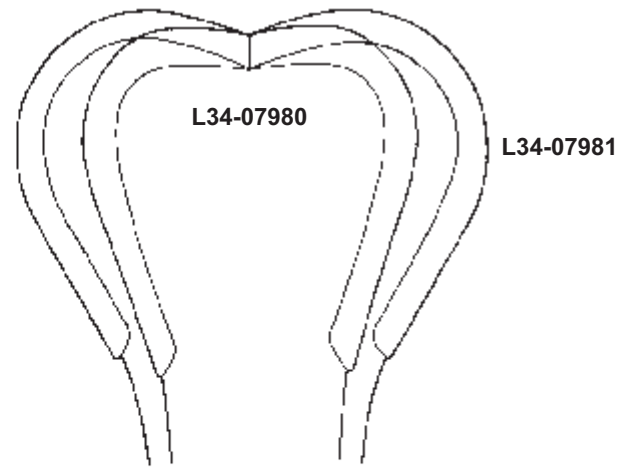

L34-07980 **L34-07981**

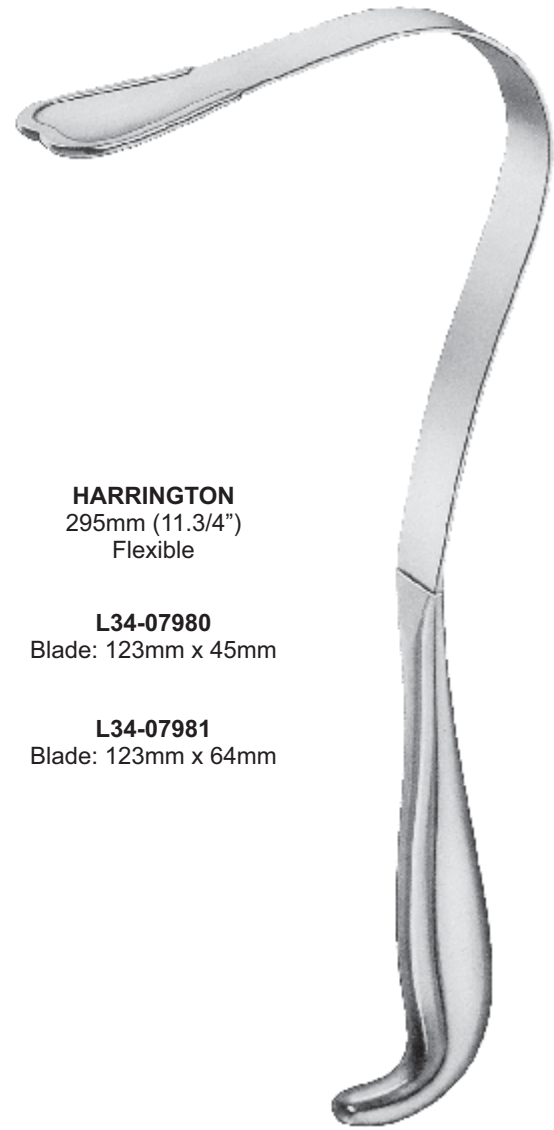

HARRINGTON
 295mm (11.3/4")
 Flexible

L34-07980
 Blade: 123mm x 45mm

L34-07981
 Blade: 123mm x 64mm



L34-07976
 Single Hook,
 Blunt

L34-07978
 Single Hook,
 Sharp

L34-07977
 Double Hook,
 Blunt

L34-07979
 Double Hook,
 Sharp

TRACHEAL HOOK
 180mm (7")

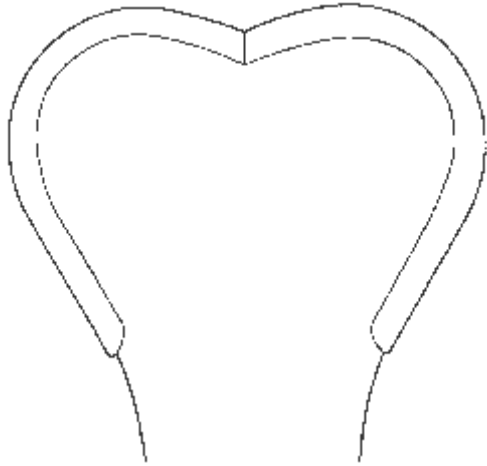

HARRINGTON - PEMBERTON
Flexible

L35-07982
295mm (11.3/4")
Blade: 175mm x 64mm



ALLISON
L35-07983
255mm (10")
Blade: 40mm wide

HAND HELD RETRACTORS



ALLISON
L36-07984
 320mm (12.3/4")
 Blade: 54mm wide

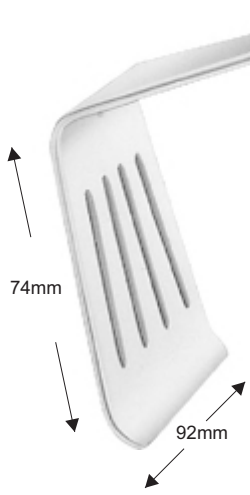
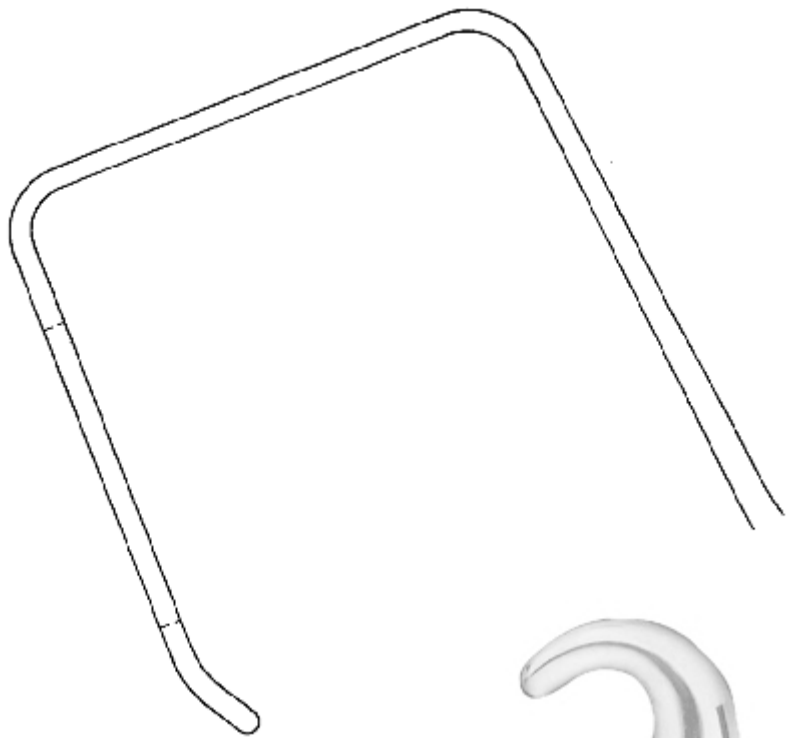

DAVIDSON
L36-07985
 195mm (7.3/4")
 Scapula retractor

SELF RETAINING RETRACTORS

TURNER WARWICK ABDOMINAL RETRACTOR SET

Set consists of:

- 1 x L37-07986
- 1 x L37-07987
- 1 x L37-07988
- 1 x L37-07989
- 2 x L37-07990
- 2 x L37-07991
- 2 x L37-07992
- 2 x L37-07993
- 2 x L37-07994
- 2 x L37-07995
- 2 x L37-07996
- 2 x L37-07997
- 2 x L37-07998

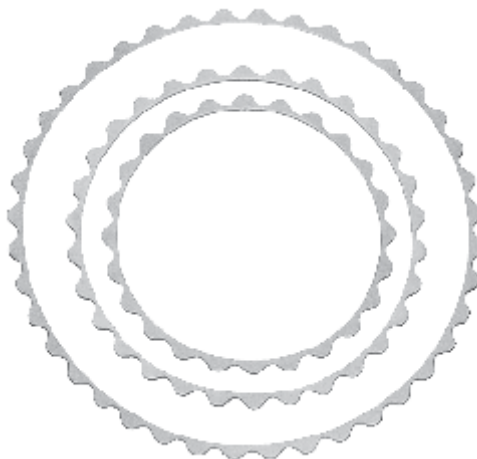

TURNER WARWICK RETRACTOR FRAMES

Circular

L37-07986
 178mm (7") diameter

L37-07987
 229mm (9") diameter

L37-07988
 305mm (12") diameter

L37-07989
 457mm x 330mm
 (18" x 13")

TURNER WARWICK RETRACTOR BLADES



L37-07990
 Blade: 19mm x 76 mm
 Flat, copper blade,
 blackened shaft

L37-07991
 Blade: 38mm x 102mm
 Flat, copper blade,
 blackened shaft with
 sliding retainer clip

L37-07992
 Blade: 57mm x 89mm
 Flat, copper blade,
 blackened shaft with
 sliding retainer clip

L37-07993
 Blade: 57mm x 114mm
 Flat, copper blade,
 blackened shaft with
 sliding retainer clip

SELF RETAINING RETRACTORS

TURNER WARWICK RETRACTOR BLADES



L38-07994

Blade: 51mm x 38mm
 Curved, blackened finish

L38-07995

Blade: 76mm x 60mm
 Curved, blackened finish



L38-07996

Blade: 89mm x 60mm
 Flat, polished front surface

L38-07997

Blade: 114mm x 60mm
 Flat polished front surface



L38-07998

13mm deep
 Single hook blade

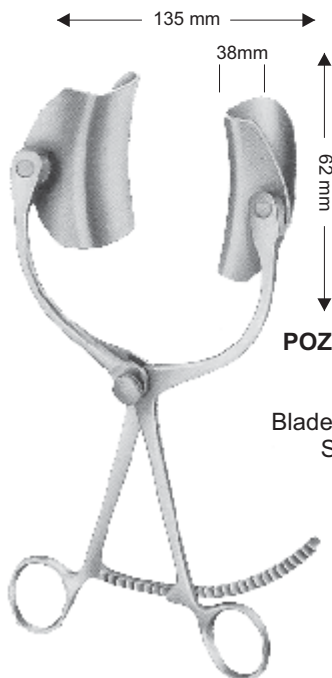

POZZI ABDOMINAL

L38-07999
 Blades: 62mm x 38mm
 Swivel blades



POZZI ABDOMINAL

L38-08000
 Lateral blades:
 62mm x 38mm
 Center blade:
 55mm x 55mm

RETRACTOR



RICARD

L39-08001

Lateral blades: 58mm x 80mm
 Centre blade: 54mm x 70mm

L39-08002

Lateral blades: 72mm x 84mm
 Centre blade: 72mm x 90mm

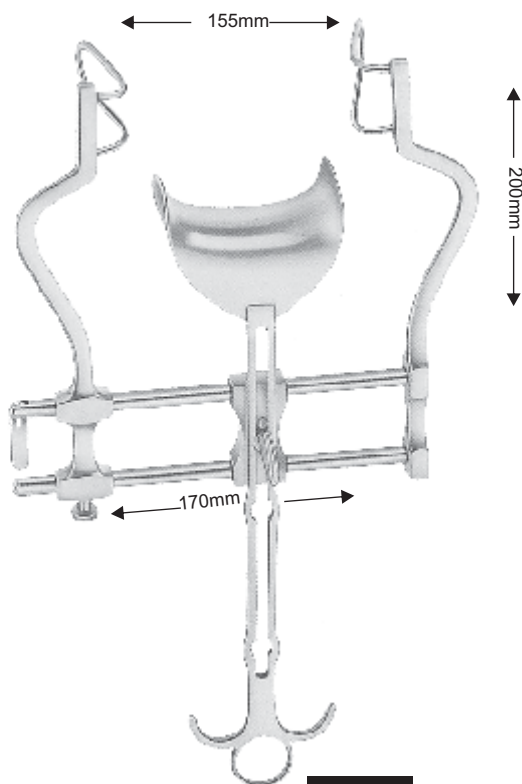

BALFOUR ABDOMINAL

L39-08003

Lateral blades: 60mm
 Centre blade: 47mm x 80mm

L39-08004

Lateral blades: 60mm
 Centre blade: 62mm x 76mm

L39-08005

Lateral blades: 90mm
 Centre blade: 80mm x 80mm

L39-08006

Lateral blades: 105mm
 Centre blade: 59mm x 107mm

RETRACTOR

KIRSCHNER RETRACTOR SET

L40-08007

Set comprising of:
 1 x L40-08008
 2 x L40-08009
 2 x L40-08010

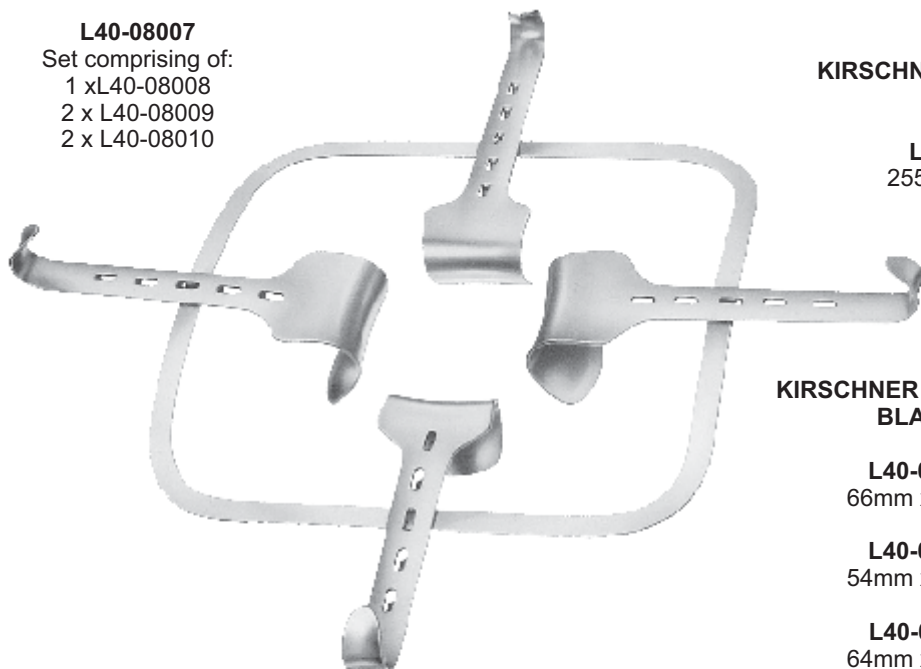

KIRSCHNER RETRACTOR FRAME

L40-08008
 255mm square

KIRSCHNER RETRACTOR BLADES

L40-08009
 66mm x 48mm

L40-08010
 54mm x 42mm

L40-08011
 64mm x 80mm

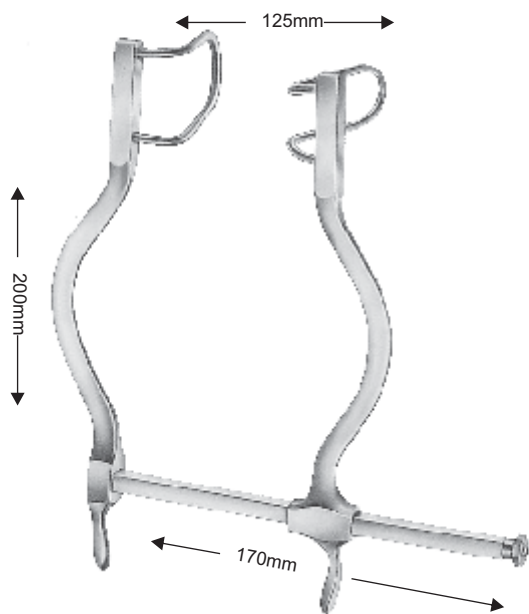

GOSSET

L40-08012
 Blades: 55mm

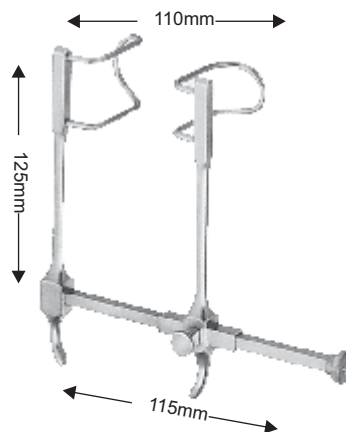

GOSSET

L40-08013
 Blades: 38mm

SELF RETAINING RETRACTORS



**STERNAL / ABDOMINAL
 RETRACTOR**

L41-08014

Mounting frame for fastening to both sides of the lateral bars of the operating table which will give more stability. Can be dismantled for sterilization



**STERNAL / ABDOMINAL
 RETRACTOR BLADES**

L41-08015
 48mm x 90mm

L41-08016
 48mm x 105mm

L41-08017
 48mm x 120mm

L41-08018
 48mm x 135mm

L41-08019
 48mm x 155mm

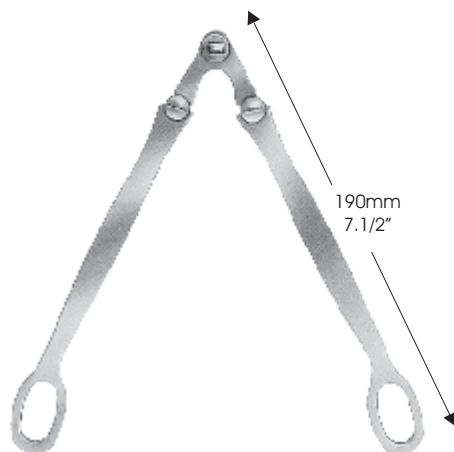

STERNAL / ABDOMINAL RETRACTOR FIXATION DEVICE

L41-08020

Fixation device for blades

SELF RETAINING RETRACTORS

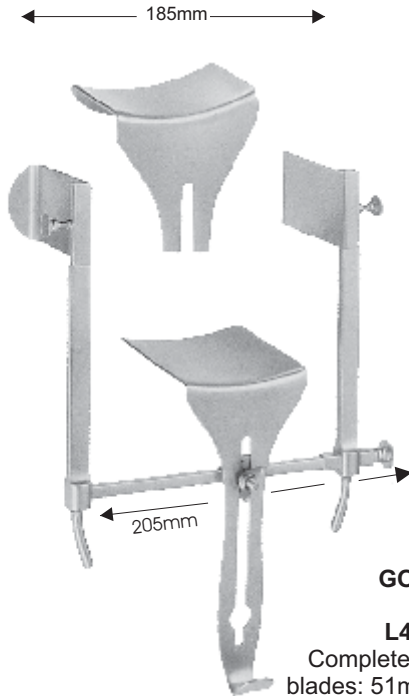

GOLIGHER

L42-08021
 Complete with two centre blades: 51mm deep, and four lateral blades:
 2 x 51mm deep
 2 x 102mm deep

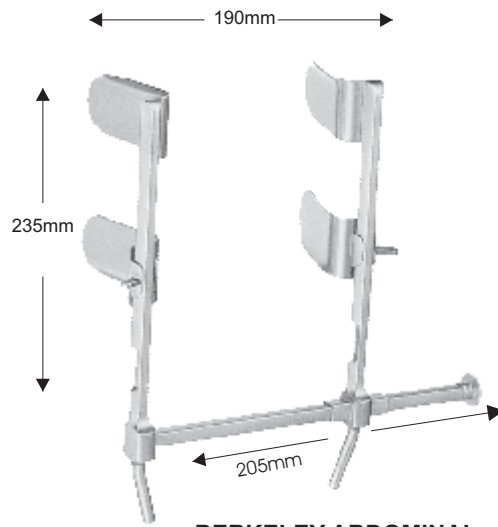

BERKELEY ABDOMINAL

L42-08022
 Blades: 35mm x 60mm



TRAVERS

L42-08023
 200mm (8")
 4 x 5 teeth
 Blunt



IRWIN

L42-08024
 178mm (7")
 4 x 5 teeth
 Sharp

SELF RETAINING RETRACTORS



WEISLANDER

L43-08025
 110mm (4.3/8")
 2 x 3teeth, sharp



WEISLANDER

L43-08026
 110mm (4.3/8")
 2 x 3 teeth. blunt



RNTNE HOSPITAL

L43-08027
 159mm (6.1/4")
 3 x 4 teeth



NORFOLK AND NORWICH

L43-08028
 215mm (8.1/2")
 4 x 5 teeth, blunt

SELF RETAINING RETRACTORS



WEISLANDER
3 x 4 teeth, blunt

L44-08029
130mm (5.1/8")

L44-08030
156mm (6.1/2")



WEISLANDER
3 x 4 teeth, sharp

L44-08031
130mm (5.1/8")

L44-08032
165mm (6.1/2")



WEISLANDER
3 x 4 teeth, semi sharp

L44-08033
130mm (5.1/8")

L44-08034
165mm (6.1/2")

SELF RETAINING RETRACTORS



WEISLANDER



L45-08035
 195mm (7.3/4")
 3 x 4 teeth
 sharp



L45-08036
 240mm (9.1/2")
 3 x 4 teeth
 sharp



L45-08037
 255mm (10")
 5 x 6 teeth
 sharp



L45-08038
 195mm (7.3/4")
 3 x 4 teeth
 blunt



L45-08039
 240mm (9.1/2")
 3 x 4 teeth
 blunt



L45-08040
 255mm (10")
 5 x 6 teeth
 blunt

SELF RETAINING RETRACTORS



JOLL THYROID

L46-08041
 152mm (6")

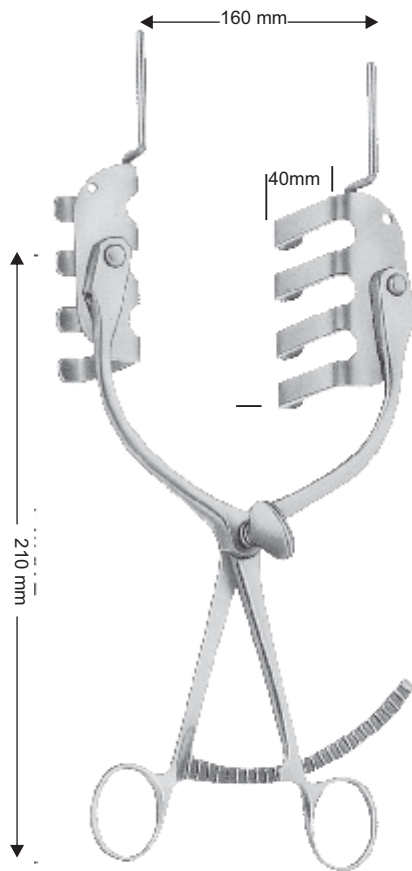

ST MARKS HOSPITAL PERINEAL
 210mm (8.3/8")

L46-08042
 Blades: 70mm x 40mm



MILLIN RETROPUBIC

L46-08043
 Blades
 55mm x 25mm
 80mm x 25mm

Centre blade:
 115mm x 45mm

SELF RETAINING RETRACTORS

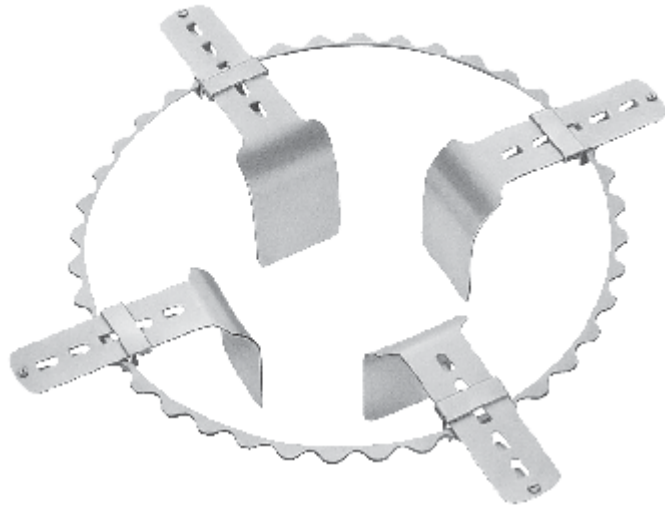

TURNER WARWICK

L47-08044
 140mm x 180mm (7" x 5.1/2")
 Oval sprocket frame and four blades



GELPI VULVA

L47-08045
 165mm (6.1/2")



GELPI VULVA

L47-08046
 135mm (5.1/4")



JACKSON - BURROWS

L47-08047
 165mm (6.1/2")



FINSON

L47-08048
 70mm (2.3/4")

SELF RETAINING RETRACTORS



L48-08049
 100mm (4")



ALMS

L48-08050
 70mm (2.3/4")
 sharp / blunt

L48-08051
 100mm (4")
 sharp blunt



LOGAN

L48-08052
 50mm (2")



KILNER SKIN

L48-08053
 50mm (2")
 Small teeth



KILNER SKIN

L48-08054
 50mm (2")
 Long teeth



CAIRNS SCALP

L48-08055
 140mm (5.1/2")
 Curved, swivel blades, sharp

SELF RETAINING RETRACTORS

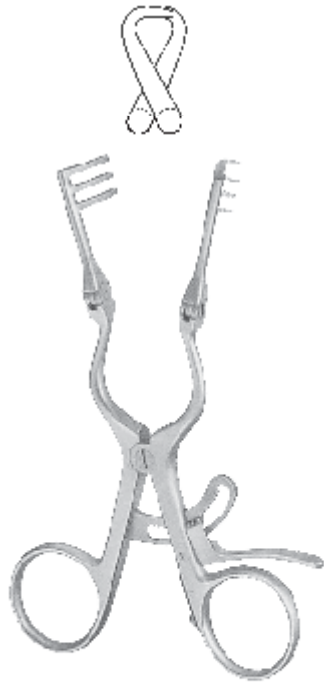

CONE

L49-08056
 145mm (5.3/4")



JANSON (SHEA)

L49-08057
 105mm (4.1/8")

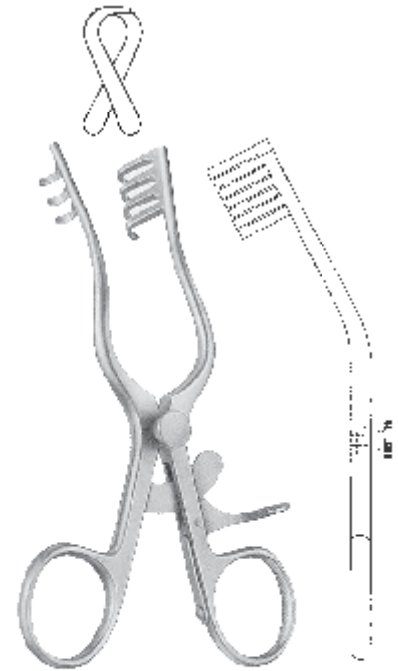

JEFFERSON

L49-08058
 140mm (5.1/2")



HENDERSON

L49-08059
 130mm (5.1/8")



TRAVERS

L49-08060
 195mm (7.3/4")
 Sharp

SELF RETAINING RETRACTORS



CONE LAMINECTOMY

L50-08061
 254mm (10"), Hinged arms

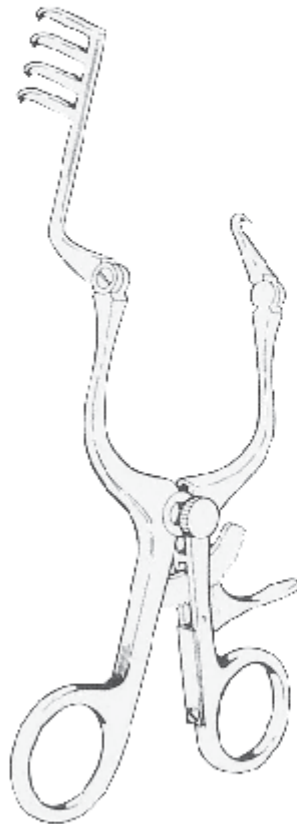

CONE HEMI-LAMINECTOMY
 Left hinged arm

L50-08062
 165mm (6.1/2")

L50-08063
 254mm (10")

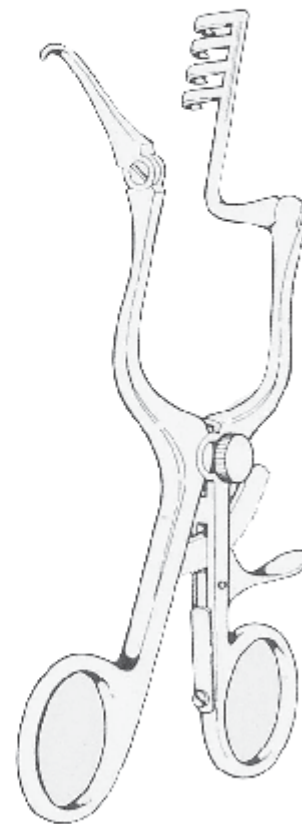

CONE HEMI-LAMINECTOMY
 Right hinged arm

L50-08064
 165mm (6.1/2")

L50-08065
 254mm (10")

SELF RETAINING RETRACTORS



HARVEY-JACKSON LAMINECTOMY

L51-08066
280mm (11.1/2")
Blades: 38mm x 44mm

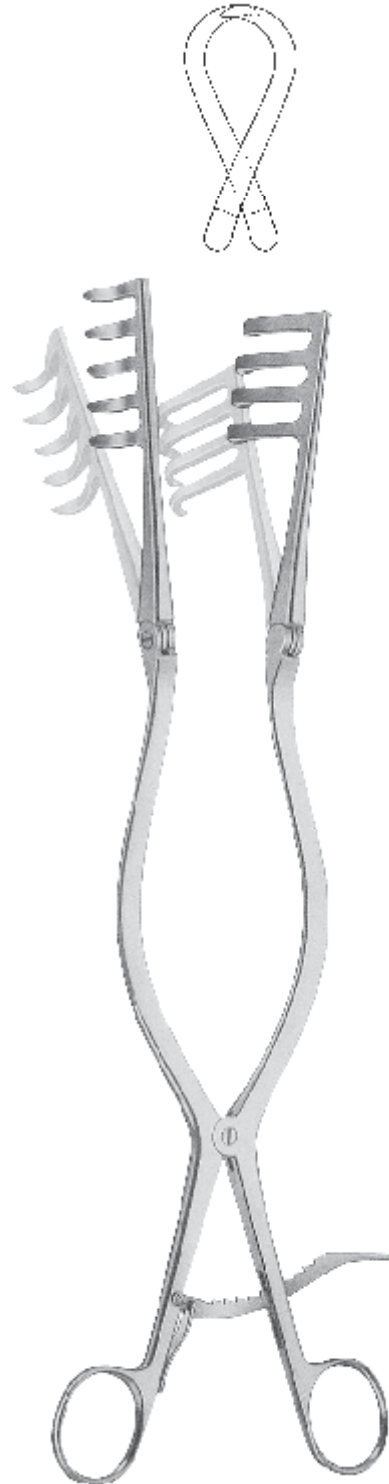

MAYO-ADSON (BECKMANN) LAMINECTOMY

L51-08067
280mm (11.1/2")
Blades: 38mm x 44mm

SELF RETAINING RETRACTORS

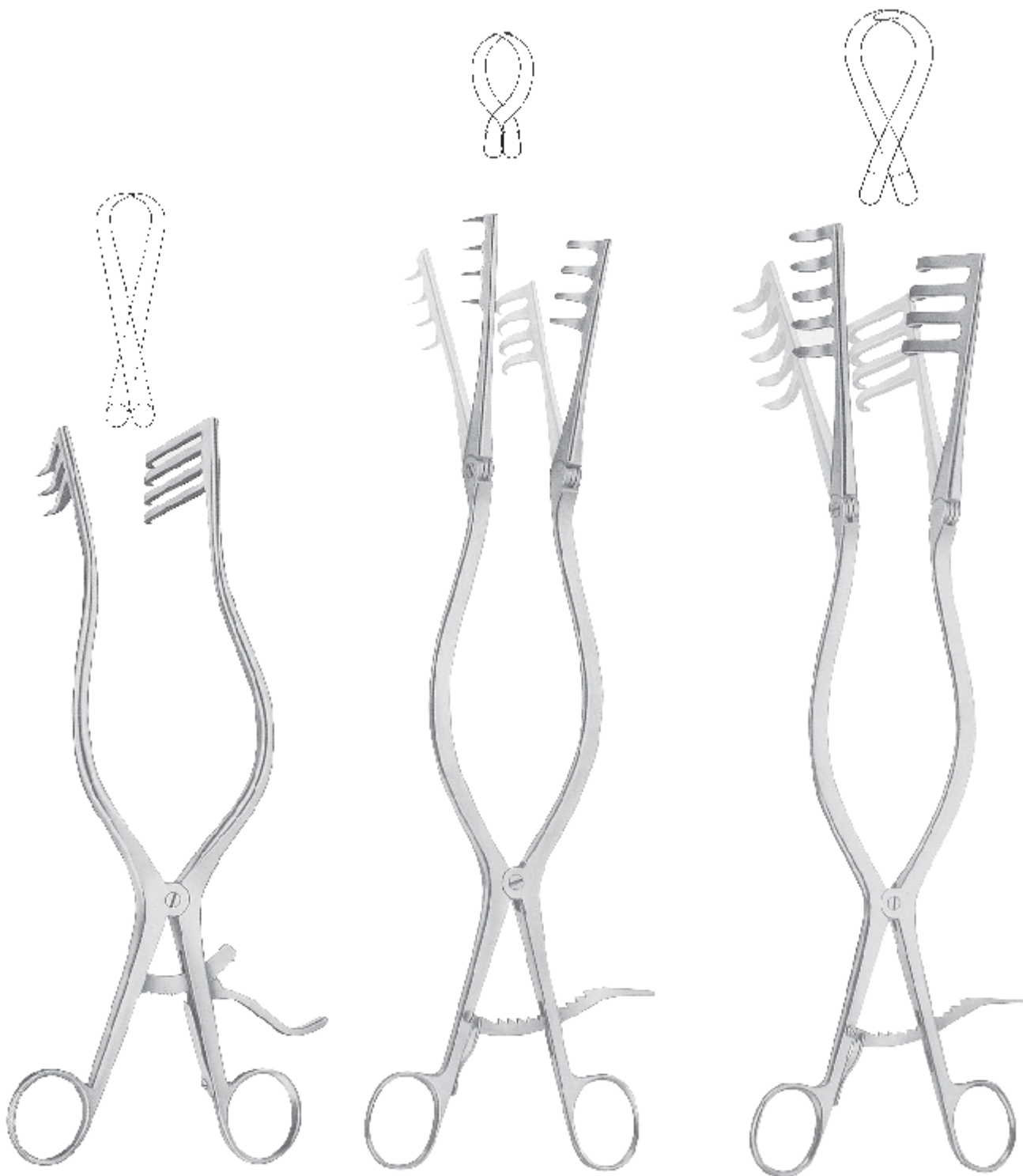

ADSON

L52-08068
 265mm (10.1/2")

BECKMANN-ADSON

L52-08069
 310mm (12")

ADSON

L52-08070
 320mm (12.3/4")
 Semi - sharp
 E-mail: info@baileysurgico.com

SELF RETAINING RETRACTORS

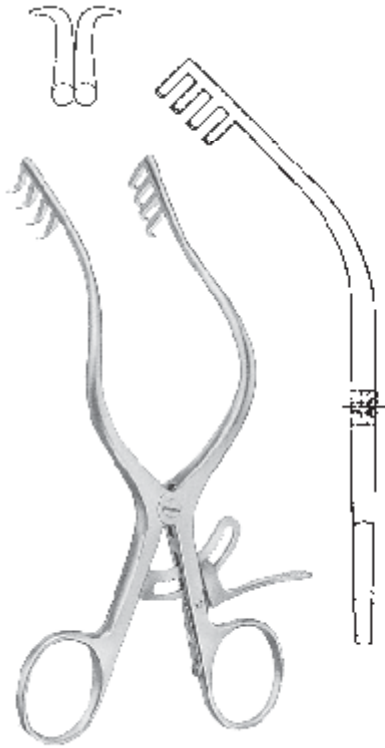

MOLLISON
 L53-08071
 165r



MOLLISON
 L53-08072



PLESTER-JANSEN
 L53-08073



PLESTER-JANSEN
 Right
 L53-08074
 140mm (5.1/2")

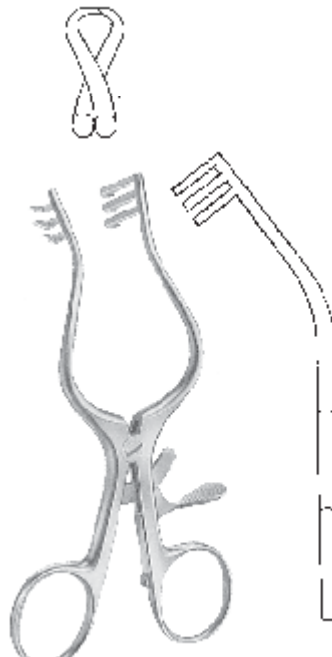

PLESTER-JANSEN
 L53-08075
 140mm (5.1/2")

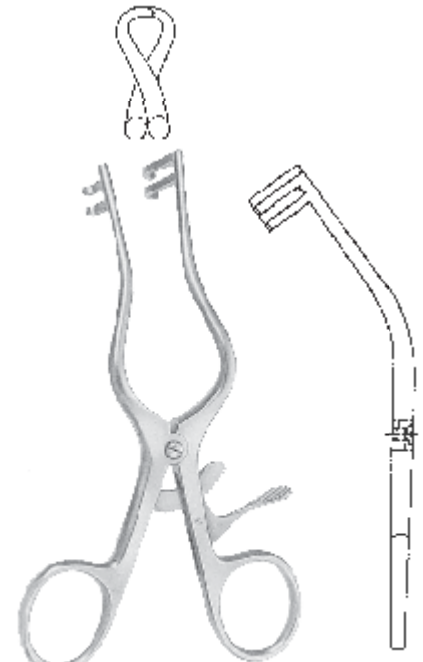

WALACE MODIFIED
PLESTER-JANSEN
 L53-08076
 140mm (5.1/2")

SELF RETAINING RETRACTORS



**CHARNLEY INITIAL INCISION
 RETRACTOR**
 with weight and chain

L54-08078

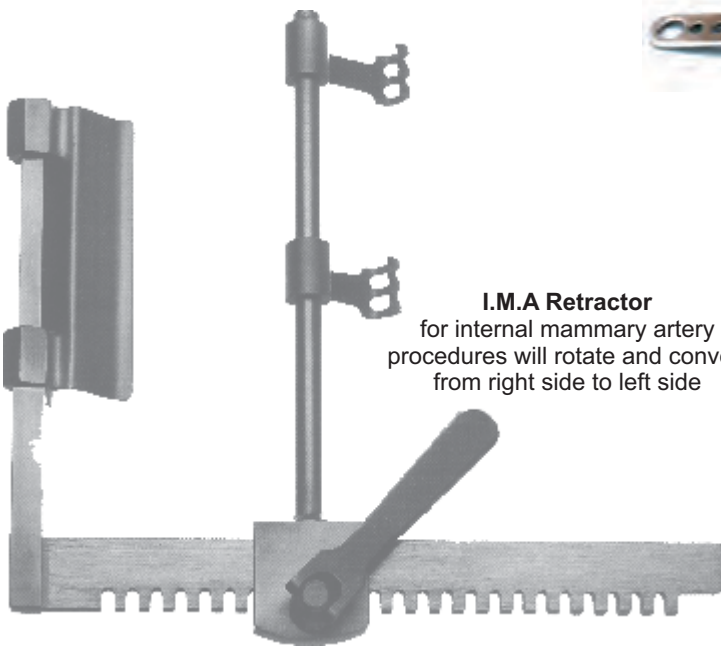

I.M.A Retractor
 for internal mammary artery
 procedures will rotate and convert
 from right side to left side

I.M.A RETRACTOR

L54-08077



**CHARNLEY
 PIN RETRACTOR**

L54-08079

TROCARS



NESTED TROCARS

M1-09000
 171mm (6.3/4")
 1.9mm, 3.3mm, 4.5mm and 6.0mm
 Set of four

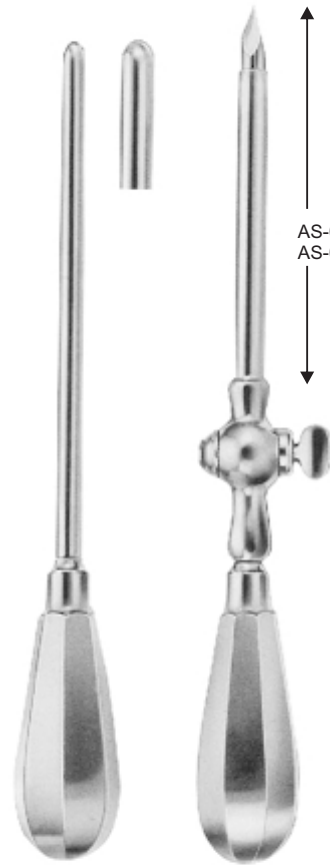

AS-09005 100mm
 AS-09006 110mm

SUPRAPUBIC

M1-09005
 I.D. 9.0mm O.D. 10.0mm

M1-09006
 I.D. 7.0mm O.D. 8.0mm

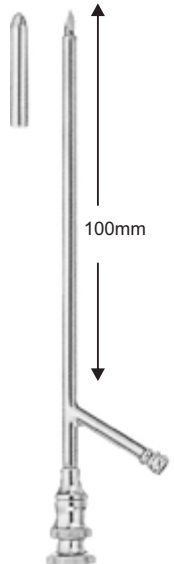

OSCHNER GALL BLADDER

M1-09001
 I.D. 3.6mm O.D. 4.6mm

M1-09002
 I.D. 5.0mm O.D. 6.0mm

M1-09003
 I.D. 3.0mm O.D. 4.0mm

M1-09004
 I.D. 4.3mm O.D. 5.3mm

INSTRUMENTS

TROCARS



NELSON EMPYEMA
191mm (7.1/2")

M2-09011
22fg (7.33mm)

M2-09012
27fg (9mm)

M2-09013
33fg (11mm)

**TILLEY LICHTWITZ
ANTRAL**
Cannula: 102mm (4")
Trocar: 197mm (7.3/4")

M2-09007
5fg (1.66mm)

M2-09008
6fg (2mm)

M2-09009
7fg (2.33mm)

M2-09010
8fg (2.66mm)

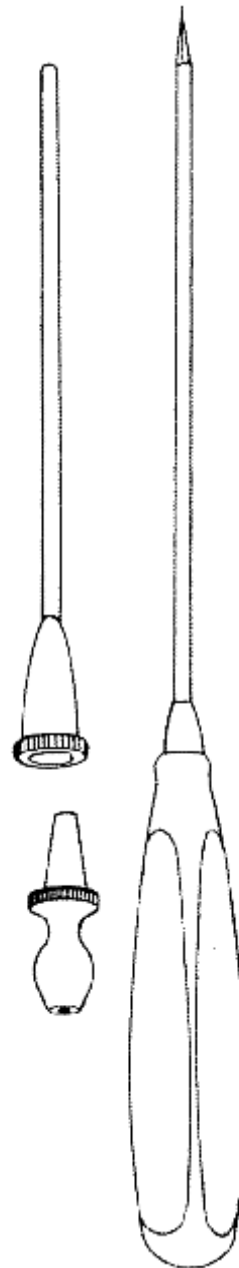

■■■■■
**CHOLECYSTECTOMY
& GALL STONE**

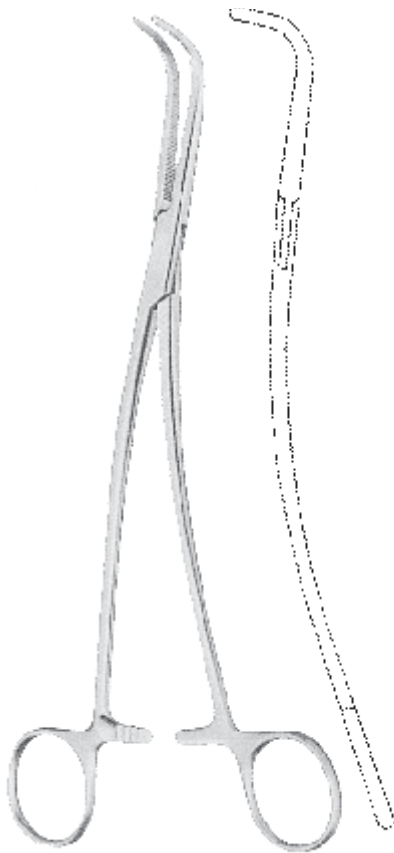

GEARY GRANT

N1-09200
230mm (9")
Large curved



LAHEY

N1-09201
195mm (7.3/4")

N1-09202
230mm (9")



LOWER

N1-09203
180mm (7")



**CHOLECYSTECTOMY
 & GALL STONE**



MIXSTER
N2-09204
 220mm (8.3/4")
N2-09205
 250mm (10")

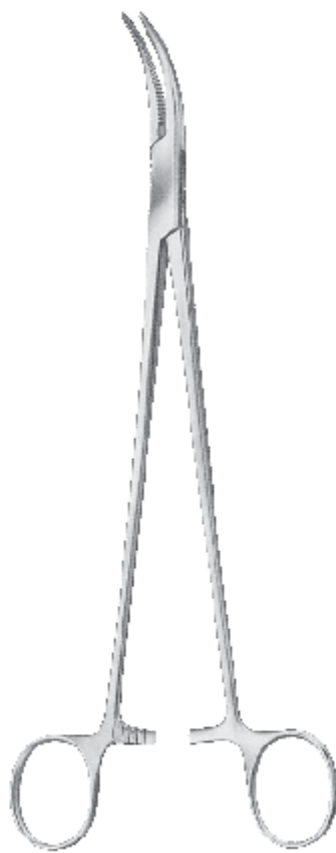

MOYNIHAN
N2-09206
 230mm (9")



**MOUAT GALL BLADDER
 LIFTING FORCEPS**
N2-09207
 215mm (8.1/2")

CHOLECYSTECTOMY
 & GALL STONE

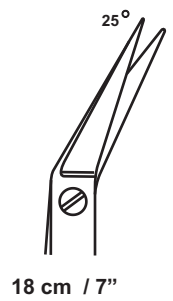
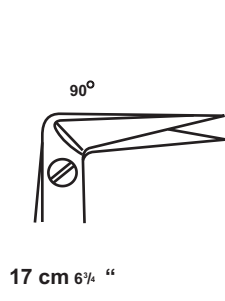

**POTTS-DE
 MARTEL**
 N3-09208
 220mm (8.3/4")

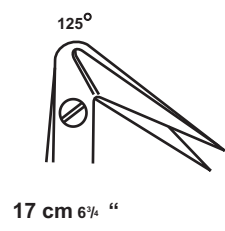

MILLS
 N3-09209
 230mm (8.3/4")



GALL DUCT SCISSORS

GALL DUCT PROBES



MOYNIHAN

N4-09210
 345mm (13.3/4")
 Gall stone probe and scoop
 malleable

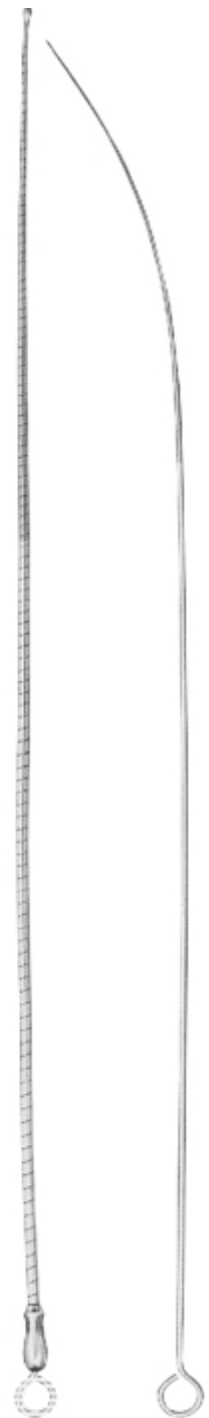

OCHSNER

N4-09211
 400mm (16")
 Gall duct probe flexible



DESJARDINS

285mm (11.1/4")
 Gall duct probes, flexible

3.8mm diameter

N4-09212

4.3mm diameter

N4-09213

6.8mm diameter

N4-09214

GALL DUCT DILATORS / SCOOPS

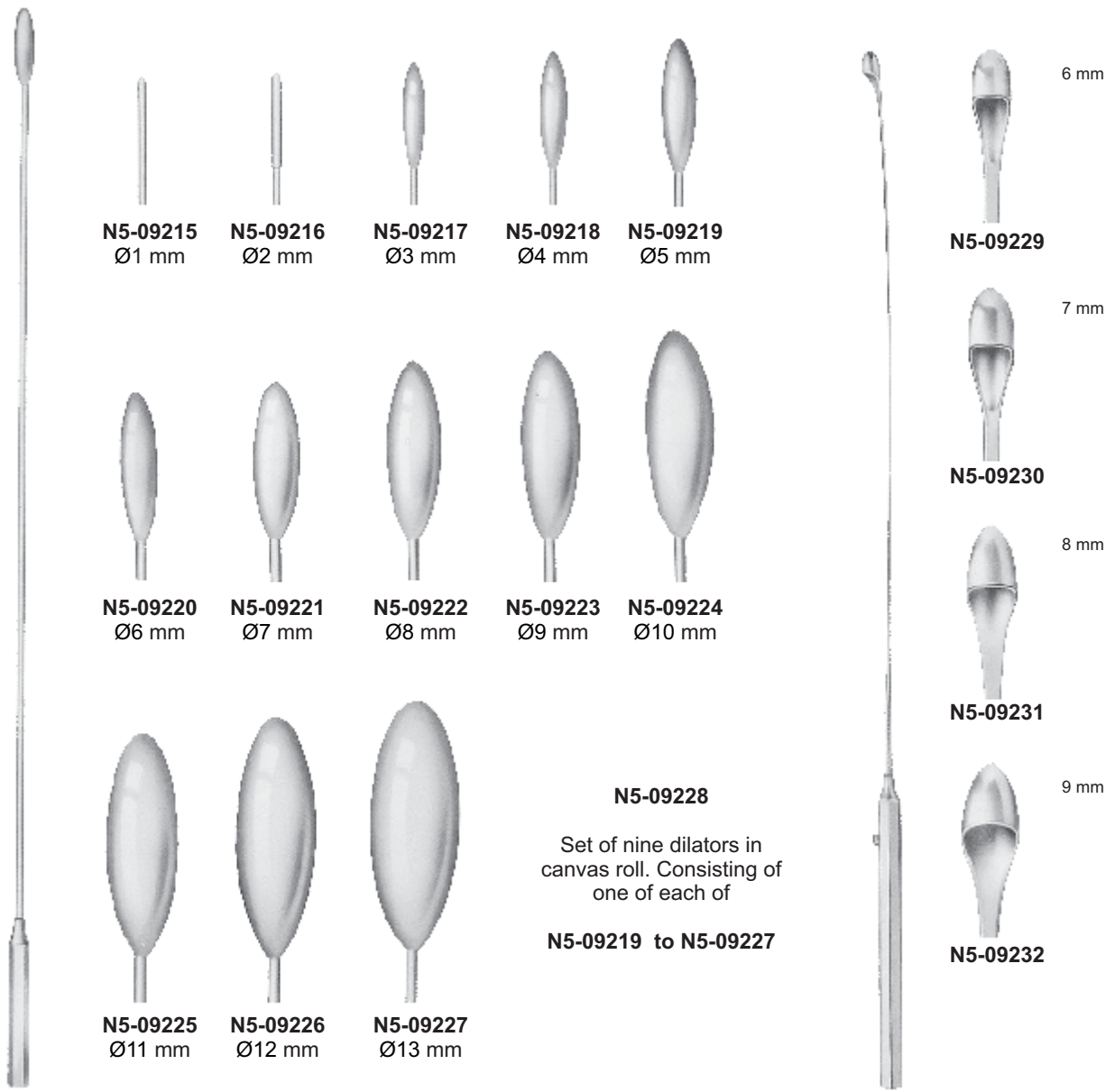

N5-09215
 Ø1 mm

N5-09216
 Ø2 mm

N5-09217
 Ø3 mm

N5-09218
 Ø4 mm

N5-09219
 Ø5 mm

N5-09229

6 mm

N5-09220
 Ø6 mm

N5-09221
 Ø7 mm

N5-09222
 Ø8 mm

N5-09223
 Ø9 mm

N5-09224
 Ø10 mm

N5-09230

7 mm

8 mm

N5-09231

9 mm

N5-09225
 Ø11 mm

N5-09226
 Ø12 mm

N5-09227
 Ø13 mm

N5-09228
 Set of nine dilators in
 canvas roll. Consisting of
 one of each of
N5-09219 to N5-09227

N5-09232

BAKES
 300mm (12")

Common bile duct dilators, malleable

DESJARDINS
 300mm (12")

Probe and catch
 with flexible shaft

GALL STONE SCOOPS / FORCEPS

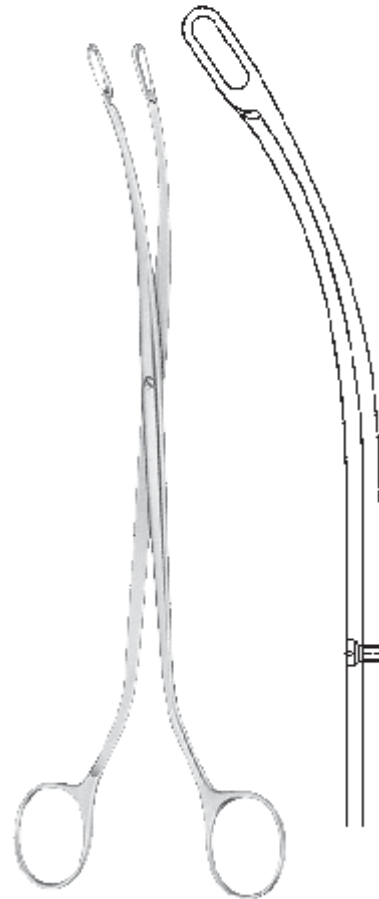
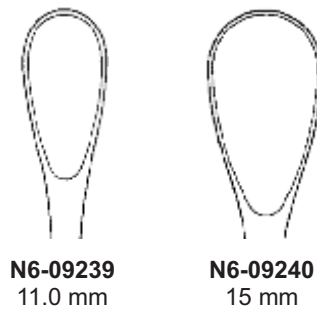
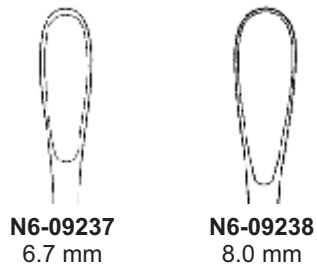
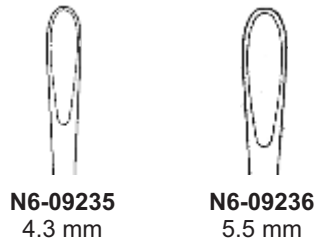
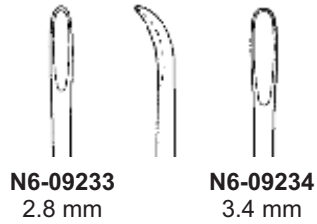

SCOOP
310mm (12")

With malleable shaft

DESJARDINS
225mm (9")

**CHOLECYSTECTOMY AND
 GALL STONE FORCEPS**



BLAKE
N7-09243
 205mm (8")
 Straight



BLAKE
N7-09244
 205mm (8")
 Curved

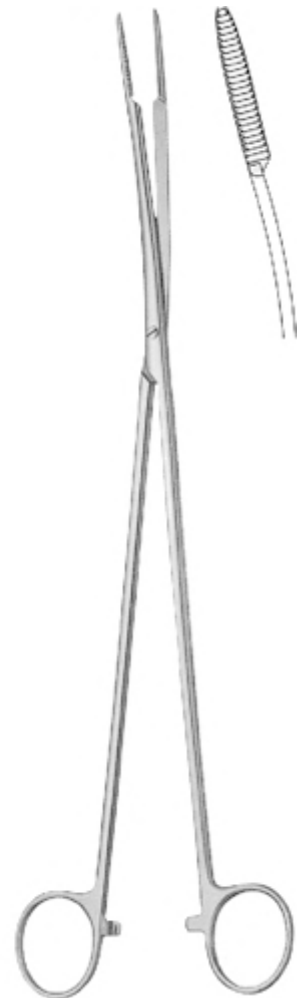

**DUCT DISSECTING / DILATING
 FORCEPS**
N7-09245
 260mm (10.1/4")

CHOLECYSTECTOMY AND GALL STONE FORCEPS



**CHOLANGIOGRAM CANNULA
INTRODUCING FORCEPS**

N8-09246
280mm (11")
Grooved jaw, for use with
Stoke - on - Trent Cannula

INTESTINAL CLAMPS



DOYEN
 165mm (6.1/2")
 Spring blades



N9-09301
 Straight



N9-09302
 Curved



N9-09305
 Straight



N9-09306
 Curved

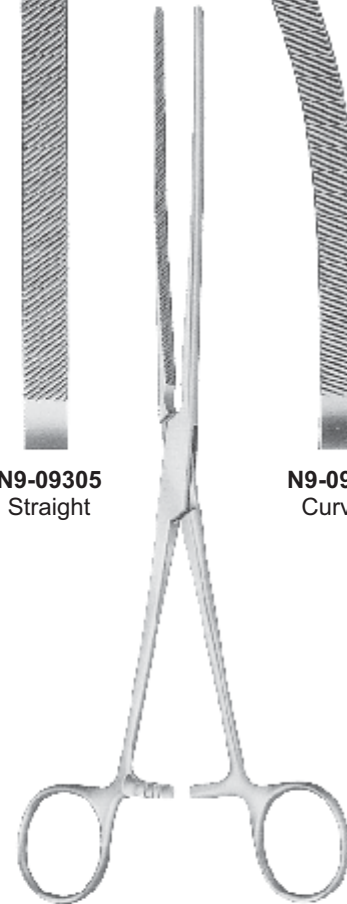

DOYEN
 235mm (9.3/4")
 Spring blades



DOYEN
 170mm (6.3/4")
 Spring blades



N9-09303
 Straight



N9-09304
 Curved

INTESTINAL CLAMPS

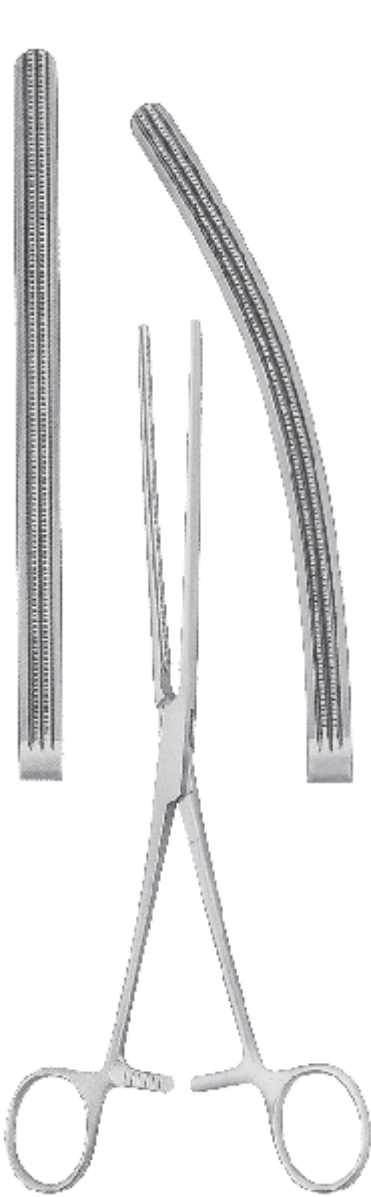

DOYEN
 230mm (9")
 Spring blades

N10-09307
 Straight

N10-09308
 Curved



DOYEN (KOCHER)
 Straight, light spring blade

N10-09309
 230mm (9")

N10-09310
 250mm (10")

N10-09311
 280mm (11")

N10-09312
 210mm (8.1/4")



DOYEN (MAYO ROBSON)
 Curved, light spring blade

N10-09313
 230mm (9")

N10-09314
 250mm (10")

N10-09315
 280mm (11")

N10-09316
 210mm (8.1/4")

INTESTINAL CLAMPS



KOCHER
 Spring blades

N11-09317
 250mm (10")

N11-09318
 280mm (11")

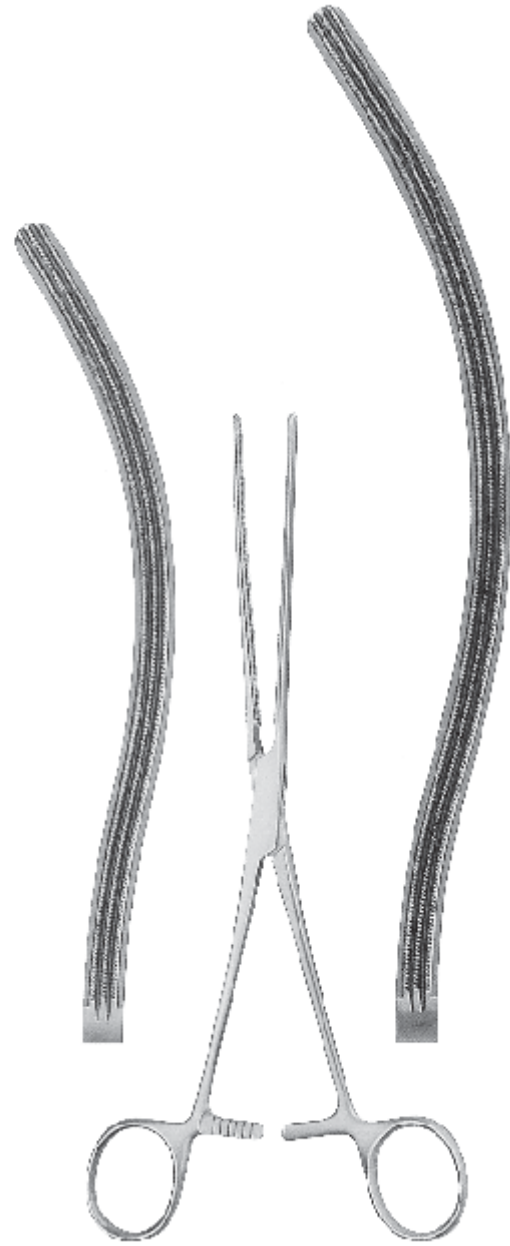

DOYEN (MAYO ROBSON)
 Spring blades

N11-09319
 250mm (10")

N11-09320
 280mm (11")

INTESTINAL CLAMPS



LANE
 N12-09321
 210mm (8.1/4")



**SETON PRINGLE
 (BAINBRIDGE)**
 N12-09322
 150mm (6") Straight
 N12-09323
 150mm (6") Curved



INTESTINAL CLAMPS



SCHOEMAKER
 Hollow blades for
 hemisphincterectomy

N13-09325
 170mm (6.3/4")

N13-09326
 215mm (8.1/2")

PARKER KERR
 Anastomosis forceps for
 colon resection

N13-09327
 250mm (10")

LANG STEVENSON

N13-09328
 200mm (8")

INTESTINAL CLAMPS



LLOYD DAVIS RECTAL OCCLUSION

N16-9335
 315mm (12.1/2")
 Angleg



RESANO

N16-9336
 265mm (10.1/2")
 Colon resection clamp

INTESTINAL CLAMPS



PAYR

N15-09331
 200mm (8")
 Jaw: 65mm

N15-09332
 280mm (11")
 Jaw: 100mm

N15-09333
 350mm (14")
 Jaw: 150mm



FINCH EXCISION

N15-09334
 230mm (9")
 Angled

INTESTINAL CLAMPS



LANE TWIN ANASTOMOSIS

N14-09329
 300mm (12") Curved



LANE TWIN ANASTOMOSIS

N14-09330
 300mm (12") Straight

INTESTINAL CLAMPS



HAYES
70 degree angled jaw
Colon resection clamp

N17-09337
265mm (10.1/2")
Jaw: 80mm

N17-09338
280mm (11")
Jaw: 100mm

VAGINAL SPECULUM

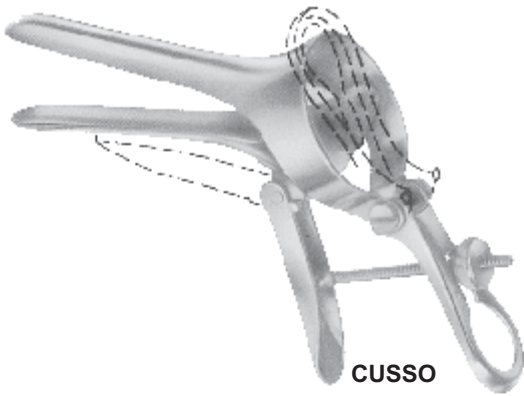

CUSCO
O1-09400
 75mm x 17mm
 Extra small for virgins

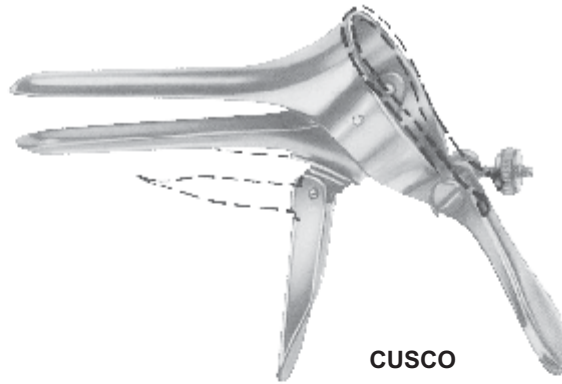

CUSCO
O1-09401
 75mm x 17mm
 Extra small for virgins

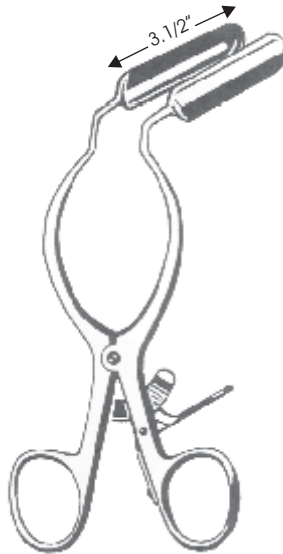

**McGEE LATERAL
 VAGINAL RETRACTOR**
 with ratch handle
O1-09405



CUSCO
O1-09402 110mm x 37mm
O1-09403 80mm x 32mm
O1-09404 80mm x 24mm

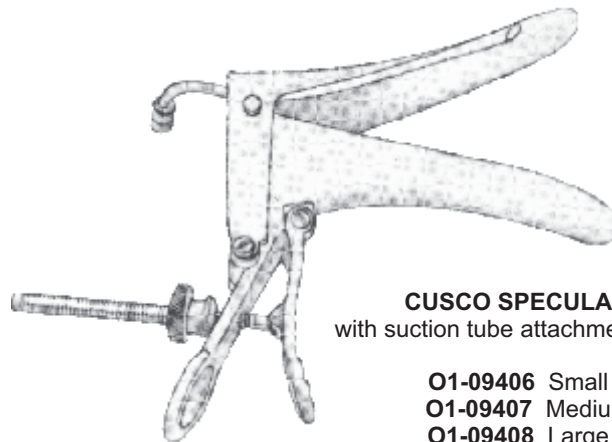

CUSCO SPECULAM
 with suction tube attachment black

- O1-09406** Small
- O1-09407** Medium
- O1-09408** Large

VAGINAL SPECULUM



GRAVE

- O2-09409** 75mm x 20mm
- O2-09410** 95mm x 30mm
- O2-09411** 195mm x 33mm

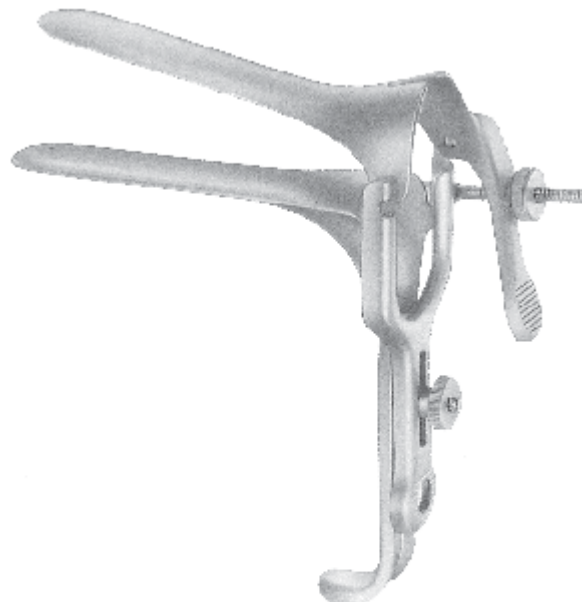

PEDERSON

- O2-09412** 100mm x 22 mm
- O2-09413** 120mm x 25mm



SIMS

- O2-09414**
 125mm (5")
 Small
 70mm x 26mm
 75mm x 30mm

- O2-09415**
 150mm (6")
 Medium
 75mm x 30mm
 80mm x 35mm

- O2-09416**
 175mm (7")
 Large
 80mm x 36mm
 90mm x 40mm

VAGINAL SPECULUM



Lower blade



Upper blade

O3-09417
 175mm (7")
 Blade:
 70mm x 15mm

O3-09421
 175mm (7")
 Blade:
 70mm x 10mm

O3-09418
 180mm (7")
 Blade:
 70mm x 27mm

O3-09422
 180mm (7")
 Blade:
 75mm x 23mm

O3-09419
 180mm (7")
 Blade:
 75mm x 30mm

O3-09423
 180mm (7")
 Blade:
 80mm x 25mm

O3-09420
 185mm (7.1/4")
 Blade:
 90mm x 36mm

O3-09424
 185mm (7.1/4")
 Blade:
 100mm x 32mm

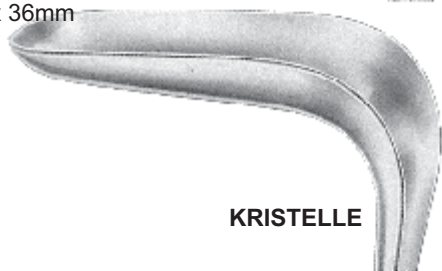

KRISTELLE

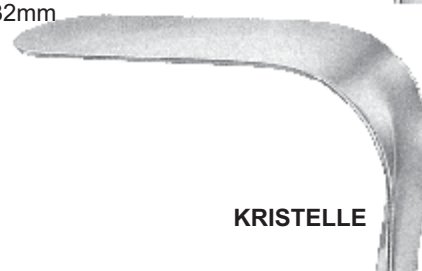

KRISTELLE

VAGINAL SPECULUM

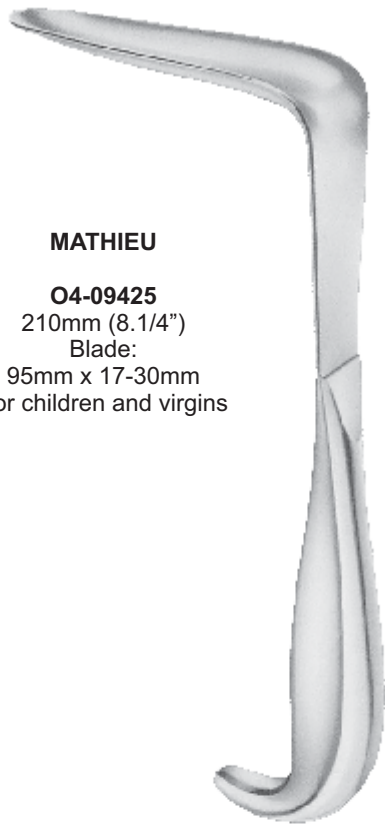

MATHIEU

O4-09425
 210mm (8.1/4")
 Blade:
 95mm x 17-30mm
 For children and virgins



MODIFIED WERTHEIM
 320mm (12.3/4")

O4-09432
 Blade: 100mm x 25mm

O4-09433
 Blade: 100mm x 30mm

O4-09434
 Blade: 100mm x 35mm

O4-09435
 Blade: 100mm x 40mm

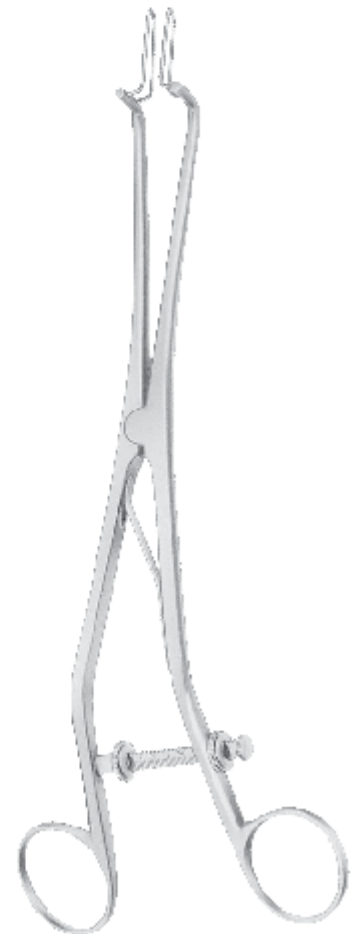

KOGAN ENDOCERVICAL SPECULUM

O4-09436
 240mm (9.1/2")
 Graduated

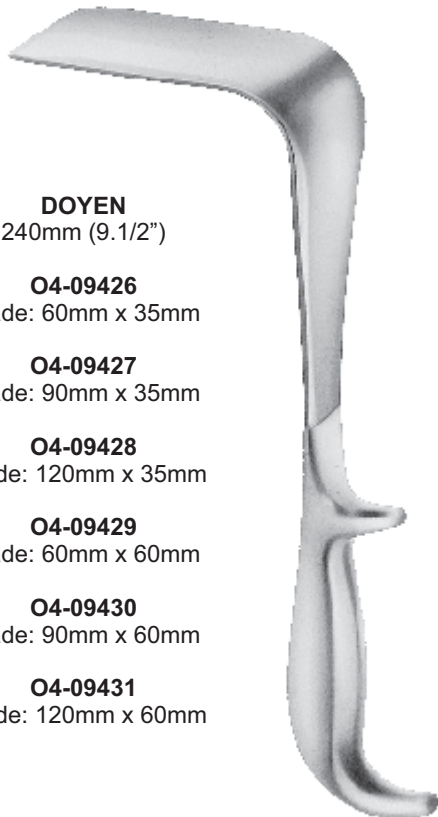

DOYEN
 240mm (9.1/2")

O4-09426
 Blade: 60mm x 35mm

O4-09427
 Blade: 90mm x 35mm

O4-09428
 Blade: 120mm x 35mm

O4-09429
 Blade: 60mm x 60mm

O4-09430
 Blade: 90mm x 60mm

O4-09431
 Blade: 120mm x 60mm

VAGINAL SPECULUM

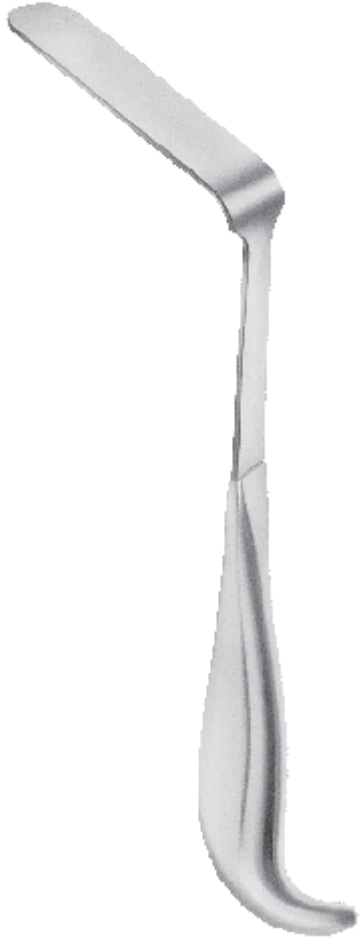

MODIFIED DOYEN
O5-09437
250mm (10")
Blade: 80mm x 30mm
Lateral Speculum



O5-09439

O5-09438

SIMON
275mm (10.3/4")
O5-09438
Blade: 115mm X 26mm
O5-09439
Blade: 115mm x 22mm

**VAGINAL RETRACTOR/
 UTERINE DILATORS**

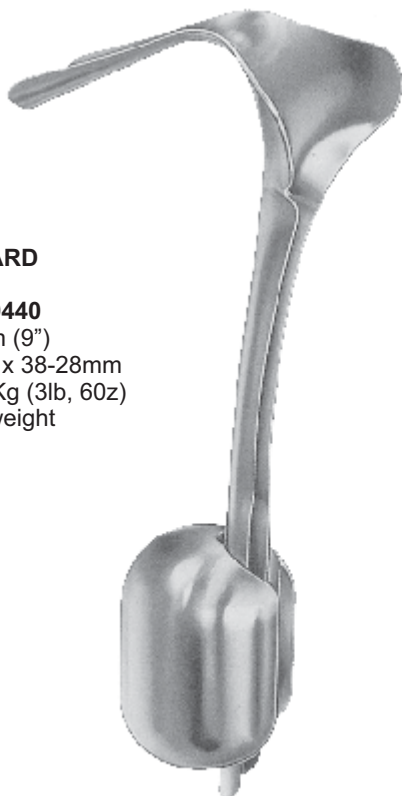

AUVARD

O6-09440
 230mm (9")
 Blade: 63mm x 38-28mm
 Weight: 1.53 Kg (3lb, 60z)
 Fixed weight

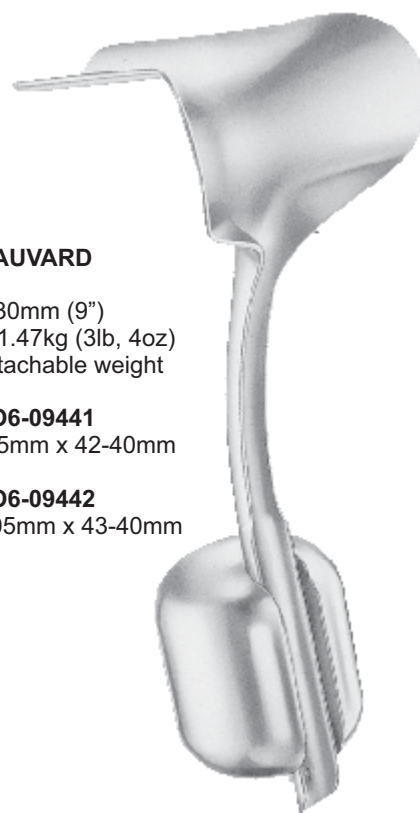

AUVARD

230mm (9")
 Weight: 1.47kg (3lb, 4oz)
 with detachable weight

O6-09441
 Blade: 75mm x 42-40mm

O6-09442
 Blade: 105mm x 43-40mm



O6-09443
 Set of twelve

- O6-09444** 6mm
- O6-09445** 7mm
- O6-09446** 8mm
- O6-09447** 9mm
- O6-09448** 10mm
- O6-09449** 11mm
- O6-09450** 12mm
- O6-09451** 13mm
- O6-09452** 14mm
- O6-09453** 15mm
- O6-09454** 16mm
- O6-09455** 17mm

HAWKIN AMBLER
 170mm (6.3/4")
 Cervix dilator



O6-09456
 Set of sixteen
 consisting of one of
 each of: 09457 to 09472

- | | | |
|----------------------|-----------------------|------------------------|
| O6-09457 2mm | O6-09468 13mm | O6-09479 8.5mm |
| O6-09458 3mm | O6-09469 14mm | O6-09480 9.5mm |
| O6-09459 4mm | O6-09470 15mm | O6-09481 10.5mm |
| O6-09460 5mm | O6-09471 16mm | O6-09482 11.5mm |
| O6-09461 6mm | O6-09472 17mm | O6-09483 12.5mm |
| O6-09462 7mm | O6-09473 2.5mm | O6-09484 13.5mm |
| O6-09463 8mm | O6-09474 3.5mm | O6-09485 14.5mm |
| O6-09464 9mm | O6-09475 4.5mm | O6-09486 15.5mm |
| O6-09465 10mm | O6-09476 5.5mm | O6-09487 16.5mm |
| O6-09466 11mm | O6-09477 6.5mm | O6-09488 17.5mm |
| O6-09467 12mm | O6-09478 7.5mm | |

HEGAR
 185mm (7.1/4")
 Cervix dilator

UTERINE DILATORS / PROBES



HEGAR
 205mm (8")
 Cervix dilator
 Double ended

O7-09489
 Set of eight consisting
 of one of each of:
 09491 to 09498

- O7-09490 1mm - 2mm
- O7-09491 3mm - 4mm
- O7-09492 5mm - 6mm
- O7-09493 7mm - 8mm
- O7-09494 9mm - 10mm
- O7-09495 11mm - 12mm
- O7-09496 13mm - 14mm
- O7-09497 15mm - 16mm
- O7-09498 17mm - 18mm



GALABIN
O7-09499
 290mm (11.1/2")
 Shaft graduated
 is cm's
 Malleable



SIMS
O7-09500
 330mm (13")
O7-09501
 330mm (13")
 Malleable



MARTIN
O7-09502
 300mm (12")

DRESSING FORCEPS



BROWN
O8-09503
 270mm (10.3/4")
 Uterine depressor



PELKMANN
 Straight
O8-09504
 260mm (10.1/4")

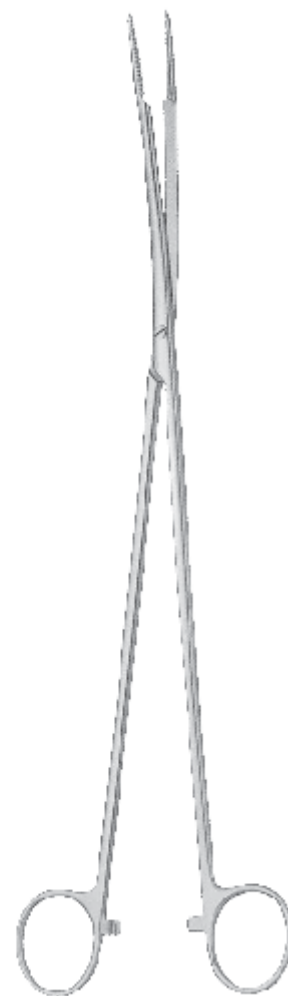

PELKMANN
 Curved
O8-09505
 260mm (10.1/4")

TENACULUM FORCEPS

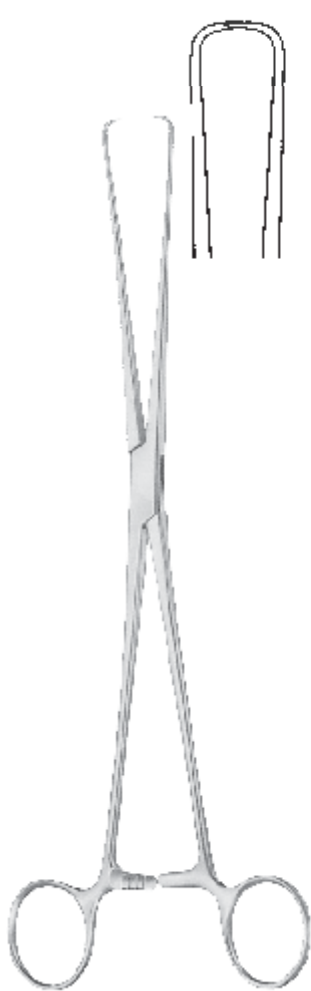

BROWN
O9-09506
250mm (10")
Slender



SCHROEDER
O9-09507
230mm (9")



WILSON
O9-09508
240mm (9.1/2")

TENACULUM FORCEPS

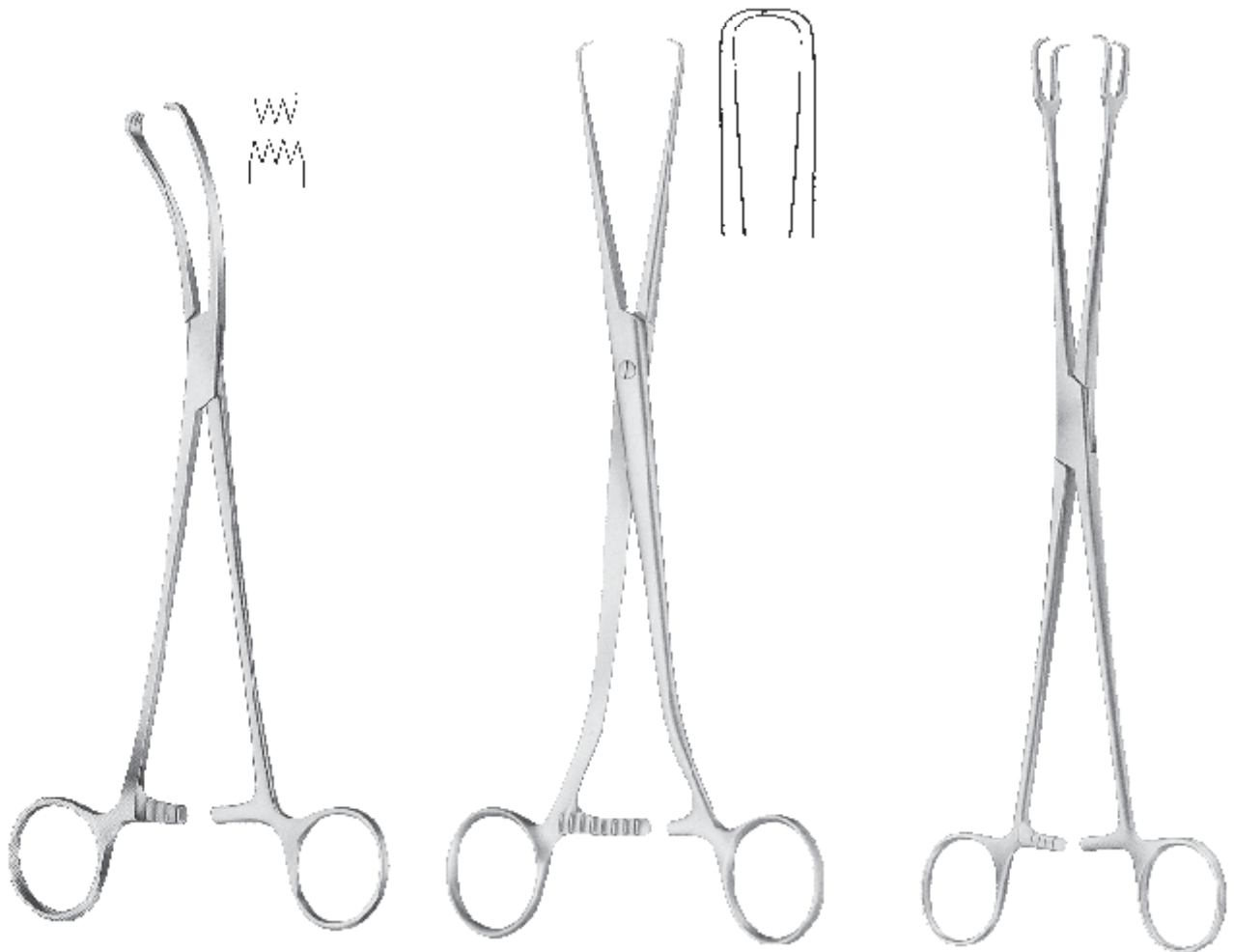

TEALE

O10-09509
 3 x 4 teeth
 230mm (9") Curved

O10-09510
 230mm (9") Straight

O10-09511
 180mm (7") Curved

ROTUNDA

O10-09512
 265mm (10.1/2")

SCHROEDER

O10-09513
 250mm (10")

TENACULUM FORCEPS



JACOBS
O11-09514
 215mm (8.1/2")

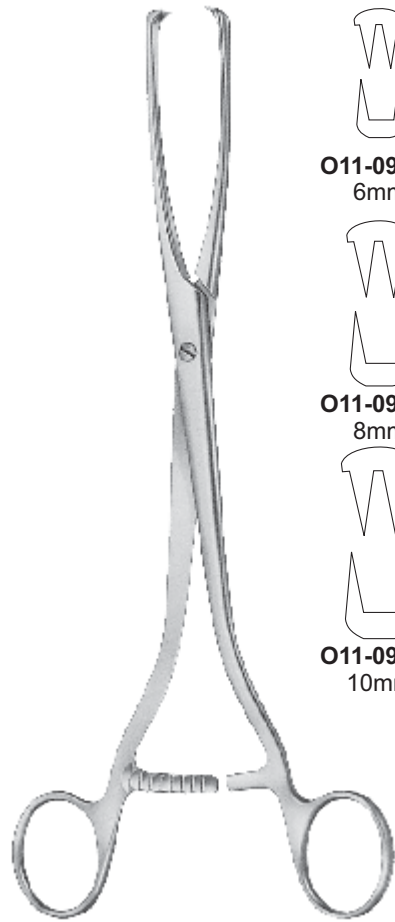

MUSEUX
 240mm (9.1/2")

O11-09515
 6mm

O11-09516
 8mm

O11-09517
 10mm

OVUM FORCEPS



HEYWOOD SMITH

O12-09518
 240mm (9.1/2")

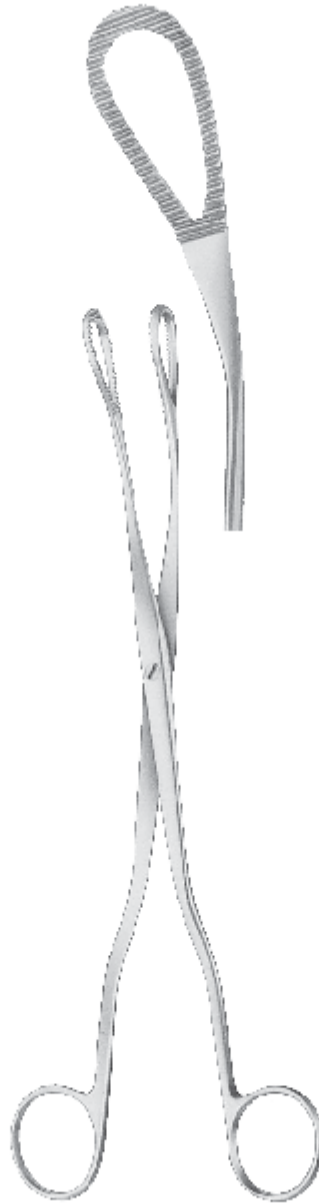

MCLINTOCK

O12-09519
 240mm (9.1/2")



NOTO

O12-09520
 280mm (11")



OVUM FORCEPS

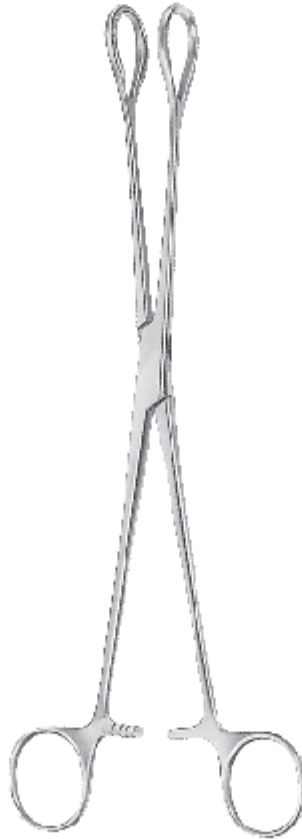
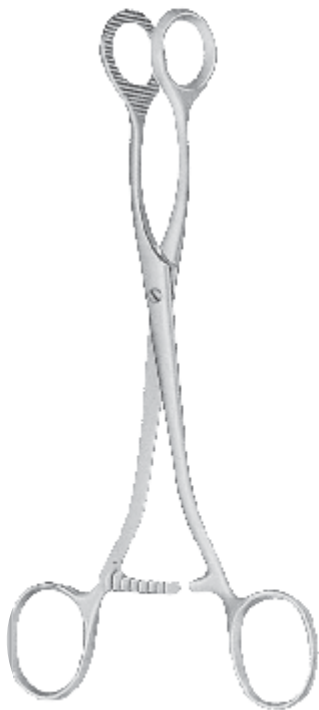
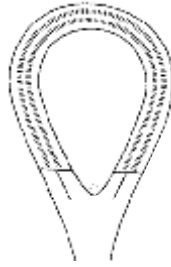

DOYEN

O13-09521
185mm (7.1/4")

O13-09522
250mm (10")

BONNEY POLYPI

O13-09523
240mm (9.1/2")



UTERINE ELEVATOR FORCEPS



SOMER

O14-09524
235mm (9.3/4")



DARTIGUES

O14-09525
255mm (10")



DOYEN

O15-09526
150mm (6")
Abdominal

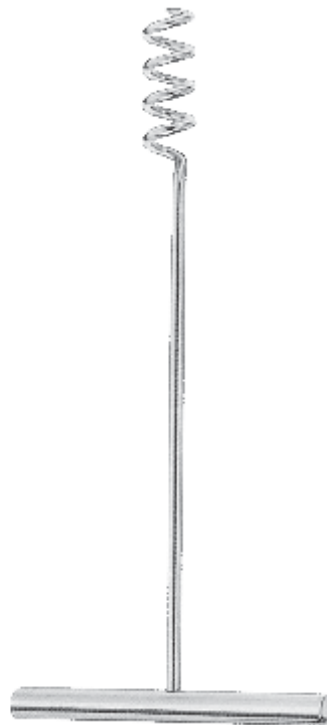

DOYEN

O15-09527
190mm (7.1/2")
Vaginal



**CERVICAL BIOPSY
 FORCEPS & CURETTES**



**ENDOMETRIAL
 BIOPSY CURETTE**

O16-09528
 240mm (9.1/2")



SHARMAN

O16-09529
 270mm (10.3/4")



THOMS-GAYLOR

O16-09530
 240mm (9.1/2")

CERVICAL BIOPSY FORCEPS

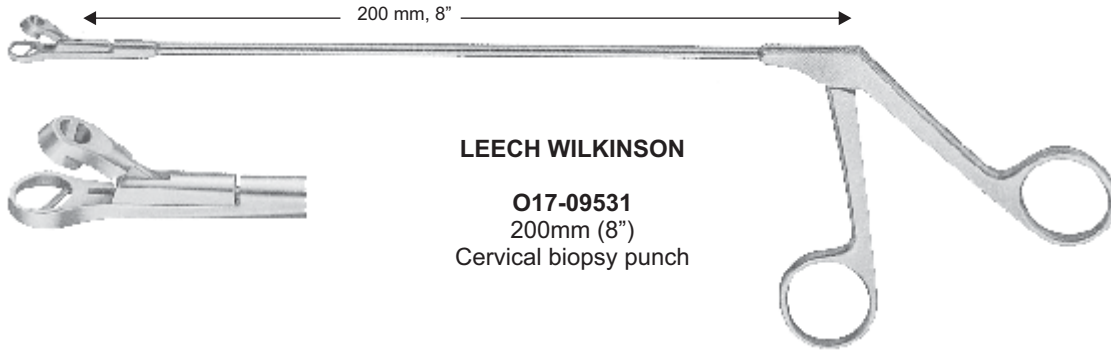

LEECH WILKINSON
O17-09531
 200mm (8")
 Cervical biopsy punch

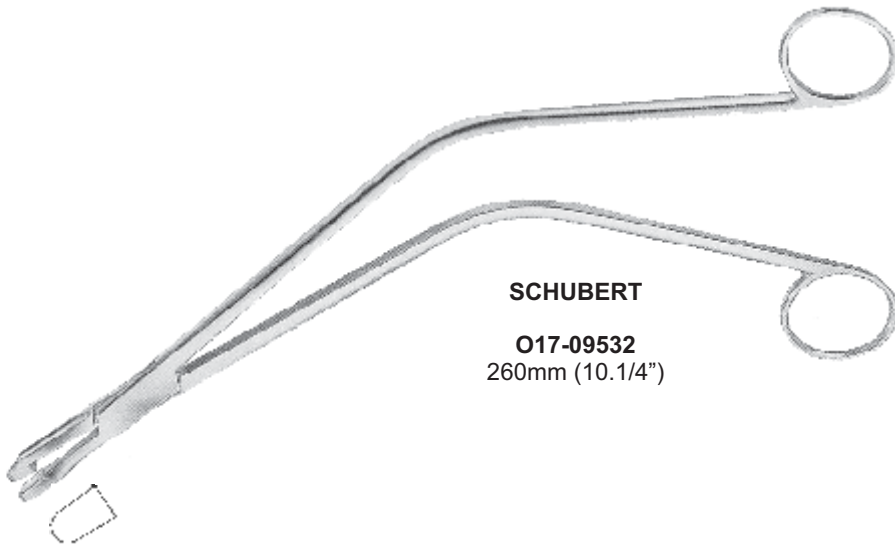

SCHUBERT
O17-09532
 260mm (10.1/4")

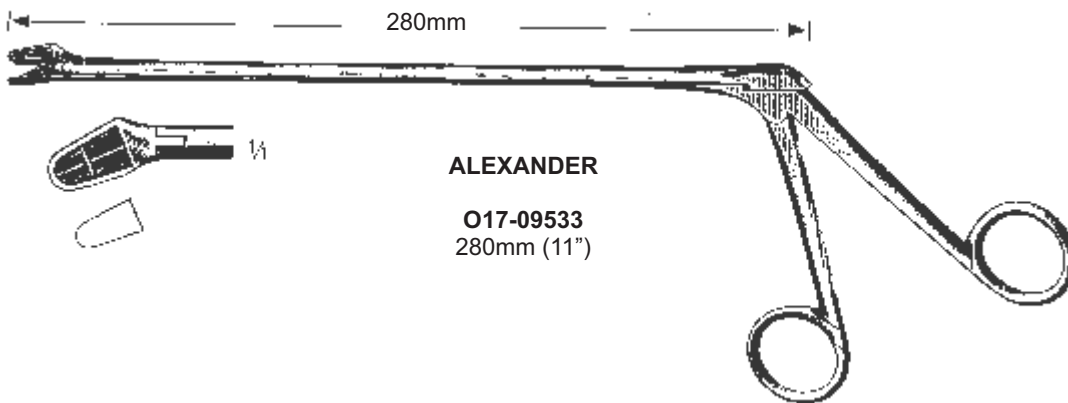

ALEXANDER
O17-09533
 280mm (11")

CERVICAL BIOPSY FORCEPS



240mm

SCHUMARCHER

O18-09534
 240mm (9.1/2")



235mm

KEVORKIAN

O18-09535
 235mm (9.3/4")



230mm

WITTNER

O18-09536
 230mm (9.1/4") Straight
 230mm (9.1/4") Curved

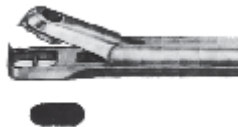

200mm

TISCHLER-MORGAN

O18-09537
 200mm (8")

CERVICAL BIOPSY FORCEPS



OVAL
 7 x 5 mm

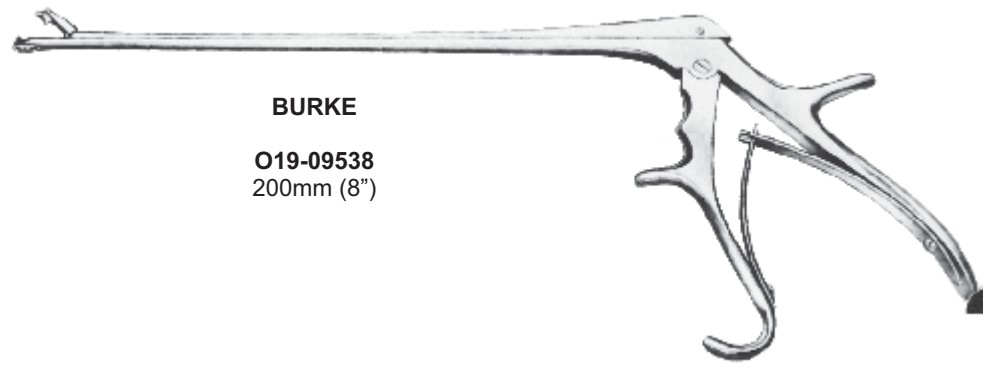

BURKE
 O19-09538
 200mm (8")



TISHLER-MORGAN

Fig.1

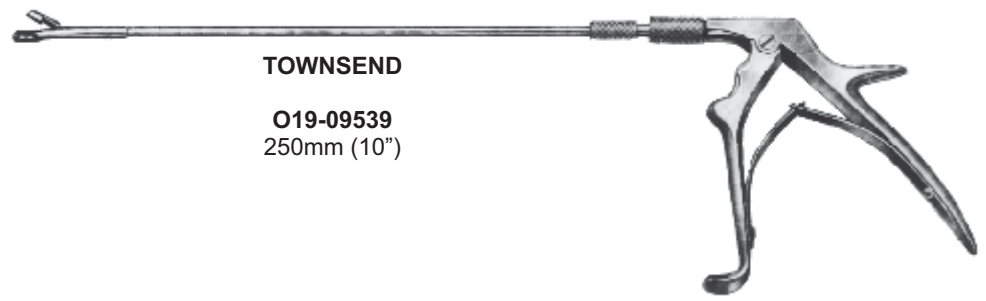

TOWNSEND
 O19-09539
 250mm (10")



OVAL
 3.7 x 5mm

Fig.3

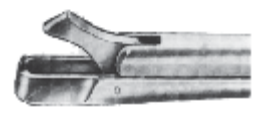

MINI

Fig.5



KEVORKIAN

Fig.4



3 x 8 mm

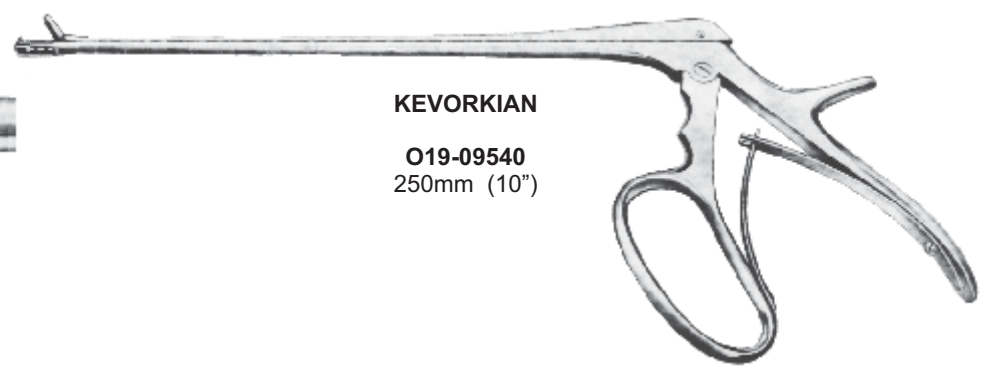

KEVORKIAN
 O19-09540
 250mm (10")

CERVICAL BIOPSY FORCEPS

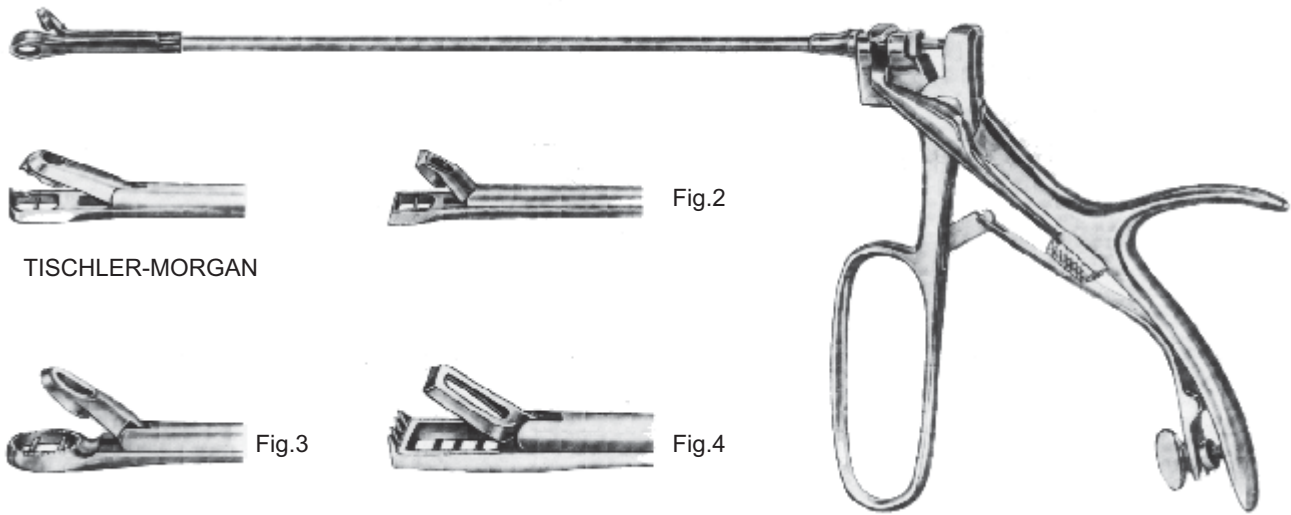

TISCHLER-MORGAN

Fig.2

Fig.3

Fig.4

EPPENDORFER

O20-09544
 230mm (8.1/2")

CERVICAL BIOPSY FORCEPS



O21-09545
 140mm (5.1/2")
 Pistol Grip



O21-09546
 140mm (5.1/2")
 Pistol grip



Shaft only
O21-09547 200mm (8")
O21-09548 250mm (10")

Biopsy cutting



O21-09549 ⊕
O21-09550 ⊕



O21-09551 ⊕



O21-09552 △

UTERINE SCOOPS AND CURETTES

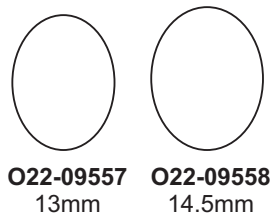
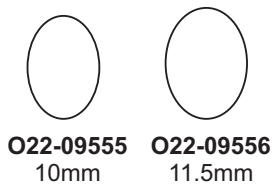

SIMON
 240mm (9.1/2")

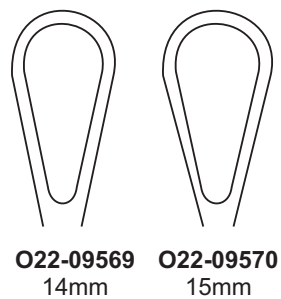
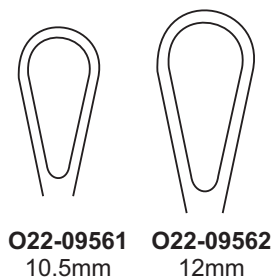

SIMS
 255mm (10")
 Rigid, sharp



SIMS
 255mm (10")
 Malleable, Sharp

UTERINE CURETTES



O23-09571
7.5mm



O23-09572
8.5mm





O23-09577
4.5mm



O23-09578
7.5mm

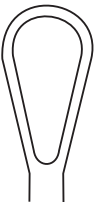

O23-09579
8.5mm

O23-09573
10.5mm



O23-09574
12mm

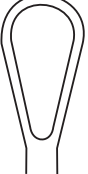

O23-09580
10.5mm

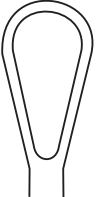

O23-09581
12mm



O23-09582
14mm

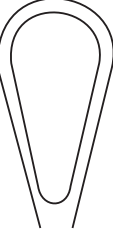

O23-09575
14mm

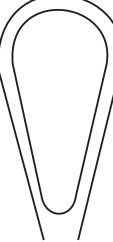

O23-09576
15mm

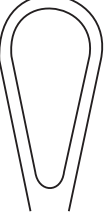

O23-09583
15mm

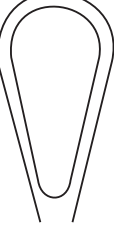

O23-09584
16.5mm

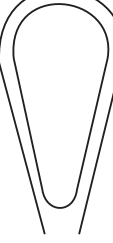

O23-09585
18mm

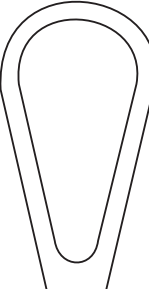
O23-09586
19.5mm

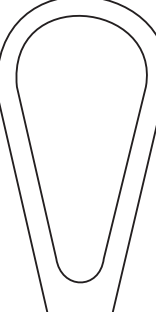

O23-09587
21.5mm

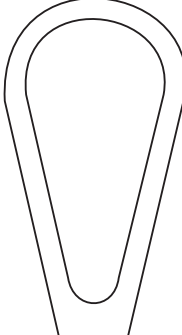

O23-09588
23.5mm

SIMS
255mm (10")
Malleable, blunt

300mm (12")
Sharp

UTERINE CURETTES



O24-09589
7.5mm



O24-09590
8.5mm

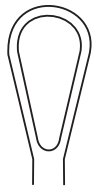

O24-09591
10.5mm



O24-09592
12mm



O24-09593
14mm



O24-09594
15mm

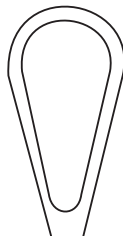

O24-09595
16.5mm

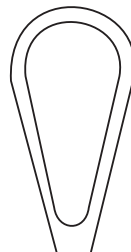

O24-09596
18mm

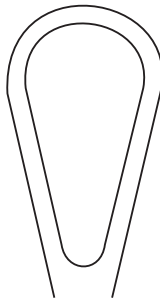

O24-09597
19.5mm

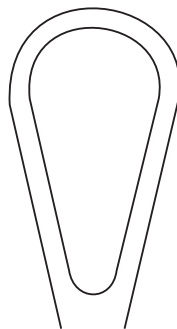

O24-09598
21.5mm

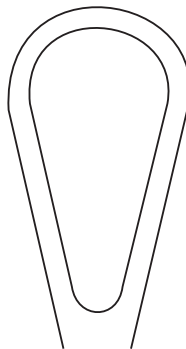

O24-09599
23.5mm



300mm (12")
Blunt



DOUBLE ENDED
250mm (9.3/4")
O24-09600 Sharp / blunt
O24-09601 Sharp / sharp



OBSTETRIC INSTRUMENTS



UTERINE FLUSHING TUBE

O25-09602
350mm (14")
Diameter: 10mm

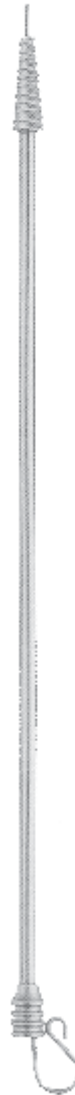

**LEECH-WILKINSON
INTRA-UTERINE CANNULA**

265mm (10.1/2")
With stilette



O25-09603
Small
Diameter 10 x 25mm



O25-09604
Medium
Diameter 13 x 30mm



O25-09605
Large
Diameter 16 x 30mm





**SPACKMANN
INTRA-UTERINE CANNULA**

O26-09606
360mm (14.1/4")
With adjustable plate for
vulsellum forceps





OBSTETRICS INSTRUMENTS



I.U.D. REMOVING HOOK

O27-09607
320mm (12.1/2")



WRIGLEY

O27-09608
250mm (10")



KIELLAND

O27-09609
402mm (16.3/4")



UTERINE CANNULAE



BARNES

O28-09610
 410mm (16")
 With Simpson handles and
 Neville axis traction rod

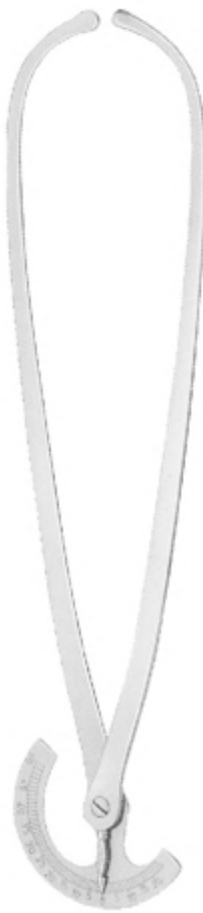

**FRENCH MODEL
 PELVIMETER**

O28-09611
 330mm (13")
 External and internal
 Graduated to 50 and
 22cms



**VACUME
 EXTRACTION
 SUCTION HEAD**

O28-09612 40mm
O28-09613 50mm
O28-09614 60mm



AMNIOTOME

O28-09615
 240mm (9.1/2")



UTERINE CANNULAE

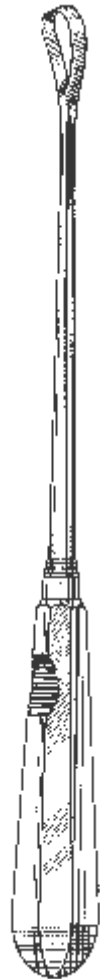
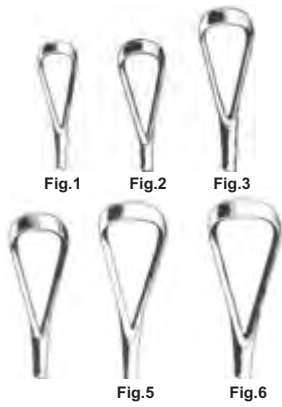

SIMS
O29-09616
 280mm (11")



RECAMIER
O29-09617
 310mm (13")



BUMM
O29-09618
 280mm (11")



OBSTETRIC INSTRUMENTS



SIMPSON

O30-09620
 300mm (12")

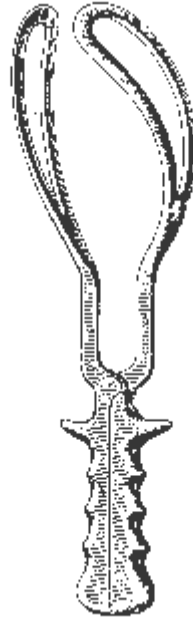

SIMPSON-BRAUN

O30-09621
 330mm (13")

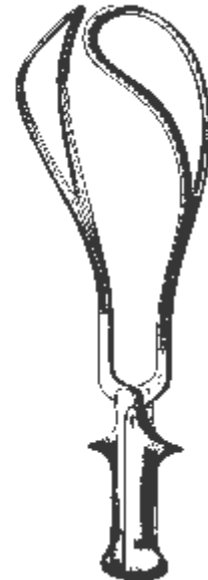

De LEE

O30-09622
 300mm (12")

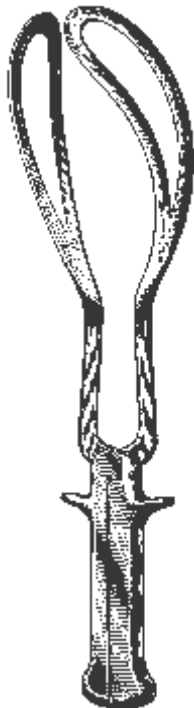

De LEE

O30-09623
 360mm (14.1/2")



ELLIOT

O30-09624
 320mm (12.1/2")

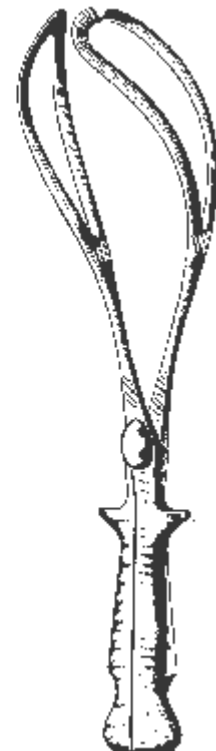

NAEGELE

O30-09625
 360mm (14.1/2")



OBSTETRICS INSTRUMENTS

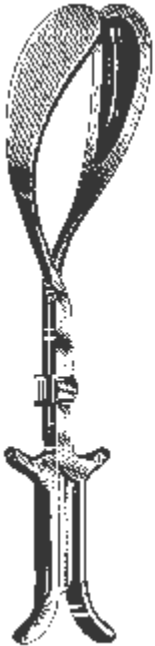

LUIKART

O31-09626
400mm (16")

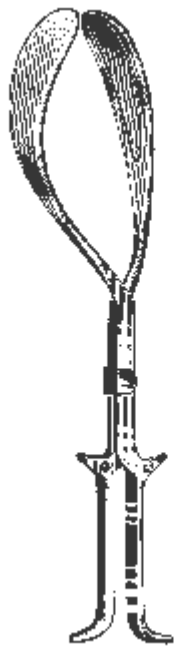

KIELLAND-LUIKART

O31-09627
400mm (16")

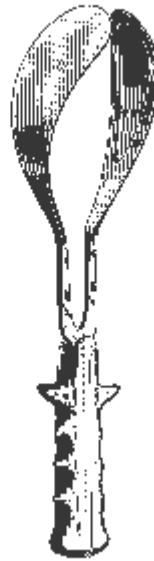

SIMPSON-LUIKART

O31-09628
360mm (14.1/2")



McLEAN-TUCKER-LUIKART

O31-09629
400mm (16")



McLEAN-TUCKER

O31-09630
390mm (15.1/2")

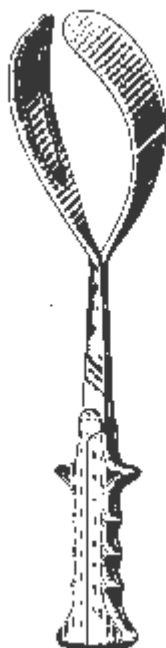

McLEAN-LUIKART

O31-09631
390mm (15.1/2")



McLEAN

O31-09632
360mm (14.1/2")

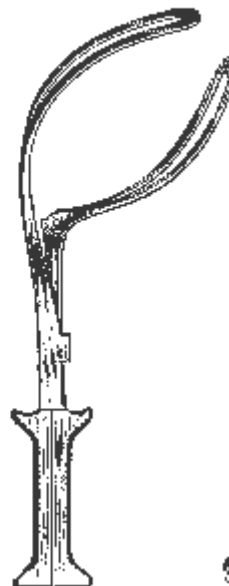

BARTON

O31-09633
360mm (14.1/2")

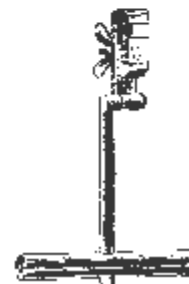

BARTON

O31-09634
170mm (6.3/4")



OBSTETRICS INSTRUMENTS

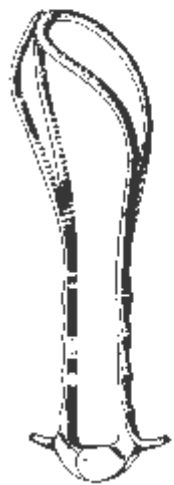

BOERMA
 O32-09635
 290mm (11.1/2")

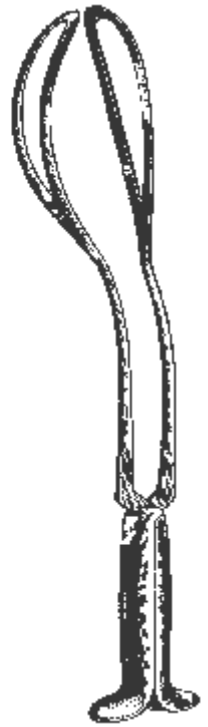

PIPER
 O32-09636
 440mm (17.1/2")

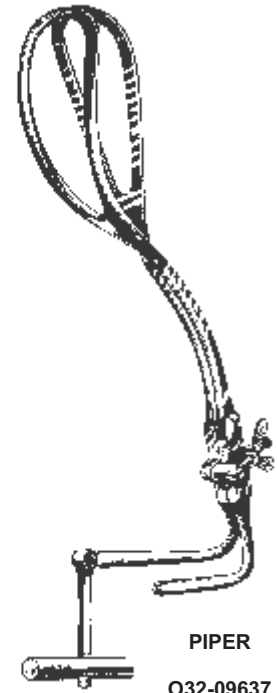

PIPER
 O32-09637
 400mm (16")

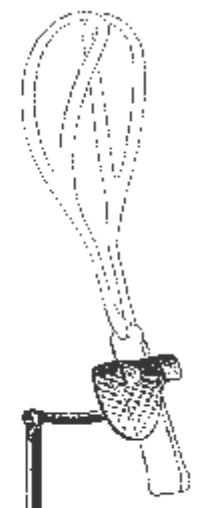

BILL
 O32-09640

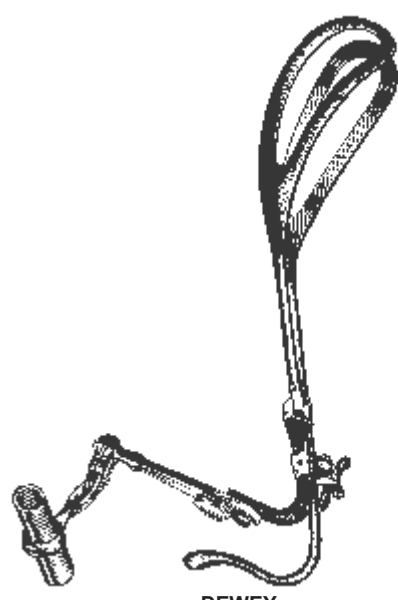

DEWEY
 O32-09638
 370mm (14.3/4")

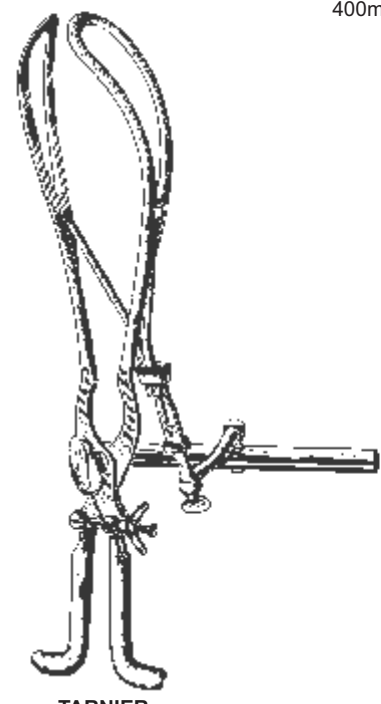

TARNIER
 O32-09639
 400mm (16")

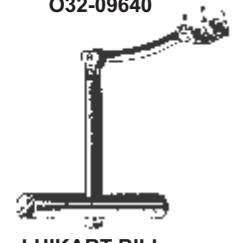

LUIKART-BILL
 O32-09641
 210mm (8.1/4")

**OBSTETRICS (MIDWIFERY)
 FORCEPS**

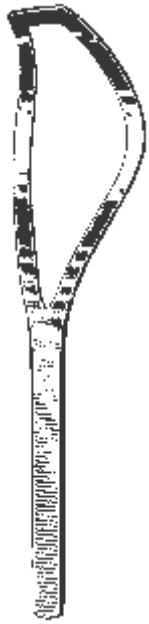

SELLHEIM
 O33-09642
 280mm (11")

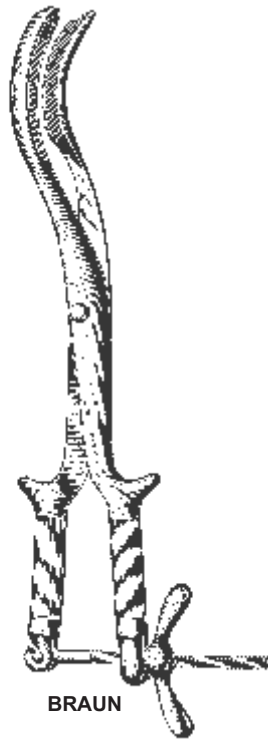

BRAUN
 O33-09643
 420mm (16.3/4")

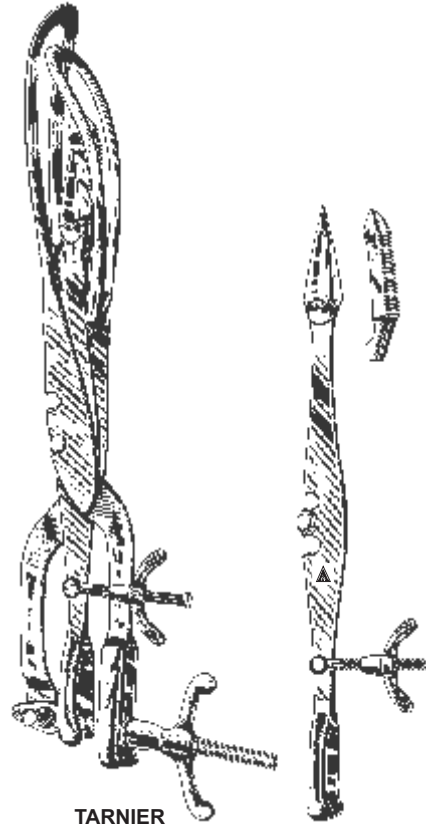

TARNIER
 O33-09644
 460(18.1/4")

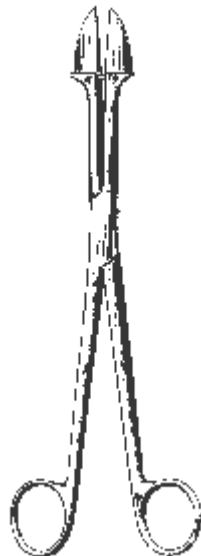

SPELLIE
 O33-09645
 250mm (10")



BRAUN
 O33-09646
 300mm (12")



KILNER
 O34-09647
 150mm (6")



SCHAMBERG
 O34-09648
 100mm (4")

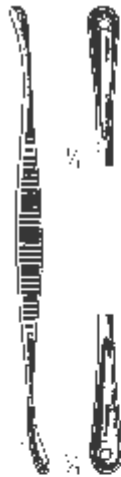

UNNA
 O34-09649
 140mm (5.1/2")



UNNA
 O34-09650
 140mm (5.1/2")



WALTON
 O34-09651
 140mm (5.1/2")



SAALFELD
 O34-09652
 100mm (4")



FOX
 O34-09653

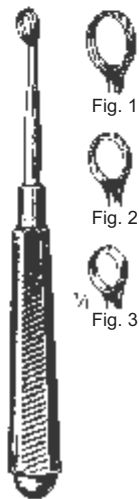

PIFFARD
 O34-09654



KEYES
 O34-09655
 Complete

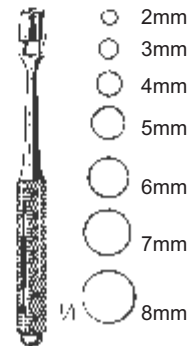

KEYES
 O34-09656

DERMATOLOGY INSTRUMENTS



**GREEN - ARMYTAGE
 HEAMOSTASIS FORCEPS**

O35-09657
 200mm (8") Straight

O35-09658
 195mm (7.3/4") Angled



WINTER OVUM FORCEPS
 290mm (11.1/2")



O35-09659



O35-09660



O35-09661



SAENGER OVUM FORCEPS

O36-09662
275mm (10.3/4")



UMBILICAL DILATOR

O36-09663
95mm (3.3/4")



PERITONEUM INSTRUMENTS



O37-09664



O37-09665



O37-09666



O37-09667



O37-09668



O37-09669



MIKULICZ
 O37-09664
 180mm (7")

O37-09665
 205mm (8")



PEROTONEUM
 O37-09666
 205mm (8")

O37-09667
 205mm (8")



FAURE
 O37-09668
 205mm (8")

O37-09669
 205mm (8")

HYSTERECTOMY CLAMPS



O38-09670



O38-09671



O38-09672



O38-09673



O38-09674



**GWILLIAM
 HYSTERECTOMY**
 200mm (8")

O38-09670
 Straight

O38-09671
 Curved



**HEANY
 HYSTERECTOMY FORCEPS**
 200m (8")

O38-09672
 Curved, single tooth



HEANY

O38-09673
 205mm (8")

O38-09674
 245cm (9.3/4")

HYSTERECTOMY CLAMPS



**MAINGOT
 GYSTERECTOMY FORCEPS**

O39-09675
 200mm (8")
 Curved, 1 x 2 teeth

O39-09676
 Straight, 1 x 2 teeth

O39-09677
 240mm (9.1/2")
 Curved, 1 x 2 teeth



PHANEUF

O39-09678
 205mm (8")
 Straight, 1 x 2 teeth



BONNEY

O39-09679
 205mm (8")
 Angled on flat, 1 x 2 teeth

HYSTERECTOMY CLAMPS

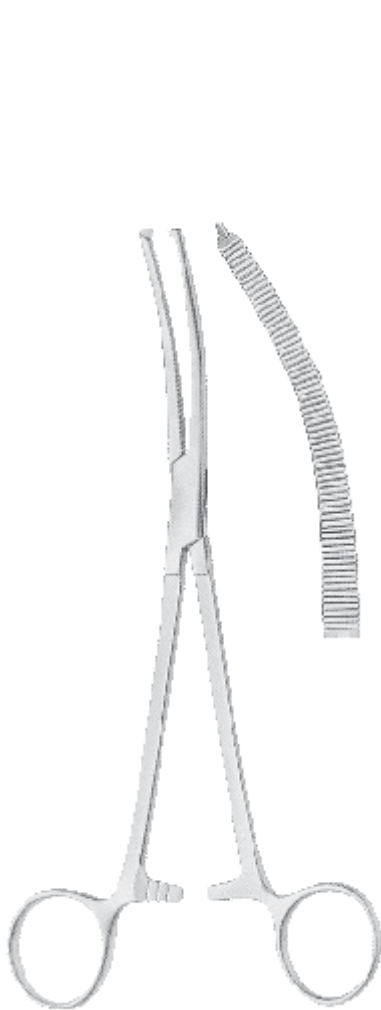

**BONNEY - BERKELEY
 HYSTERECTOMY FORCEPS**

O40-09680
 190mm (7.1/2")
 Curved on flat, 1 x 2 teeth

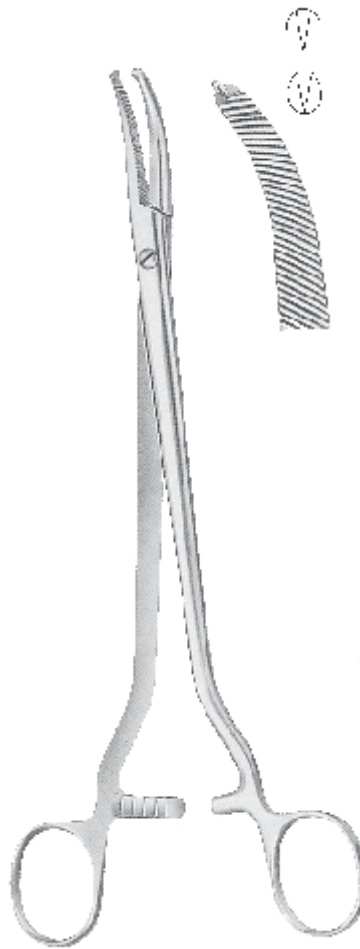

WERTHEIM

O40-09681
 235mm (9.1/4")



WERTHEIM

O40-09682
 245mm (9.3/4")

HYSTERECTOMY CLAMPS



O41-09683
 215mm
 (8.1/2")



O41-09684
 205mm
 (8")



O41-09685
 250mm
 (10")



O41-09686
 245mm
 (9.3/4")



**HYSTERECTOMY
 FORCEPS**
 Atraumatic



O41-09687
 220mm
 (8.3/4")



O41-09688
 240mm
 (9.1/2")



O41-09689
 225mm
 (9")



O41-09690
 230mm
 (9")



WERTHEIM

O42-09691
255mm (10")

PROCTOLOGY

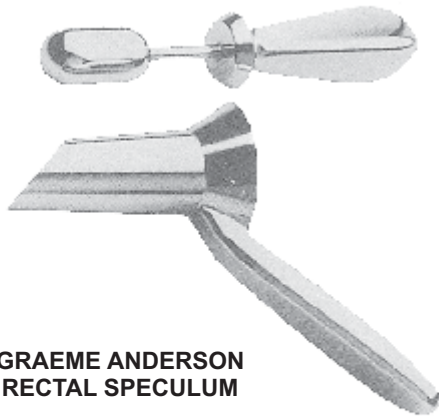

**GRAEME ANDERSON
 RECTAL SPECULUM**

O43-09700
 190mm (7.1/2")
 Diameter: 19mm

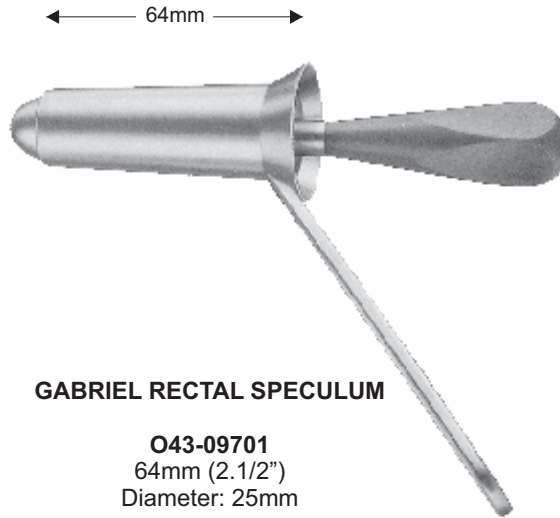

GABRIEL RECTAL SPECULUM

O43-09701
 64mm (2.1/2")
 Diameter: 25mm

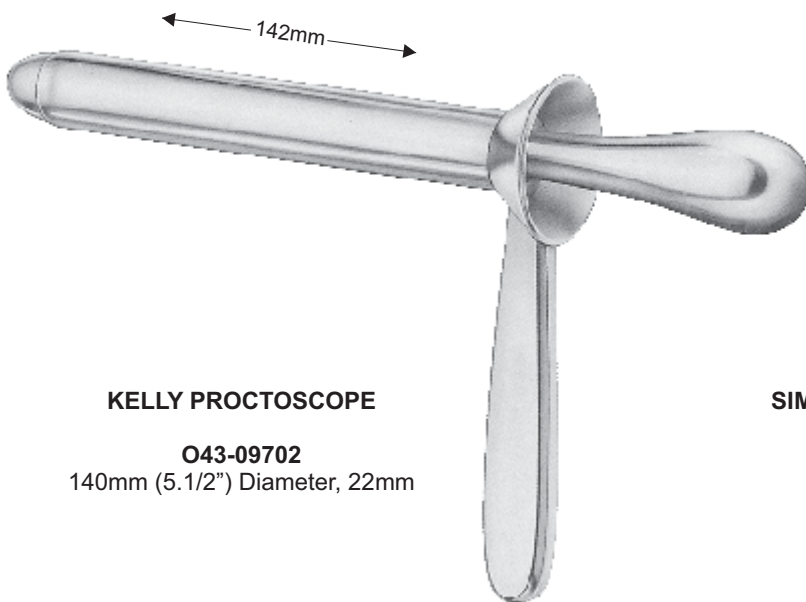

KELLY PROCTOSCOPE

O43-09702
 140mm (5.1/2") Diameter, 22mm



SIMS RECTAL SPECULUM

O43-09703
 160mm (6.1/4")

PROCTOLOGY

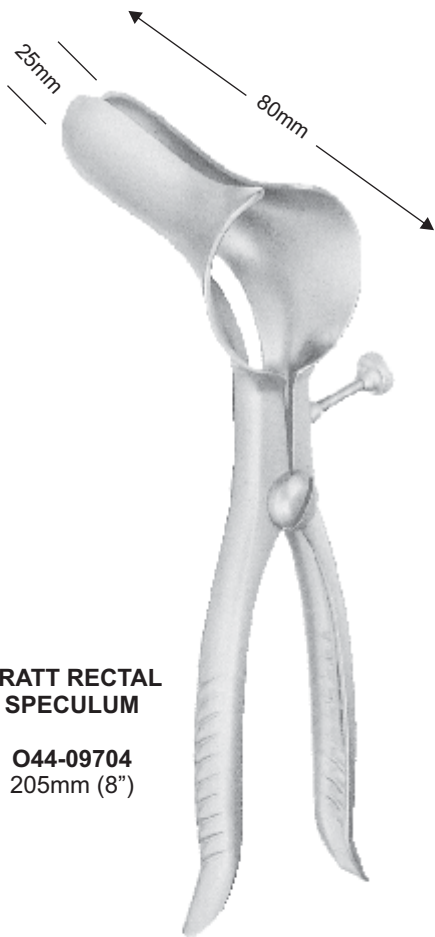

PRATT RECTAL SPECULUM

O44-09704
 205mm (8")

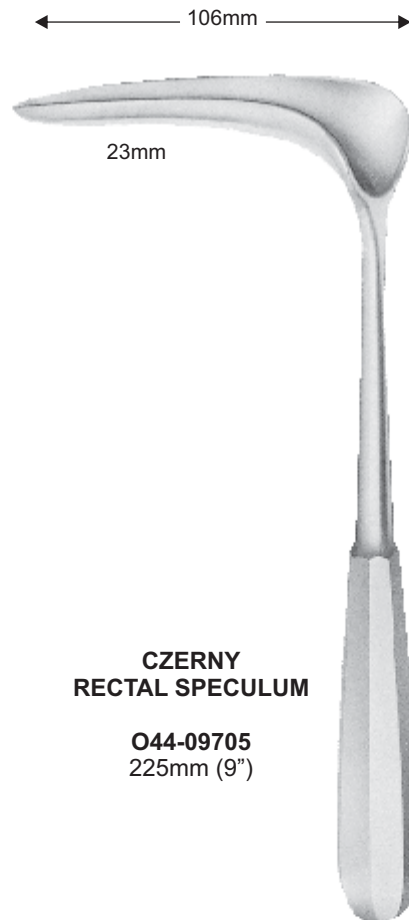

CZERNY RECTAL SPECULUM

O44-09705
 225mm (9")



MCEVEDY RECTAL SPECULUM WITH BATTERY HANDLE

O44-09706
 150mm (6") Diameter: 27mm

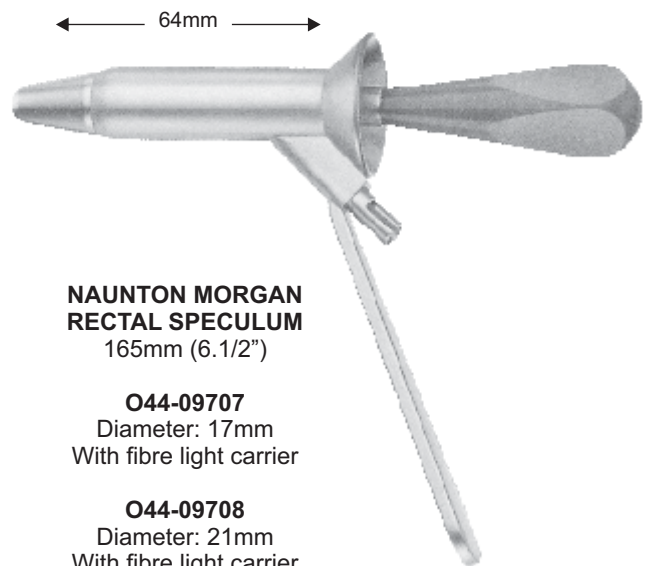

NAUNTON MORGAN RECTAL SPECULUM
 165mm (6.1/2")

O44-09707
 Diameter: 17mm
 With fibre light carrier

O44-09708
 Diameter: 21mm
 With fibre light carrier

O44-09709
 Diameter: 24mm
 With fibre light carrier



SIGMOIDOSCOPY

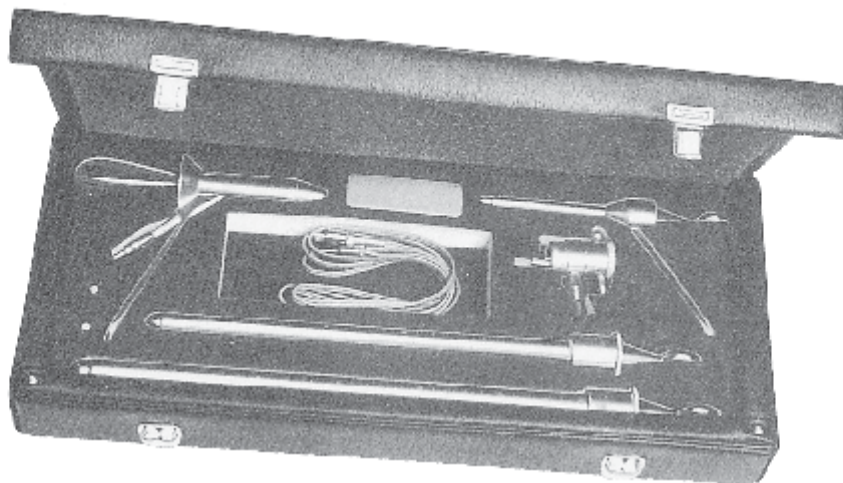

**LLOYD DAVIES (ST MARKS PATTERN)
MAJOR SIGMOIDOSCOPE AND
PROCTOSCOPE SET**

O45-09710

Set of consisting
Naunton Morgan Rectal Speculum (17mm)
Lloyd Davies Proctoscope (10mm)
Fibre light carrier
Lloyd Davies Sigmoidoscope (16mm)
Lloyd Davies Sigmoidoscope (20mm)
Case

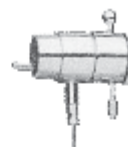

**LLOYD DAVIES (ST MARKS PATTERN)
COMBINATION SIGMOIDOSCOPE SET**

O45-09711
Consisting of
Fibre light carrier
Lloyd Davies Sigmoidoscope (16mm)
Lloyd Davies Sigmoidoscope (20mm)
Case



SIGMOIDOSCOPY

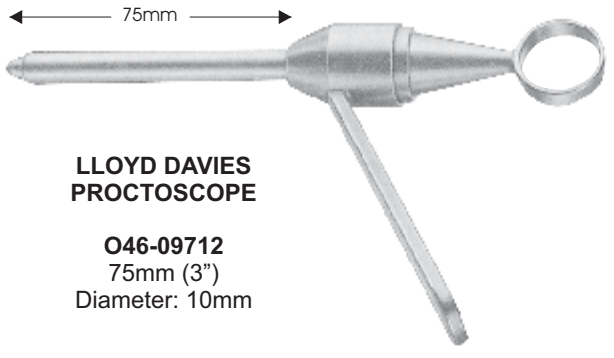

LLOYD DAVIES PROCTOSCOPE
O46-09712
 75mm (3")
 Diameter: 10mm

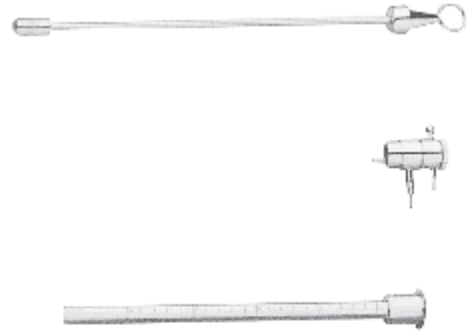

LLOYD DAVIES SIGMOIDOSCOPE

O46-09713
 Set consisting of
 Fibre light carrier
 Lloyd Davies Sigmoidoscope (16mm)



O46-09714
 250mm (9.3/4")
 Diameter: 16mm
 Sigmoidoscope only



O46-09715
 300mm (11.3/4")
 Diameter: 20mm
 Sigmoidoscope only

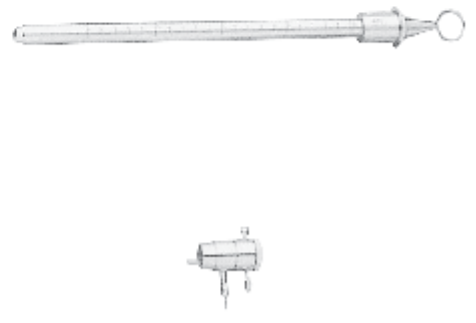

LLOYD DAVIES SIGMOIDOSCOPE

O46-09716
 Set consisting of
 Fibre light carrier
 Lloyd Davies Sigmoidoscope (20mm)

SIGMOIDOSCOPY / BIOSPY

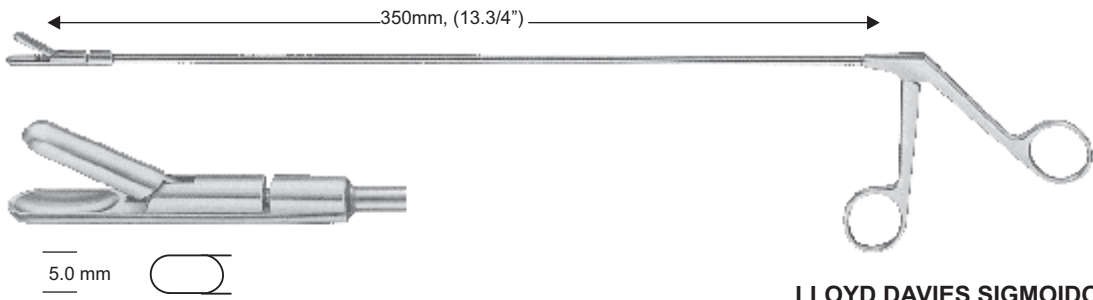

LLOYD DAVIES SIGMOIDOSCOPE BIOPSY FORCEPS

O47-09717
 350mm (13.3/4")

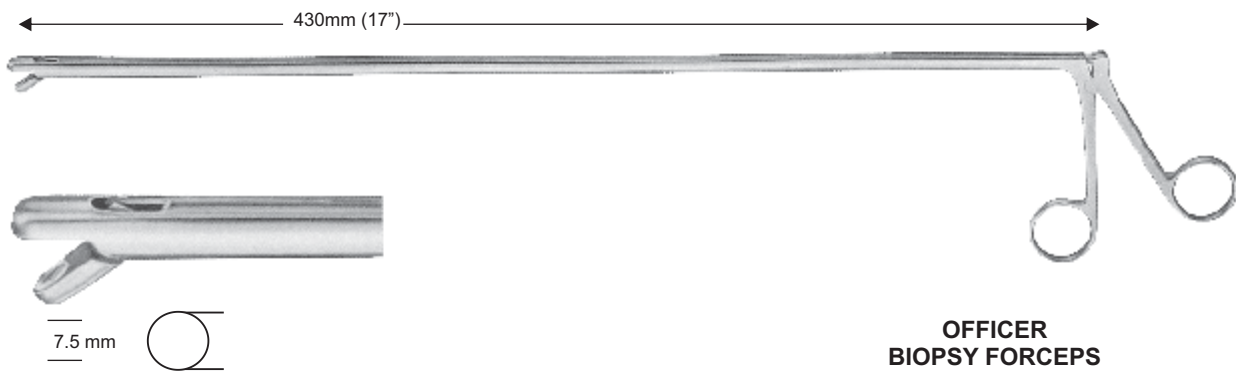

OFFICER BIOPSY FORCEPS

O47-09718
 430mm (17")
 Jaws 8mm

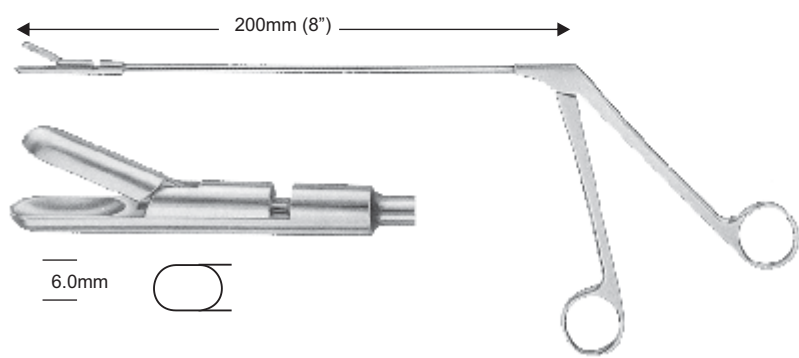

WALTON RECTAL BIOPSY FORCEPS

O47-09719
 200mm (8")
 Laterally angled shanks

**PROCTOLOGY HAEMORRHOIDAL
 IGATORS**

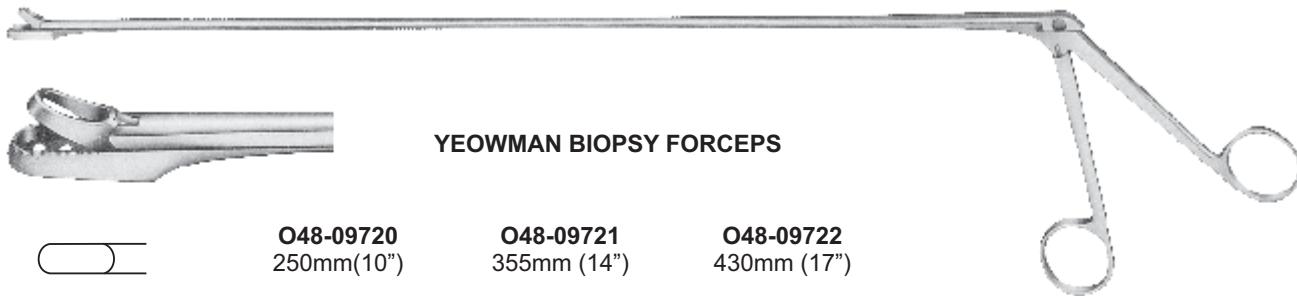

YEOWMAN BIOPSY FORCEPS



O48-09720
 250mm(10")

O48-09721
 355mm (14")

O48-09722
 430mm (17")

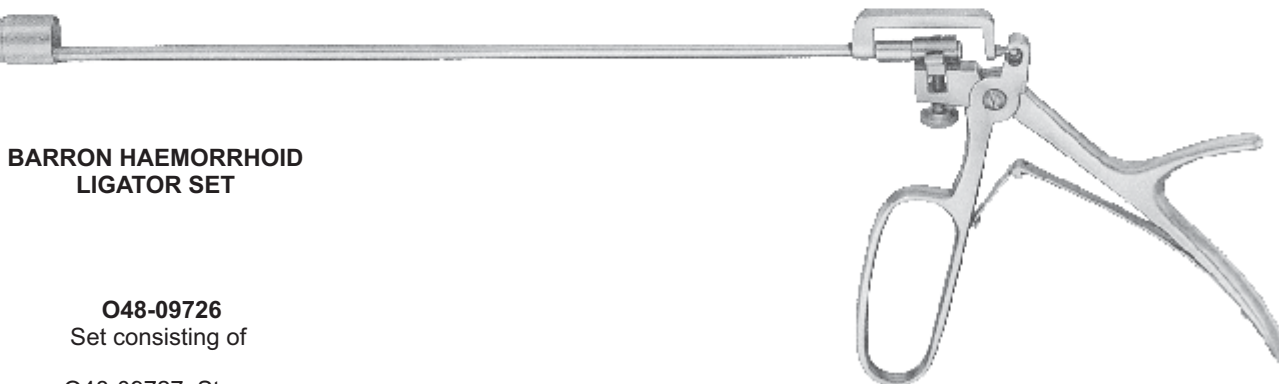

**BARRON HAEMORRHOID
 LIGATOR SET**

O48-09726
 Set consisting of

O48-09727 Stem
 O48-09728 "O" Ring
 O48-09729 Conical loader for
 "O" Ring

O48-09730 universal Handle

O48-09727
 215mm (8.1/2")
 Stem Only

O48-09728
 Pack of 300
 "O" Rings

O48-09729
 Conical loader only

O48-09730
 Universal handle

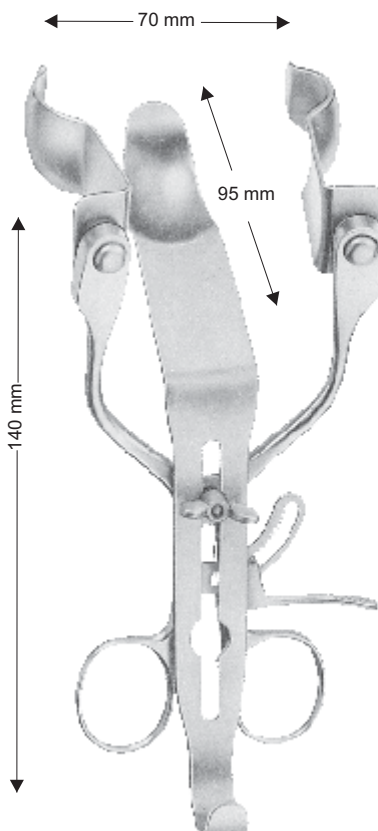

**PARK ANAL AND
 SPHINCTERECTOMY
 RETRACTOR**

O48-09723
 Complete with:
 Centre Blade: 95mm
 Pair Blades: 70mm AS-09724
 Pair Blades: 93mm AS-09725

O48-09724
 Spare Blades 70mm

O48-09725
 Spare Blades 93mm

HAEMORRHOIDAL LIGATORS

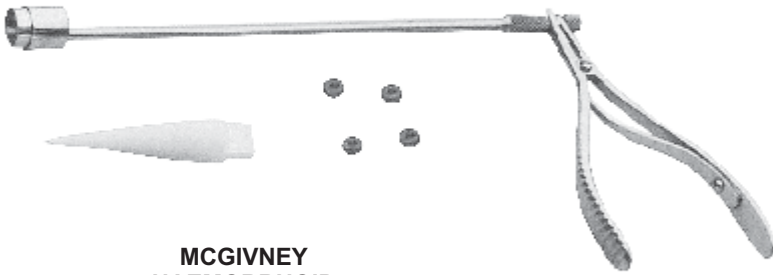

**MCGIVNEY
 HAEMORRHOID
 LIGATOR SET**

O49-09731
 Set consisting of:

- AS-09732 McGivney Ligator
- AS-09728 "O" Rings
- AS-09728 Conical loader for "O" rings

O49-09732
 McGivney ligator stem
 and handle only



**ST GEORGES SEIZING
 FORCEPS**

O49-09735
 195mm (7.3/4")
 To pass through applying drum
 of Barron Ligator

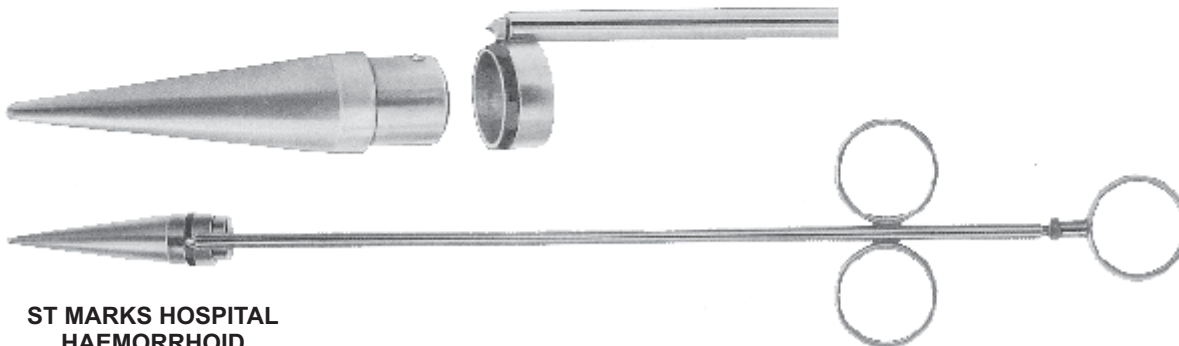

**ST MARKS HOSPITAL
 HAEMORRHOID
 LIGATOR SET**

O49-09733

- Set consisting of
- AS-09734 Ligator stem
 - AS-09728 "O" Rings
 - AS-09729 Conical loader for "O" rings

O49-09734
 270mm (10.1/2")
 Stem only

HAEMORRHOIDAL SYRINGES



GABRIEL METAL AND GLASS SYRINGE SET

Consisting of

- O50-09738** Gabriel needle, straight
- O50-09739** Gabriel needle, angled
- O50-09741** Gabriel syringe, 10ml

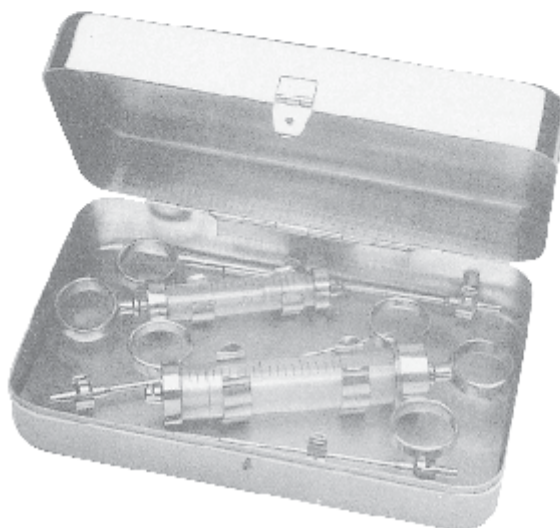

GABRIEL METAL AND GLASS SYRINGE SET

- O50-09737** Gabriel needle, straight
- O50-09738** Gabriel needle, straight
- O50-09739** Gabriel needle, angled
- O50-09740** Gabriel syringe, 3ml
- O50-09741** Gabriel syringe, 10ml



GABRIEL NEEDLES

Diameter: 0.9mm

- O50-09737**
75mm (3")
Straight

- O50-09738**
100mm (4")
straight

- O50-09739**
100mm (4")
Angled

GABRIEL SYRINGES

- O50-09740**
3ml

- O50-09741**
10ml

UROLOGY

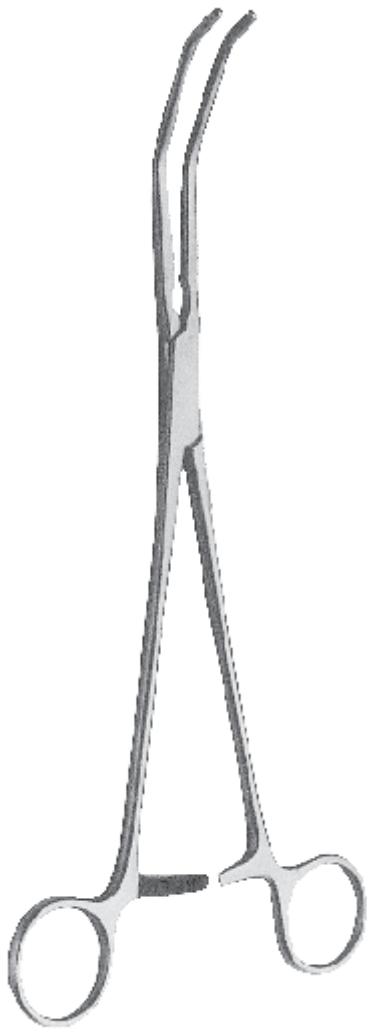

HERRICK
O51-09800
225mm (9")



GUYON
O51-09801
265mm (10.1/2")



KIDNEY CLAMP
O51-09802
255mm (10")

UROLOGY



RANDALL
 Renal Calculus Forceps

O52-09803
 A
 230mm (9")



O52-09804
 B
 200mm (8")



O52-09805
 C
 195mm (7.3/4")



O52-09806
 D
 180mm (7")



BLADDER SPATULA

O52-09807
 235mm (9.3/4")
 Blade: 91mm x 61mm



MILLIN

O52-09808
 245mm (9.3/4")
 Ligature holding forceps



UROLOGY



MILLIN

O53-09809
235mm (9.1/4")
Lobe grasping forceps



MILLIN

O53-09810
245mm (9.3/4")
Lobe grasping forceps



MILLIN

O53-09811
240mm (9.1/2")
Bladder neck spreader



**CUNNINGHAM
PENILE CLAMPS**
With foam rubber lining

O53-09812
Small

O53-09813
Medium

O53-09814
Large



**THOMPSON-WALKER
PENILE CLAMP**

O53-09815
115mm (4.1/2")



PENILE CLAMP

O53-09817
130mm (5.1/8")

MOULDED RUBBER SHEATHS

O53-09816
For use with AS-09815



**TURNER - WARWICK
 POSTERIOR DILATING
 URETHRAL SPECULUM**

O54-09818

Black finish except for internal surfaces of blades, self retaining with fibre light carrier 225mm (8.3/4")

O54-09819

Retractor without fibre light carrier

O54-09820

Fibre light carrier only

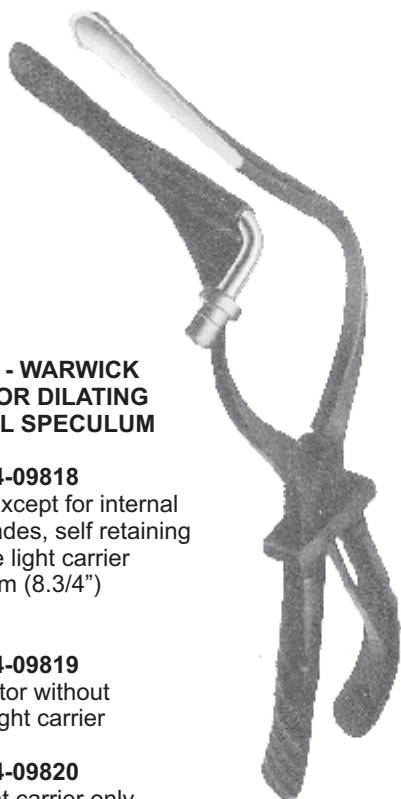

O54-09821
 30 degree No1



O54-09822
 70 degree No 2



O54-09823
 90 degree No 3

**TURNER-WARWICK
 POSTERIOR URETHRAL SUTURE NEEDLES**

O54-09824

Set of three comprising of:
O54-09821 30 degree curve
O54-09822 70 degree curve
O54-09823 90 degree curve
 200mm (8")
 Black finish except for 8mm of tip

UROLOGY



O55-09826
Double ended
4/9 f.g and 7/12 f.g
1.33/3mm and 2.33/4mm



O55-09827
Double ended
10/15 f.g and 13/18 f.g
3.33/5mm and 4.33/6mm



O55-09828
Double ended
16/21 f.g and 19/24 f.g
5.33/7mm and 6.33/8mm



O55-09829
Double ended
22/27 f.g and 25/30 f.g
7.33/9mm and 8.33/10mm

**TURNER - WARWICK METAL
DILATORS
O55-09825**

Set of comprising of:

- 1 x O55-09826
- 1 x O55-09827
- 1 x O55-09828
- 1 x O55-09829
- 1 x O55-09830



O55-09830
Double ended
28/33 f.g and 31/36 f.g

UROLOGY



**TURNER WARWICK (HEY GROVES)
 URETHRAL STAFF**

O56-09831
 Black finish 180mm (7")



**TURNER WARWICK
 DISSECTING SCISSORS**

Curved, with insulation shanks
 and universal diathermy
 attachment

O56-09832
 145mm (5.3/4")

O56-09833
 180mm (7")

O56-09834
 230mm (9")



**TURNER WARWICK
 NEEDLE HOLDER**

O56-09835
 Straight, right hand model,
 black finish 215mm (8.1/2")

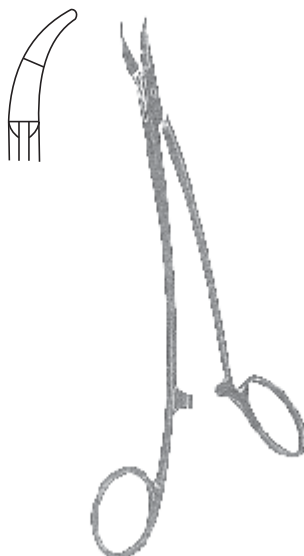

**TURNER WARWICK
 NEEDLE HOLDER**

O56-09836
 Curved, right hand model,
 black finish 215mm (8.1/2")

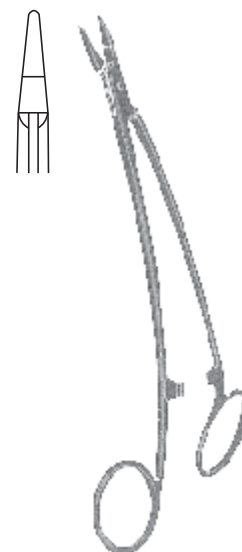

**TURNER WARWICK
 NEEDLE HOLDER**

O56-09837
 Straight, left hand model,
 black finish 215mm (8.1/2")



UROLOGY



**TURNER WARWICK
NEEDLE HOLDER**

O57-09838
Curved, right hand model,
black finish 215mm (8.1/2")

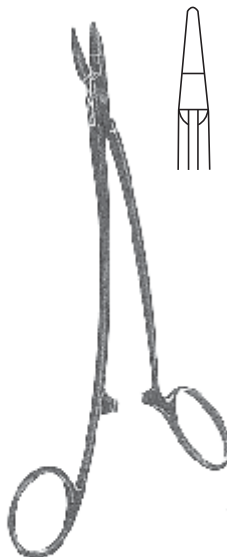

**TURNER WARWICK
NEEDLE HOLDER**

O57-09839
Straight, wide jaws
black finish 215mm (8.1/2")



**TURNER WARWICK
POST URETHROPLASTY
REVIEW SPECULUM**

O57-09840
135mm (5.1/2")
Black finish except for internal surface
of blades, self retaining, fitted with
fibre light speculum

O57-09841
Speculum only without fibre light

O57-09842
Fibre light carrier only



CLUTTON URETHRAL SOUNDS

265mm (10.1/2")

Set twelve **O58-09843**

Set Comprising one of each of:

- O58-09844** 6/10 f.g (2/3.33mm)
- O58-09845** 8/12 f.g (2.66/4.66mm)
- O58-09846** 10/14 f.g (3.33/4.66mm)
- O58-09847** 12/16 f.g (4/5.33mm)
- O58-09848** 14/18 f.g (4.66/6mm)
- O58-09849** 16/20 f.g (5.33/6.66mm)
- O58-09850** 18/22 f.g (6/7.33mm)
- O58-09851** 20/24 f.g (6.66/8mm)
- O58-09852** 22/26 f.g (7.33/8.66mm)
- O58-09853** 24/28 f.g (8/9.33mm)
- O58-09854** 26/30 f.g (8.66/33mm)
- O58-09855** 28/32 f.g (9.33/10.66mm)



O58-09856
 12 f.g (4mm)

O58-09857
 8 f.g (2.66mm)

O58-09858
 10 f.g (3.33mm)

O58-09859
 14 f.g. (4.66mm)

O58-09860
 16 f.g. (5.33mm)



FEMALE CATHETERS
 160mm (6.1/4")



SUCTION TUBES



POOLE

O59-09902
 240mm (9.1/2")

O59-09903
 180mm (7")
 Lawrie extension piece



YANKAUER

O59-09900
 305mm (12")

O59-09901
 Rose end



O59-09904

GILLIES
 170mm (6.3/4")
 Control valve

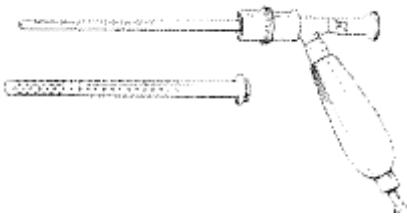

**TINCKLER
 (SIMPSON SMITH)**

O59-09905
 255mm (10")
 With on / off value, removable perforated outer sheath

SUCTION TUBES

FRAZIER

O60-09906
 185mm (7.1/4") Diameter 2.33mm 7.f.g

O60-09907
 185mm (7.1/4") Diameter 2.66mm 8 f.g

O60-09908
 185mm (7.1/4") Diameter 3mm 9.f.g



ADSON FRAZIER

180mm (7")

- O60-09909** Diameter 2mm
- O60-09910** Diameter 2.5mm
- O60-09911** Diameter 3mm
- O60-09912** Diameter 4mm
- O60-09913** Diameter 5mm



ADSON

180mm (7")

- O60-09914** Diameter 3mm
- O60-09915** Diameter 5mm



CONE SUCTION TUBES

O60-09916

Set comprising of one of each of the following items except **AS-09920**

SUCTION TUBES

- O60-09917** Diameter: 3mm
- O60-09918** Diameter: 4mm
- O60-09919** Diameter: 5mm



HANDLE

O60-09920 100mm (4")
 with Tucker valve



SUCTION TUBES



BARRON

O61-09921
230mm (9")
Diameter: 1.33mm



BELUCCI

O61-09922

Set comprising of each of the following items:

BELUCCI SUCTION TUBE

O61-09923

170mm (6.3/4") Diameter: 2mm



ZOELLNER DETACHABLE ENDS

O61-09924 20 s.w.g

O61-09925 22 s.w.g

O61-09926 24 s.w.g

FORMBY

O61-09927

210mm (8.1/4")
Diameter: 3.3mm



HOUSE

Shaft: 90mm (3.1/2")
Suction and irrigation tube

O61-09928

Diameter suction tube: 0.9mm
Diameter irrigating tube: 0.7mm

O61-09929

Diameter suction tube: 1.2mm
Diameter irrigating tube: 0.9mm

O61-09930

Diameter suction tube: 1.5mm
Diameter irrigating tube: 1.2mm



SUCTION TUBES

MAGILL
 210mm (8.1/4")

O62-09931
 Diameter: 3mm

O62-09932
 Diameter: 3.5mm

O62-09933
 Diameter: 4mm

O62-09934
 Stilette



SELF CLEARING
 230mm (9")

O62-09935
 Diameter: 1.5mm

O62-09936
 Diameter: 2mm

O62-09937
 Diameter: 3mm

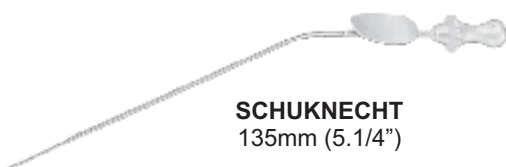

SCHUKNECHT
 135mm (5.1/4")

O62-09938
 20 s.w.g

O62-09939
 24 s.w.g



VERHOEVEN

O62-09941

Set comprising of one of each of the following items except AS-09940:

VERHOEVEN SUCTION TUBES

100mm (4")

O62-09942 16 s.w.g

O62-09943 18 s.w.g

O62-09944 20 s.w.g

O62-09945 22 s.w.g

O62-09946 24 s.w.g

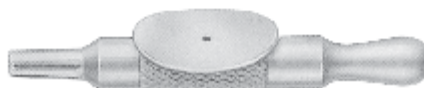

HOUSE ADAPTORT

O62-09940
 38mm (1.1/2")

For use with Verhoeven Suction Tubes

SUCTION TUBES

ZOELLNER

O63-09947
 180mm (7")



**ZOELLNER
 DETACHABLE ENDS**

O63-09948
 18 s.w.g.

O63-09949
 20 s.w.g.

O63-09950
 22 s.w.g.

O63-09951
 24 s.w.g.

O63-09952
 26 s.w.g.



ROWBOTHAM

O63-09953
 285mm (11.1/4")



CHIP SYRINGE

O63-09954
 For administering antibiotic powder

O63-09955
 Abrahams Pleural biopsy punch
 4mm diameter



LISTON

P1-10000
 Blade: 130mm (5.1/8")

P1-10001
 Blade 220mm (8.3/4")



LANGENBECK

P1-10002
 Resection knife



**BLAKE AMUPTATION FLAP
 RETRACTOR**

P1-10003
 Diameter: 240mm (9.1/2")

AMPUTATION INSTRUMENTS



PERCY AMPUTATION FLAP RETRACTOR

P2-10004
 Removable handles

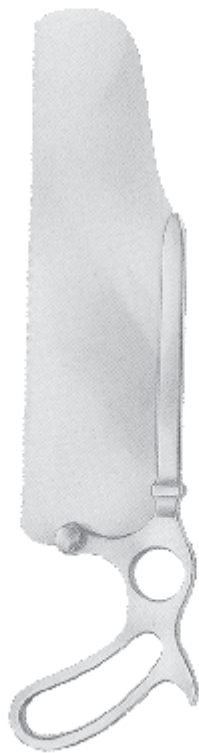

AMPUTATION SAW

With hinged back to take apart
P2-10005
 Blade: 230mm (9")

P2-10006
 Spare blade for amputation saw



FINGER SAW

P2-10007
 200mm (8")

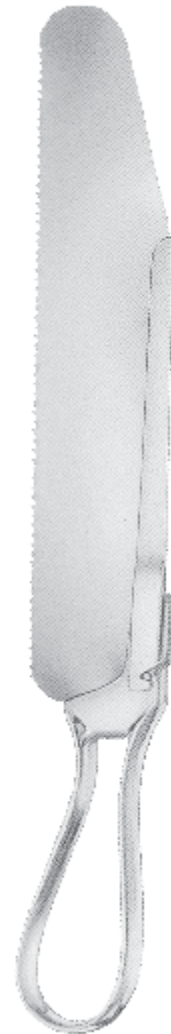

ARMY REGULATION AMPUTATION SAW

P2-10008
 Blade: 180mm (7")
 With hinged back to take apart

BONE LEVERS & ELEVATORS



ST THOMAS

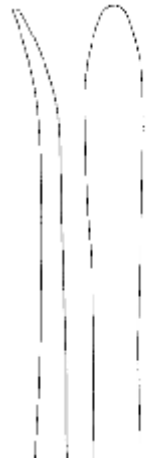

P3-11000
 180mm (7")
 Pointed end



P3-11001
 180mm (7")
 Rounded end

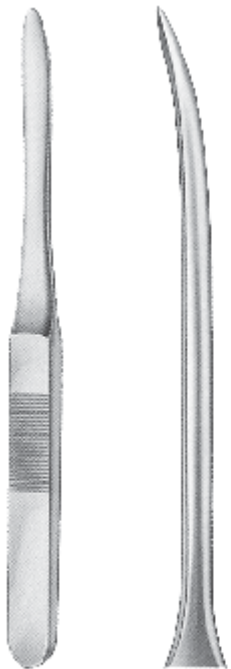

**CAIRNS SKULL FLAP
 ELEVATOR**

P3-11002
 180mm (7")



**TRETHOWAN
 BONE LEVER**

P3-11003
 215mm (8.1/2")

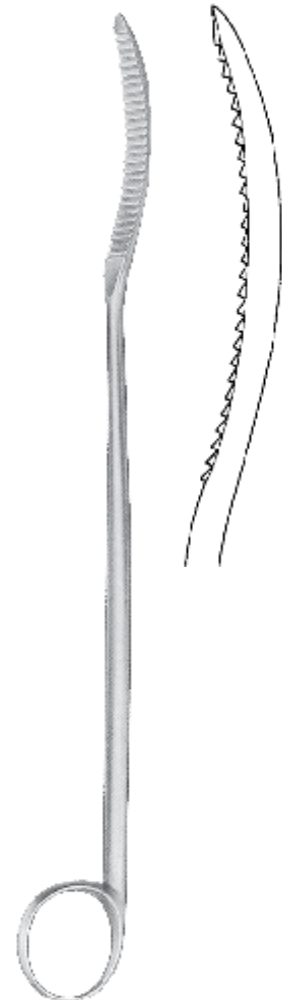

**LANE
 BONE LEVER**

P3-11004
 255mm (10")

BONE LEVERS



**WATSON JONES
 BONE LEVER**

P4-11005
 280mm (11")



P4-11006

P4-11006
 265mm (10.1/2")

P4-11007
 280mm (11.1/2")

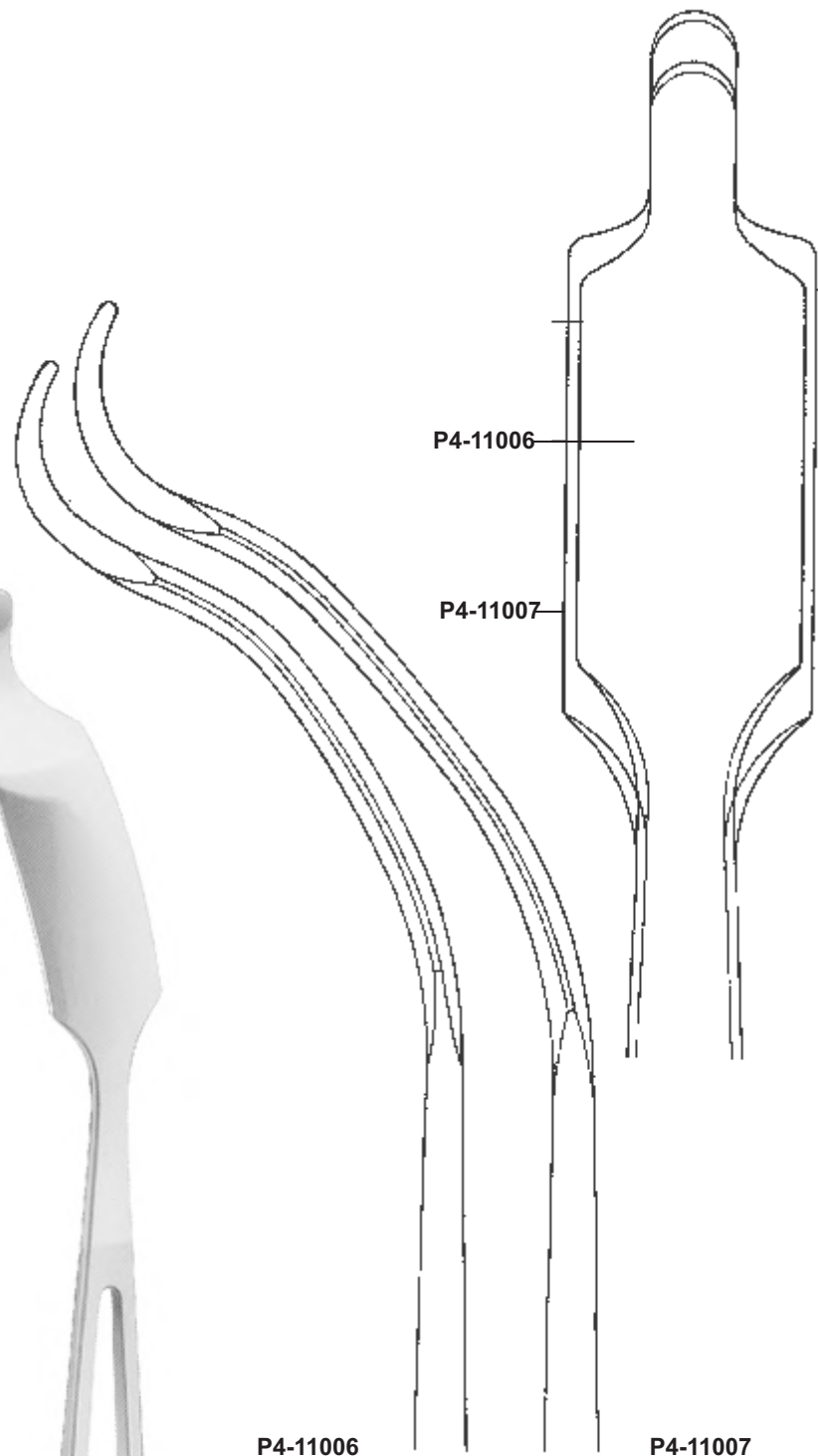

P4-11007

■ ■ ■ ■ ■

BONE LEVERS

■ ■ ■ ■ ■



HOHMANN
P5-11008
 220mm (8.3/4")
 Max width: 10mm

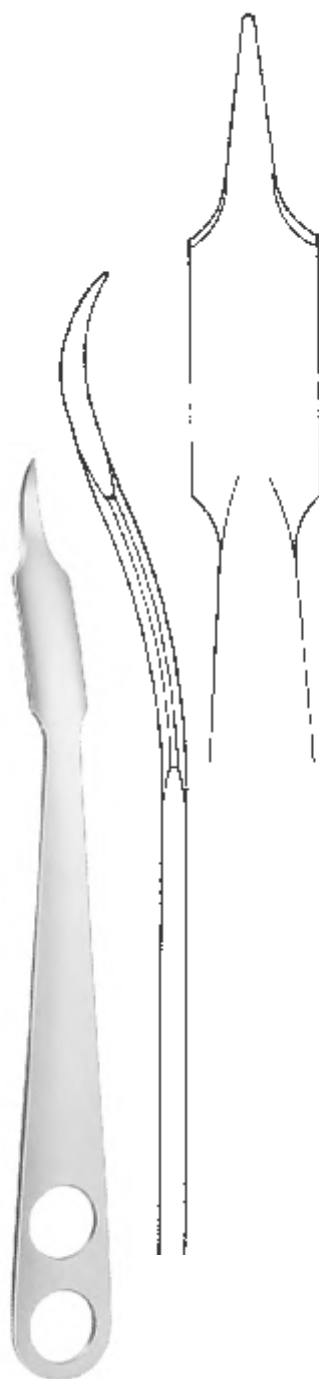

HOHMANN
P5-11009
 240mm (9.1/2")
 Max width: 17mm

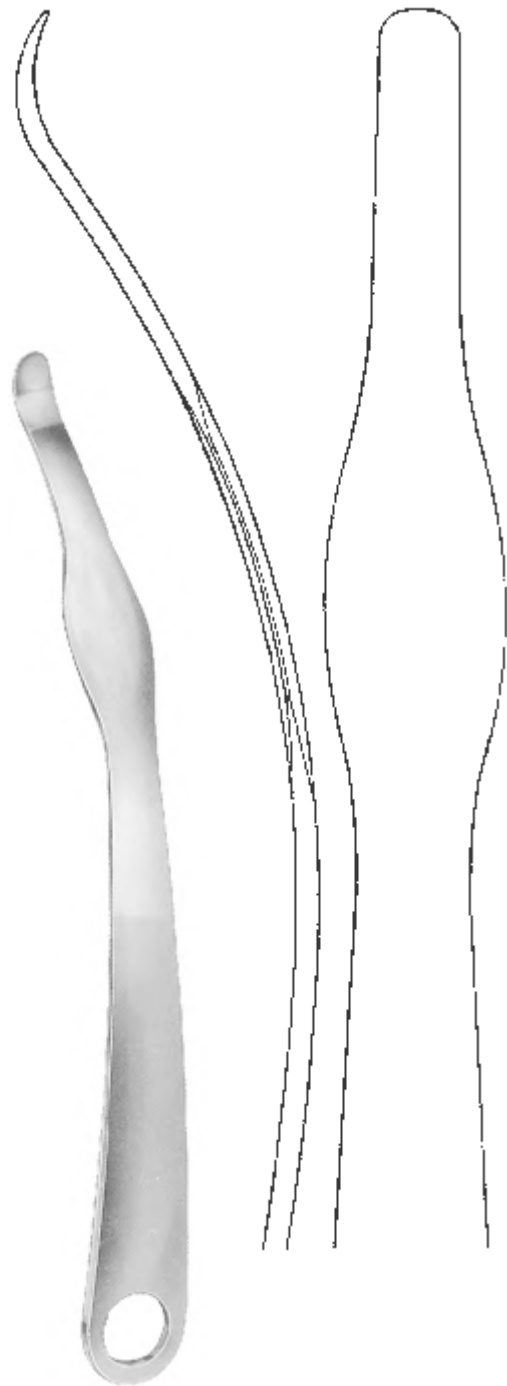

HOHMANN
P5-11010
 260mm (10.1/4")
 Max width: 25mm

BONE LEVERS

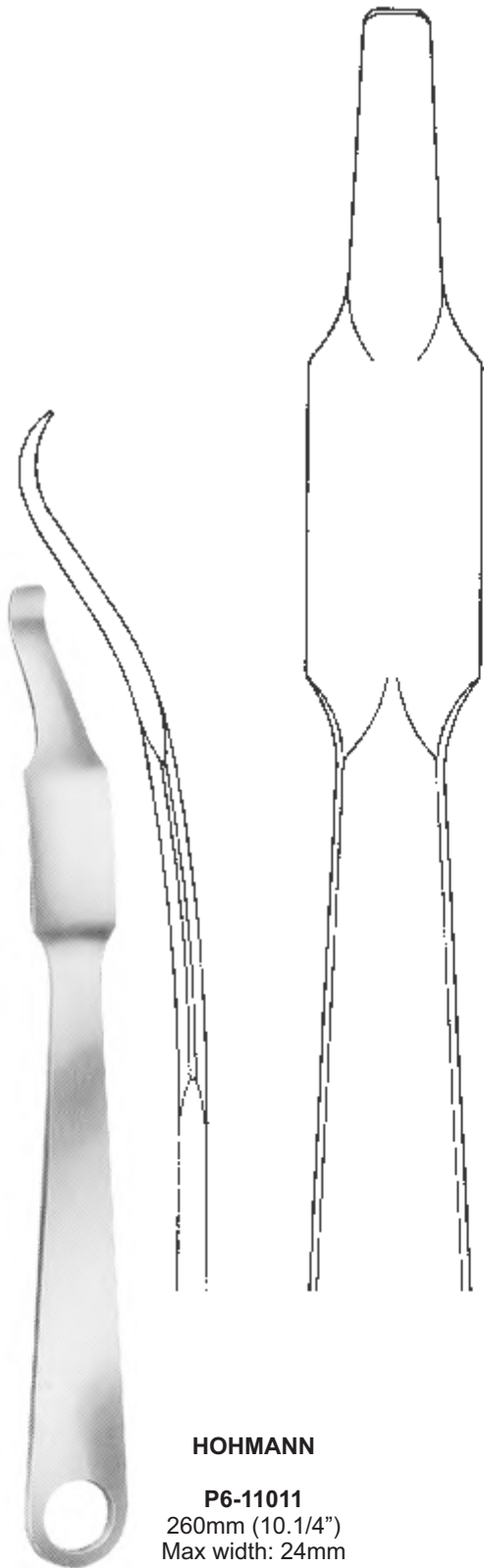

HOHMANN
P6-11011
 260mm (10.1/4")
 Max width: 24mm

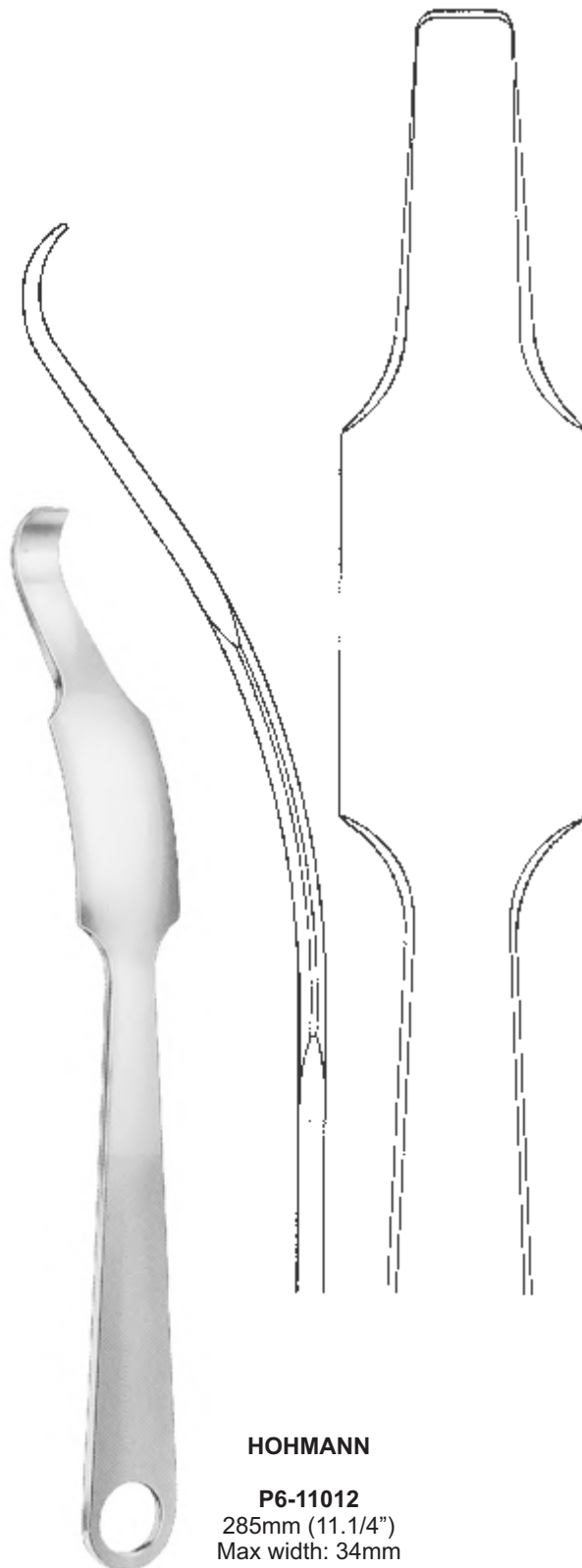

HOHMANN
P6-11012
 285mm (11.1/4")
 Max width: 34mm

■ ■ ■ ■ ■

BONE LEVERS

■ ■ ■ ■ ■

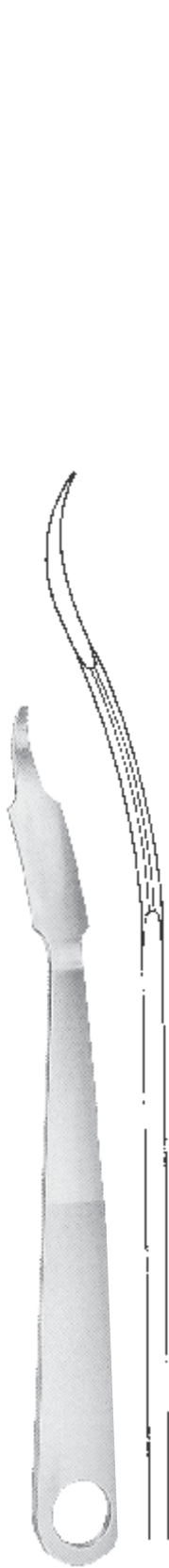

**HOHMANN
 SPIKE RETRACTOR**

P7-11013
 240mm (9.1/2")
 Width: 17mm



**HOHMANN
 SPIKE RETRACTOR**

P7-11014
 240mm (9.1/2")
 Width: 44mm

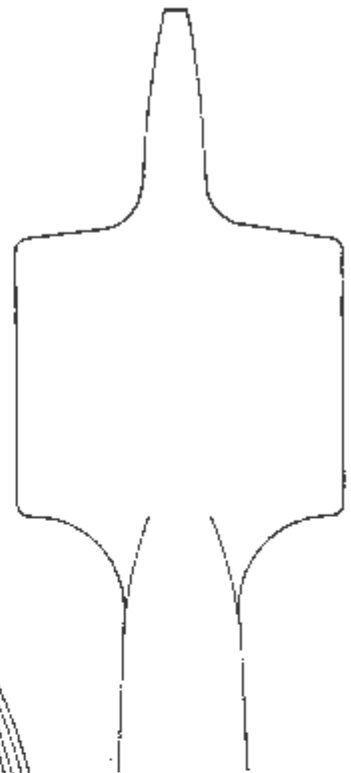

BONE LEVERS



**"COBRA"
HIP LEVER**

P8-11015
 235mm (9.1/4")
 Max Width: 65mm
 Width at tip: 25mm



MINI-HOHMANN

P8-11016
 160mm (6.1/4")
 Max width: 6mm
 Width at tip: 2mm

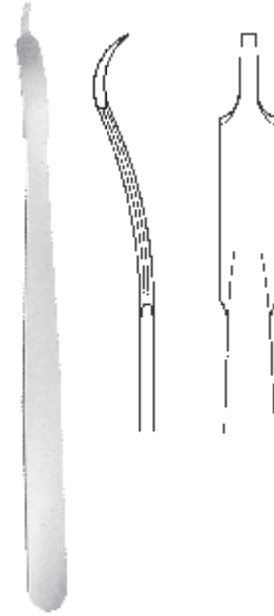

MINI-HOHMANN

P8-11017
 160mm (6.1/4")
 Max width: 8mm
 Width at tip: 2mm

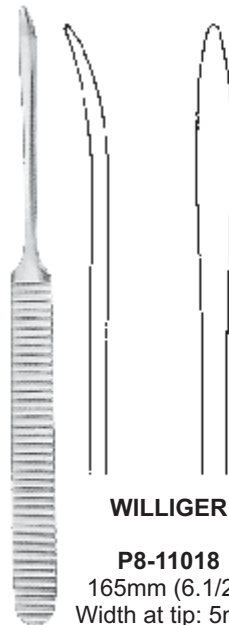

WILLIGER

P8-11018
 165mm (6.1/2")
 Width at tip: 5mm

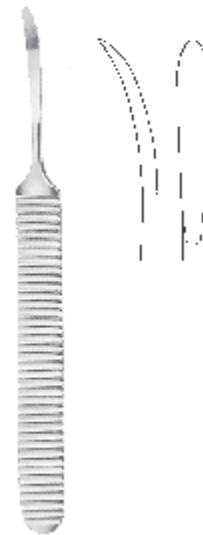

WILLIGER

P8-11019
 140mm (4.1/2")
 Width at tip: 4mm

E-mail: info@baileysurgico.com

BONE LEVERS & RASPATORIES



P9-11020
 140mm (5.1/2")
 Width at tip 2.8mm

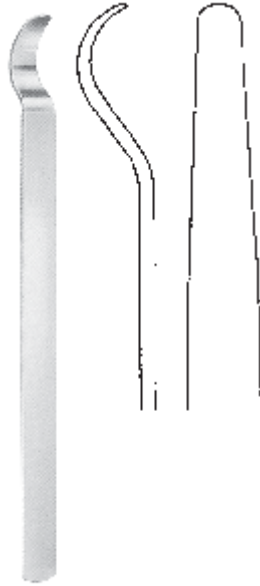

P9-11021
 150mm (6")
 Width at tip 6mm

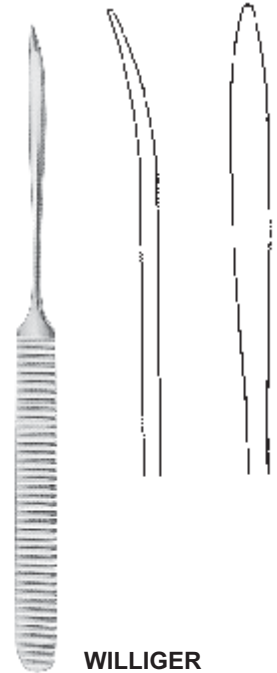

WILLIGER
P9-11022
 175mm (7")
 Width at tip 5.5mm



WILLIGER
P9-11023
 160mm (6.1/4")
 Width at tip 6.5 mm

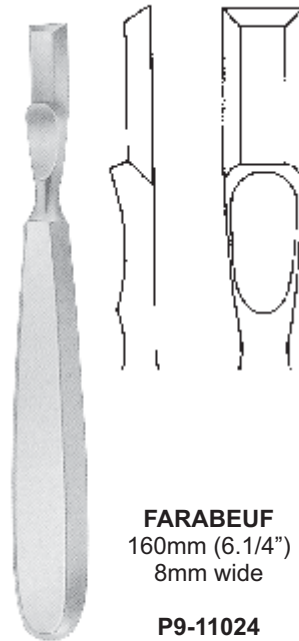

FARABEUF
 160mm (6.1/4")
 8mm wide

P9-11024
 Straight

P9-11025
 Curved



HOWARTH
P9-11026
 230mm (9")



RASPATORIES

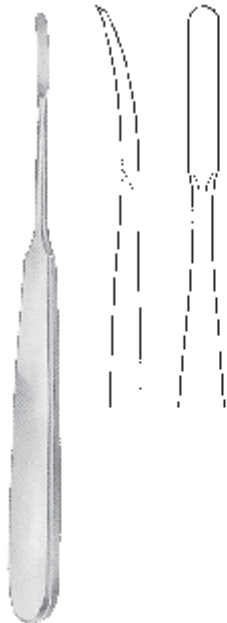

JOSEPH

P10-11027
 170mm (6.3/4")
 Width at tip: 4mm

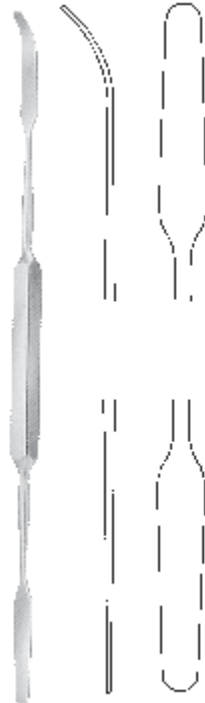

MACDONALD

P10-11028
 185mm (7.1/4") blunt



FREER ELEVATOR

P10-11029
 190mm (7.1/2"), double ended



ADSON

165mm (6.1/2"), curved

P10-11030 width 5mm
P10-11031 width 7mm



ADSON

165mm (6.1/2") slight curve
P10-11032 Width 7mm



PENNYBACKER

150mm (6")
P10-11033 Width 6mm



RASPATORIES

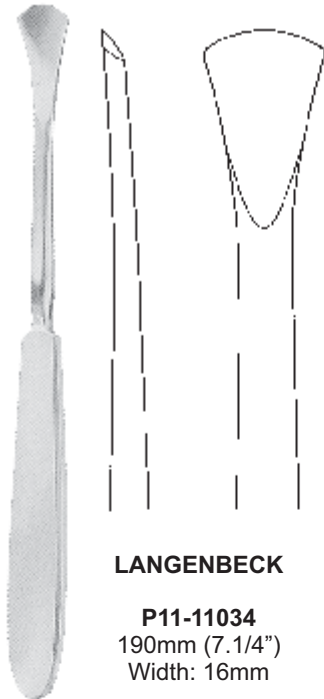

LANGENBECK
P11-11034
 190mm (7.1/4")
 Width: 16mm



MCKISSOCK
P11-11035
 195mm (7.3/4")

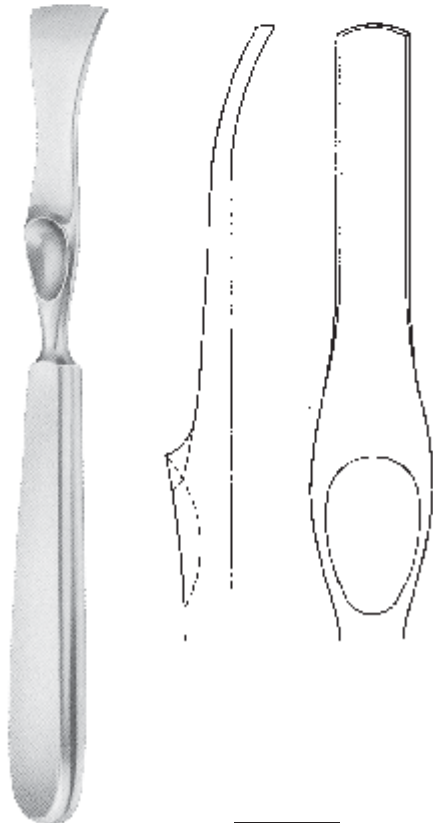

LAMBOTE
 215mm (8.1/2")

P11-11036
 Width: 5mm

P11-11037
 Width: 10mm

P11-11038
 Width: 15mm

P11-11039
 Width: 20mm

P11-11040
 Width: 25mm



BRISTOW
P11-11041
 230mm (9")



RASPATORIES

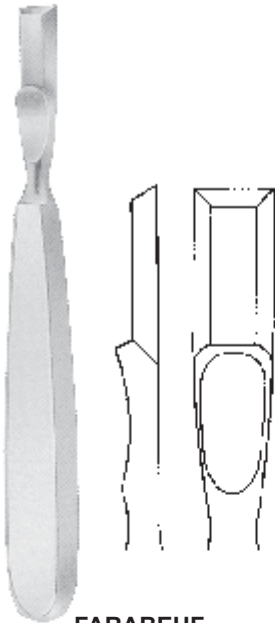

FARABEUF

P12-11042
 160mm (6.1/2")
 Straight

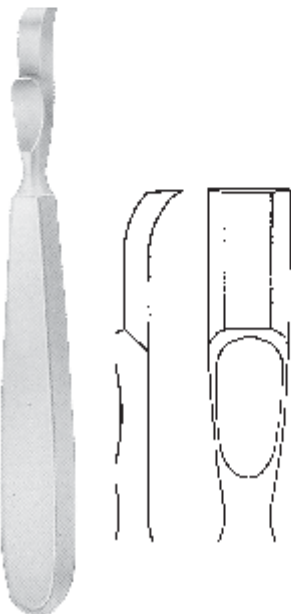

FARABEUF

P12-11043
 160mm (6.1/2")
 Curved



MITCHELL

P12-11044
 210mm (8.1/4")
 Straight edge



JONES

P12-11045
 185mm (7.1/4")
 Convex edge

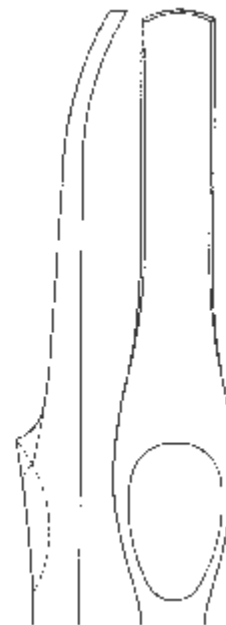

RASPATORIES



BONE FILE AND RASP

P13-11046
 220mm (8.3/4")



P13-11047
 240mm (9.1/2")



PUTTI RASP

P13-11048
 270mm (10.3/4")
 Width: 18mm and 20mm



VOLKMANN
 170mm (6.3/4")

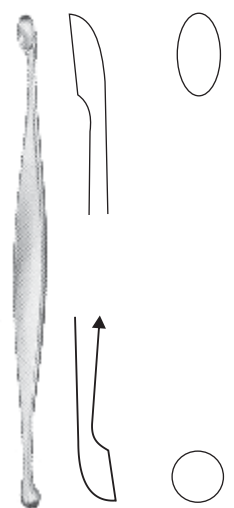
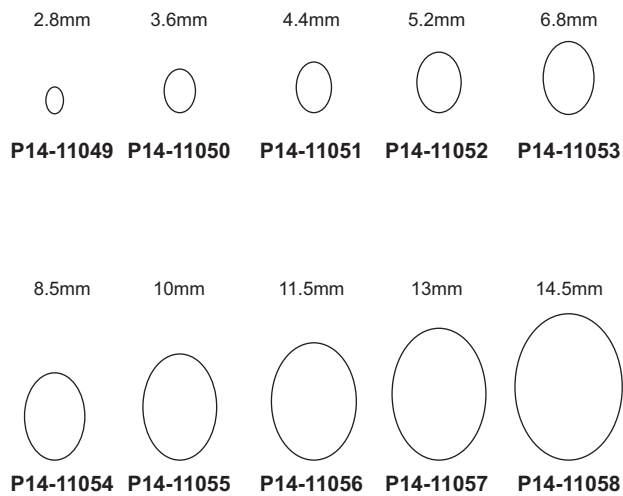

**BOYD
 BONE CURETTE**
 Oval, double ended
P14-11059
 130mm (5.1/8")

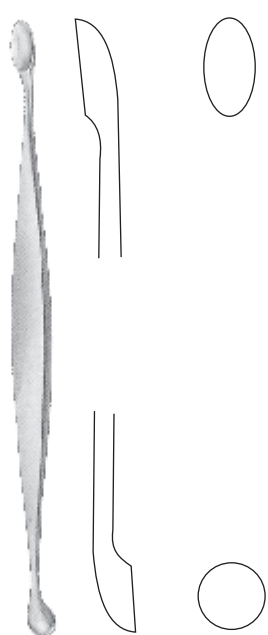

**BOYD
 BONE CURETTE**
 Oval, double ended
P14-11060
 160mm (6.1/4")



**BOYD
 BONE CURETTE**
 Oval, double ended
P14-11061
 200mm (8")

BONE SCOOPS



VOLKMANN
 Double ended
P15-11062
 130mm (5.1/8")
P15-11063
 140mm (5.1/2")
P15-11064
 170mm (6.3/4")



MACEWEN
 180mm (7")
 Combined with seeker
P15-11065
 Oval
P15-11066
 Round

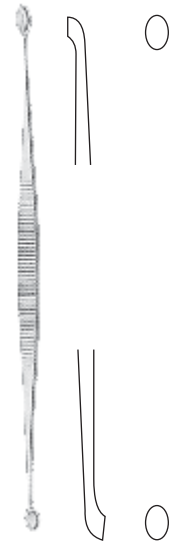

JACOBSON
P15-11067
 140mm (5.1/2")



MARTINI
P15-11068
 140mm (5.1/2")

BONE SCOOPS



MARTINI
P16-11069
 140mm (5.1/2")



LEMPERT
 200mm (8")*

P16-11070
 2mm x 3.5mm

P16-11071
 2mm x 4mm

P16-11072
 2.5mm x 4.5mm

P16-11073
 2.75mm x 5mm

P16-11074
 3mm x 5.5mm

P16-11075
 3.25mm x 6mm



COLLIER AND MORRIS
 180mm (7")

P16-11076
 2mm x 3mm

P16-11077
 3mm x 4mm

P16-11078
 4mm x 5mm

P16-11079
 5mm x 6mm

OSTEOTOMES, CHISELS & GOUGES



SWEDISH MODEL CHISELS
 200mm (8")
 Straight

P17-12000
 Width: 10mm

P17-12001
 Width: 15mm

P17-12002
 Width: 20mm

P17-12003
 Width: 25mm

P17-12004
 Width: 30mm

CAPENER CHISELS
 255mm (10")
 With Tufnal Handle
 Straight

P17-12005
 Width: 6mm

P17-12006
 Width: 8mm

P17-12007
 Width: 10mm

P17-12008
 Width: 12mm

P17-12009
 Width: 15mm

P17-12010
 Width: 20mm

P17-12011
 Width: 25mm

P17-12012
 Width: 30mm

CAPENER CHISELS
 255mm (10")
 With Tufnal Handle
 Curved

P17-12013
 Width: 6mm

P17-12014
 Width: 8mm

P17-12015
 Width: 10mm

P17-12016
 Width: 12mm

P17-12017
 Width: 15mm

P17-12018
 Width: 20mm

P17-12019
 Width: 25mm

P17-12020
 Width: 30mm

SWEDISH MODEL OSTEOTOME
 200mm (8")
 Straight

P17-12021
 Width: 10mm

P17-12022
 Width: 15mm

P17-12023
 Width: 20mm

P17-12024
 Width: 25mm

P17-12025
 Width: 30mm

SMITH-PETERSON OSTEOTOME
 200mm (8")
 Straight

P17-12026
 Width: 10mm

P17-12027
 Width: 15mm

P17-12028
 Width: 20mm

P17-12029
 Width: 25mm

P17-12030
 Width: 30mm

OSTEOTOMES, CHISELS & GOUGES

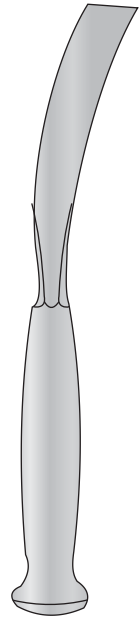

**SMITH-PETERSON
 OSTEOTOME**
 200mm (8")
 Curved

- P18-12031**
Width: 10mm
- P18-12032**
Width: 15mm
- P18-12033**
Width: 20mm
- P18-12034**
Width: 25mm
- P18-12035**
Width: 30mm



CAPENER OSTEOTOME
 255mm (10")
 With Tufnal Handle
 Straight

- P18-12036**
Width: 10mm
- P18-12037**
Width: 12mm
- P18-12038**
Width: 15mm
- P18-12039**
Width: 20mm
- P18-12040**
Width: 25mm
- P18-12041**
Width: 30mm



**LAMBOTTE
 OSTEOTOME**
 245mm (9.3/4")
 Straight

- P18-12042**
Width: 4mm
- P18-12043**
Width: 8mm
- P18-12044**
Width: 10mm
- P18-12045**
Width: 13mm
- P18-12046**
Width: 15mm
- P18-12047**
Width: 18mm
- P18-12048**
Width: 20mm
- P18-12049**
Width: 25mm
- P18-12050**
Width: 30mm
- P18-12051**
Width: 38mm
- P18-12052**
Width: 44mm
- P18-12053**
Width: 50mm



CAPENER OSTEOTOME
 255mm (10")
 With Tufnal Handle
 Curved

- P18-12054**
Width: 10mm
- P18-12055**
Width: 12mm
- P18-12056**
Width: 15mm
- P18-12057**
Width: 20mm
- P18-12058**
Width: 25mm
- P18-12059**
Width: 30mm



**HIBBS
 OSTEOTOME**
 200mm (8")
 Straight

P19-12060
 Width: 12mm

P19-12061
 Width: 15mm

P19-12062
 Width: 20mm

P19-12063
 Width: 25mm



GOUGES
 230mm (9")
 With Tufnal Handle
 Straight

P19-12064
 Width: 10mm

P19-12065
 Width: 15mm

P19-12066
 Width: 20mm

P19-12067
 Width: 25mm

OSTEOTOMES, CHISELS & GOUGES

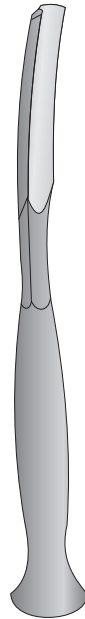
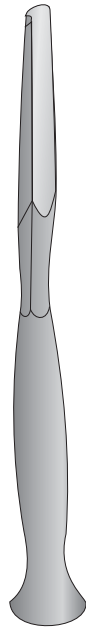

**SMITH-PETERSEN
 GOUGES**
 200mm (8")
 Straight

**SMITH-PETERSEN
 GOUGES**
 200mm (8")
 Concave

P20-12068
 Width: 10mm

P20-12072
 Width: 10mm

P20-12069
 Width: 15mm

P20-12073
 Width: 15mm

P20-12070
 Width: 20mm

P20-12074
 Width: 20mm

P20-12071
 Width: 25mm

P20-12075
 Width: 25mm

■ ■ ■ ■ ■
MALLETS



LUCAE

Q1-13000
 Diameter: 27mm
 8.1/2 oz



KELSEY FRY

Q1-13001
 190mm (7.1/2")
 Diameter: 20mm

SPARE DISKS

Q1-13002
 Spare disks for
 Kelsey-Fry Mallet



HEATH

Q1-13003
 Diameter: 25mm
 28 oz

Q1-13004
 Diameter: 40mm
 36 oz

MALLETS

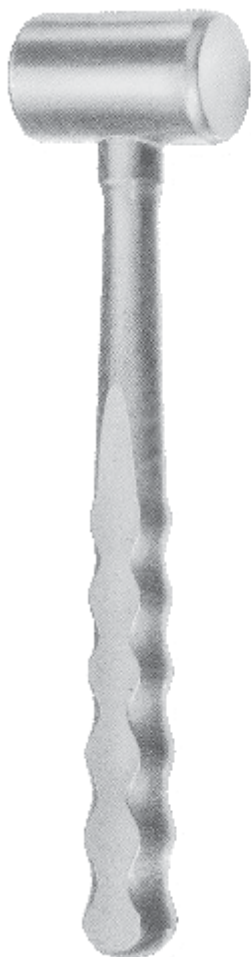

TUFNOL Mallet
250mm (10")

Q2-13005
Diameter: 35mm

Q2-13006
Diameter: 42mm

Q2-13007
Diameter: 50mm



Q2-13008
230mm (9")
Diameter: 35mm

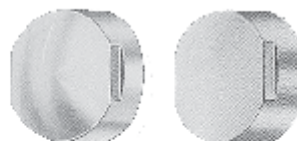

Q2-13009
One metal disk, flat
One metal disk, convex



Q2-13010
One plastic disk, flat
One Plastic disk, Convex



Q2-13011
Wrench

■ ■ ■ ■ ■
MALLETS



Q3-13015
 Led Hand Child
Q3-13016
 Led Hand Adult



FICKLING DENTAL
Q3-13012
 190mm (7.1/2")
 165 gm



HERMANN
Q3-13013
 195mm (7.3/4")



Q3-13014
 185mm (7.1/4")
 One side flat
 One side convex



Q3-13017
 Sommerlad mapping pen
 adjustable tip
 150mm (6")

BONE HOLDING FORCEPS

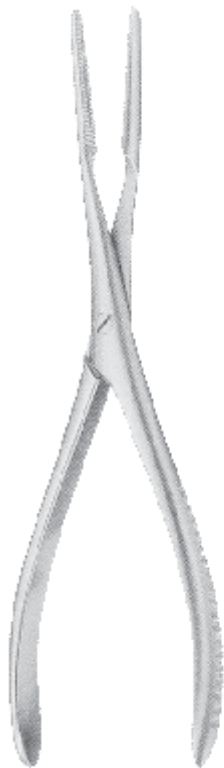

**SEQUESTUM
FORCEPS**

Q4-14000
190mm (7.1/2")
Straight



**SEQUESTRUM
FORCEPS**

Q4-14001
190mm (7.1/2")
Angled

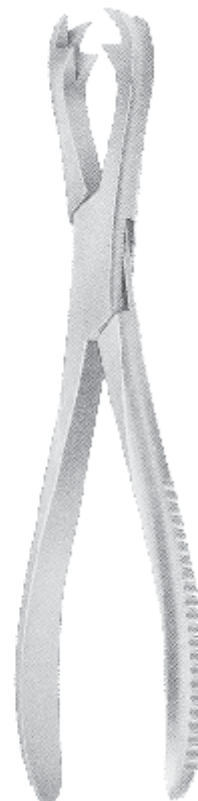

FERGUSSON

Q4-14002
200mm (8")

BONE HOLDING FORCEPS

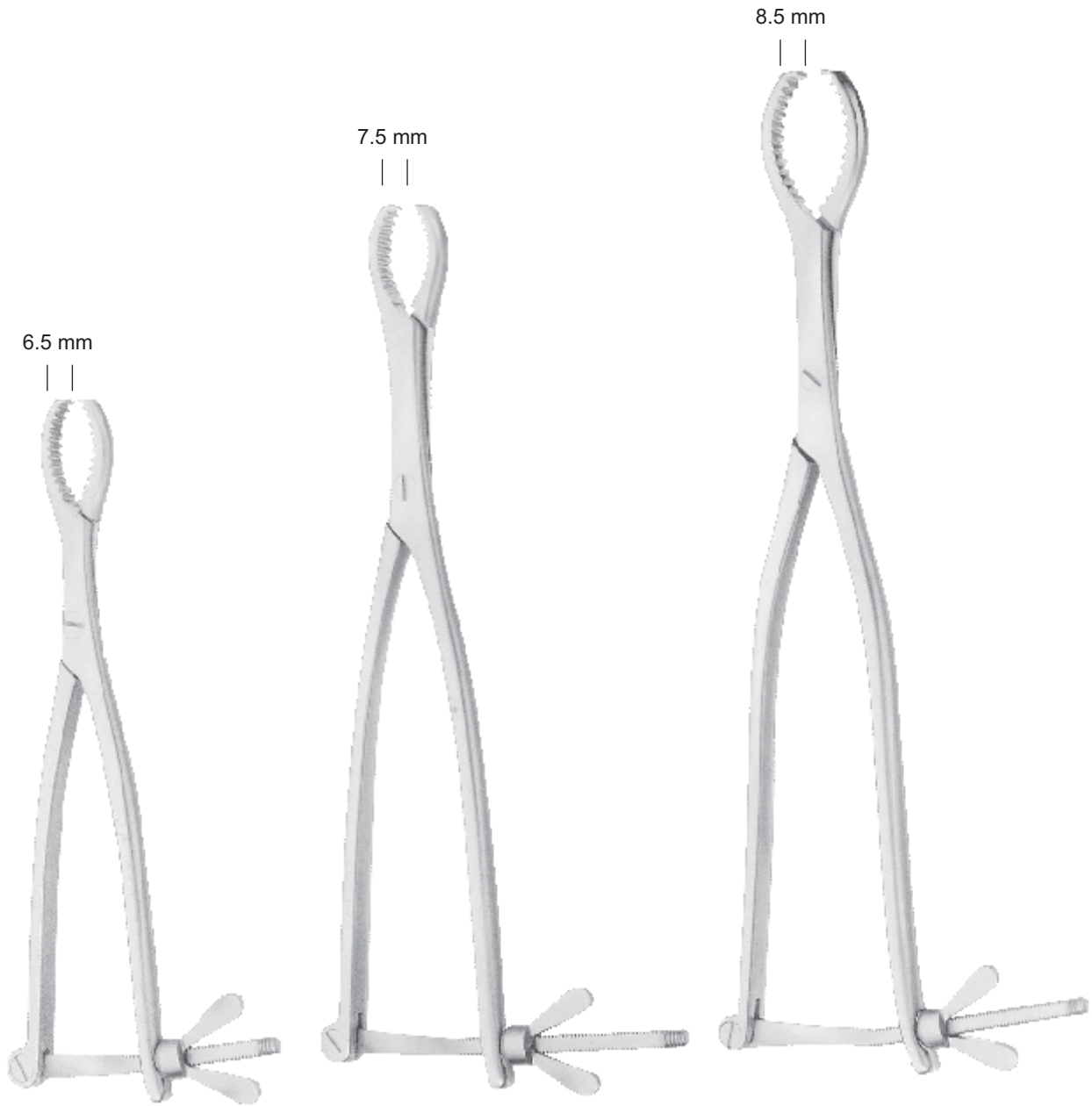

HEY GROVES

Q5-14003
 200mm (8")

HEY GROVES

Q5-14004
 255mm (10")

HEY GROVES

Q5-14005
 305mm (12")

BONE HOLDING FORCEPS

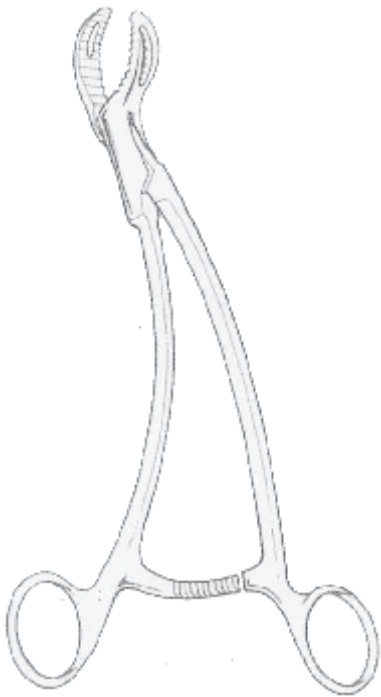

BURNS
Q6-14006
185mm (7.1/4")

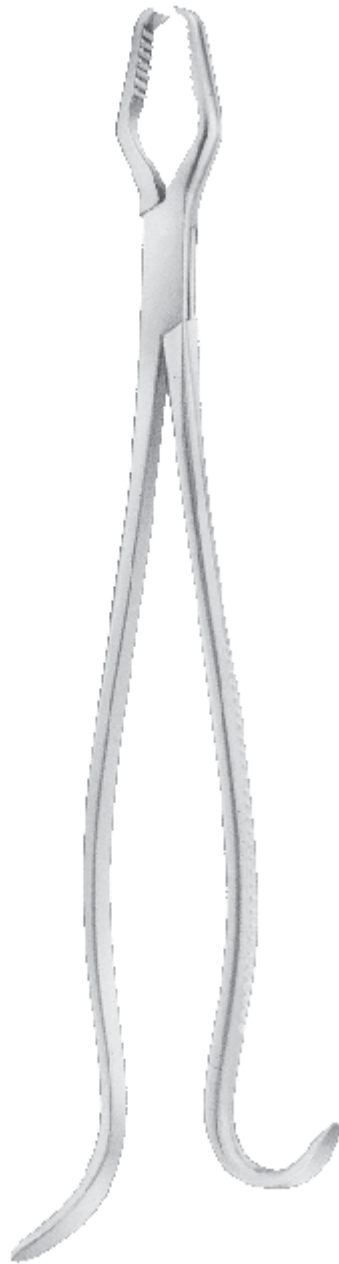

LANE
Q6-14007
320mm (12.1/2")



LOWMAN
Q6-14008
125mm (5")
Q6-14009
175mm (6.3/4")

BONE HOLDING FORCEPS



Q7-14010
 250mm (9.3/4")



Q7-14011
 255mm (10")



Q7-14013
 175mm (7")



VERBRUGGE



Q7-14012
 265mm (10.1/2")



LEWIN
Q7-14014
 135mm (5.1/4")

BONE HOLDING FORCEPS

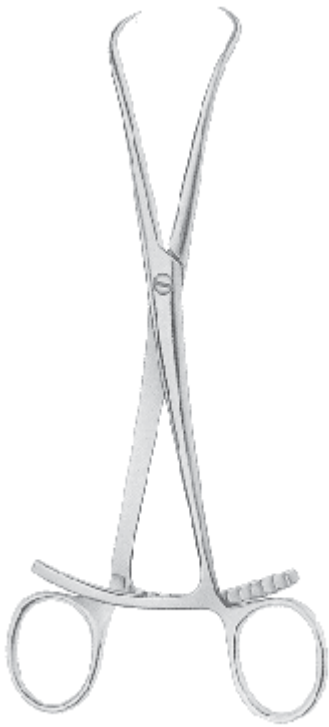

LEWIN
Q8-14015
 205mm (8")



Q8-14017
 190mm (7.1/2")
 Light pattern
Q8-14018
 190mm (7.1/2")
 Heavy pattern

DINGMAN

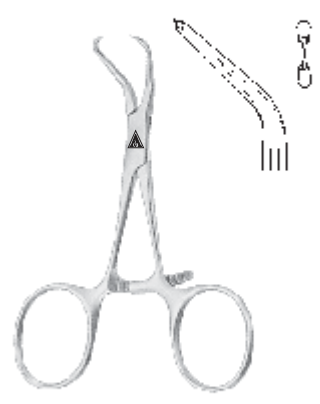

LEWIN
Q8-14016
 95mm (3.3/4")



8mm
SEMB
Q8-14019
 190mm (7.1/2")



7.5mm
KERN-MINI
Q8-14020
 155mm (6")

BONE HOLDING FORCEPS



KERN - LANE
Q9-14021
240mm (9.1/2")



LANE
Q9-14022
320mm (12.3/4")

BONE RONGEURS



BEYER

Q10-15000
 150mm (6")
 5mm bite



**JANSEN-MIDDLETON
 SEPTUM FORCEPS**

Q10-15001
 200mm (8") Spoon shaped
 4mm bite



CAIRNS

Q10-15002
 140mm (5.1/2")
 4mm bite



CAIRNS

Q10-15003
 140mm (5.1/2")
 4mm bite



LUER

Q10-15004
 155mm (6")



RUSKIN

Q10-15005
 190mm (7.1/2")
 6mm bite

BONE RONGEURS

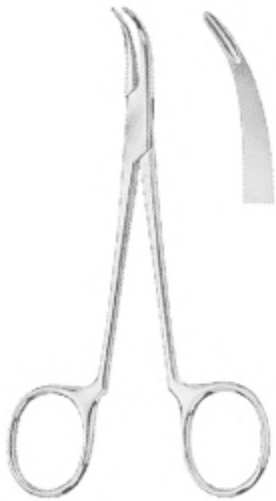

SYNOVECTOMY RONGEUR
Q11-15006
 130mm (5.1/8") Jaw width 2mm

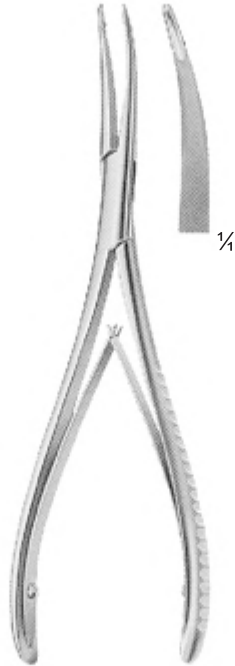

SYNOVECTOMY RONGEUR
Q11-15007
 175mm (7")

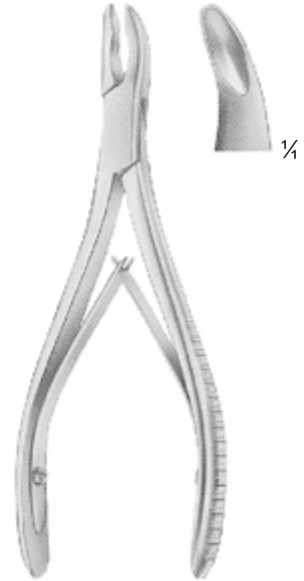

JANSEN
Q11-15008
 150mm (6")

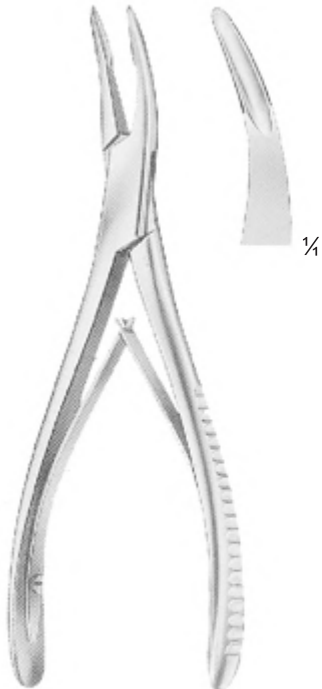

HARTMANN
Q11-15009
 180mm (7")



MEAD
Q11-15010
 165mm (6.1/2")



NORTHFIELD
Q11-15011
 200mm (8")
 10mm bite



BONE RONGEURS



PENNYBACKER

Q12-15012
200mm (8")
4mm bite



WILMS

Q12-15013
200mm (8")
4mm bite



HEANLEY

Q12-15014
175mm (7")
4mm bite



TROTTER

Q12-15015
200mm (8")
10mm bite

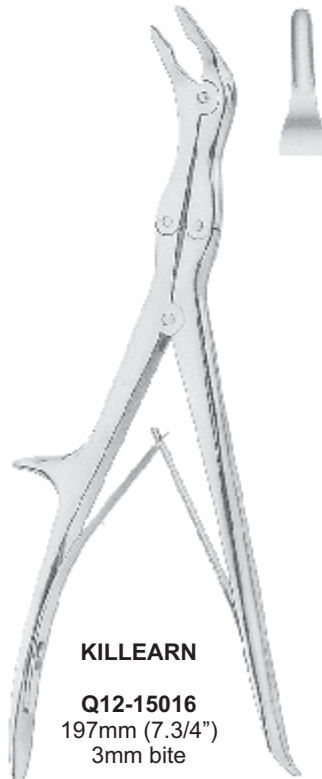

KILLEARN

Q12-15016
197mm (7.3/4")
3mm bite

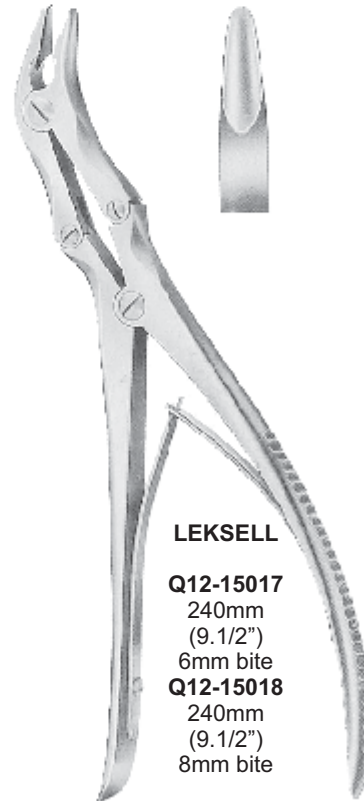

LEKSELL

Q12-15017
240mm
(9.1/2")
6mm bite
Q12-15018
240mm
(9.1/2")
8mm bite



BONE RONGEURS



GIGLI SAW WITH HANDLE

Q13-15022
 500mm (20")

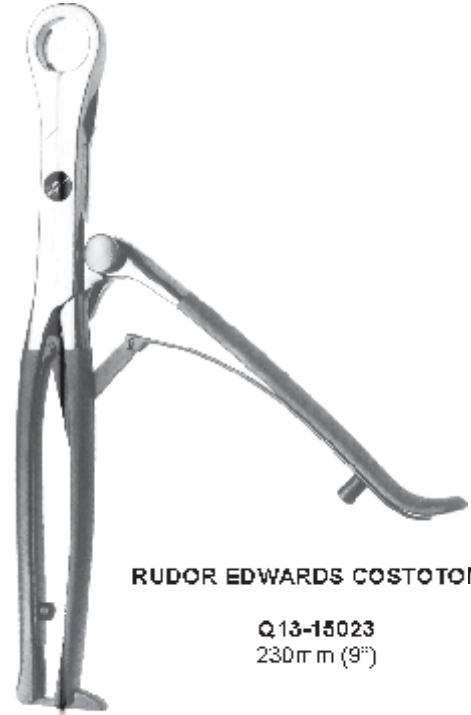

RUDOR EDWARDS COSTOTOME

Q13-15023
 230mm (9")



LUER-JANSEN

Q13-15019
 170mm (6.3/4") 4mm bite

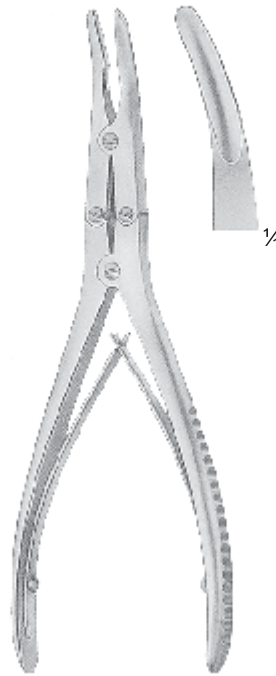

BEYER

Q13-15020
 180mm (7")



BEYER

Q13-15021
 200mm (8")



BONE RONGEURS



ZAUFAL-JANSEN

Q14-15024
240mm (9.1/2")



ECHLIN

Q14-15025
240mm (9.1/2")

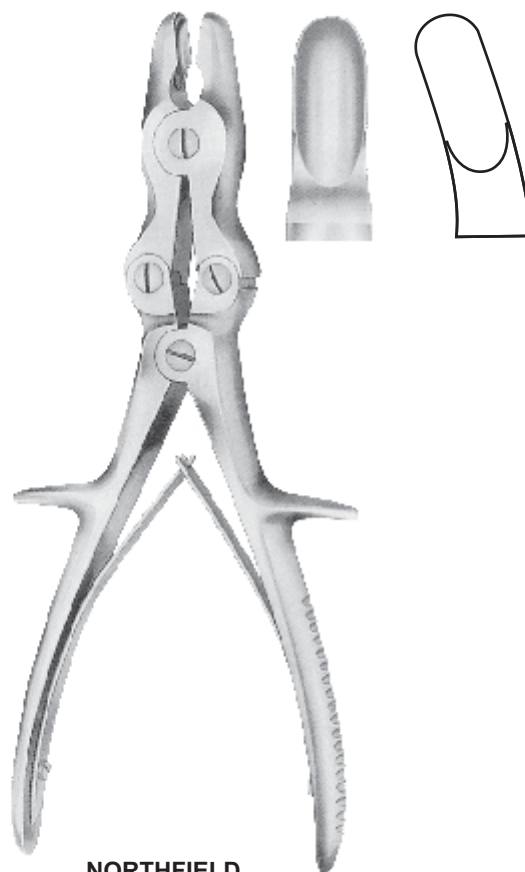

NORTHFIELD

Q14-15026
225mm (9")
10mm bite



BONE RONGEURS



SARGENT (VAN HAVRE)

Q15-15027
 220mm (8.3/4")
 10mm bite



OLIVECRONA

Q15-15028
 230mm (9")
 6mm bite



STILLE-RUSKIN

Q15-15029
 240mm (9.1/2")



BONE RONGEURS

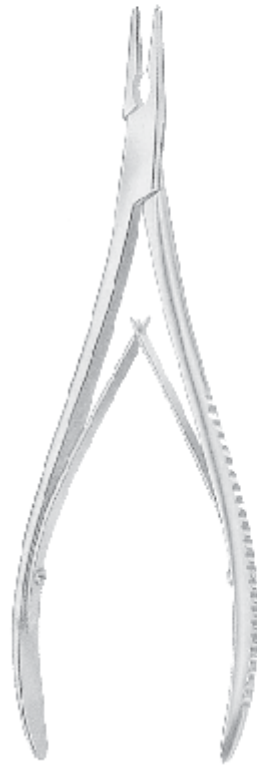

LEMPERT
190mm (7.1/2")
3mm bite
Q16-15030 - Straight
Q16-15031 - Curved



JANSEN - STRUYCKEN
SEPTUM FORCEPS
Q16-15032
210mm (8.1/4")



DISC RONGEURS

BECK RONGEUR

Q17-15033
 Shaft: 130mm (5.1/8")
 2mm bite



CUSHING (CAIRNS) RONGEUR

Shaft: 130mm (5.1/8")

Q17-15034
 4mm bite

Q17-15035
 5mm bite

Q17-15036
 7mm bite



CUSHING RONGEURS

Shaft: 130mm (5.1/8")

Q17-15037
 3mm bite

Q17-15038
 4mm bite

Q17-15039
 5mm bite



CUSHING RONGEURS

Shaft 130mm (5.1/8")

Q17-15040
 3mm bite

Q17-15041
 4mm bite



DISC RONGEURS



Q18-15042
Shaft: 180mm (7")
10mm bite



Q18-15043
Shaft: 180mm (7")
10mm bite



Q18-15044
Shaft: 180mm (7")
10mm bite

BONE CUTTING FORCEPS



LISTON
 Straight



Q19-16000
 140mm (5.1/2")



Q19-16001
 170mm (6.3/4")



Q19-16002
 200mm (8")



Q19-16003
 220mm (8.3/4")



LISTON
 Curved on flat

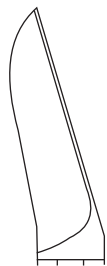

Q19-16004
 170mm (6.3/4")

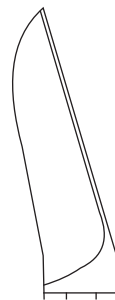

Q19-16005
 200mm (8")

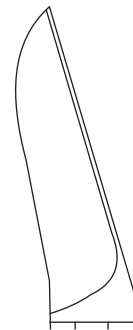

Q19-16006
 220mm (8.3/4")

BONE CUTTING FORCEPS



STAMM
Q20-16007
 150mm (6")



HORSLEY LISTON
Q20-16008
 255mm (10")
 Straight
Q20-16009
 255mm (10")
 Curved on flat



MCINDOE
Q20-16010
 170mm (6.3/4")

BONE CUTTING FORCEPS

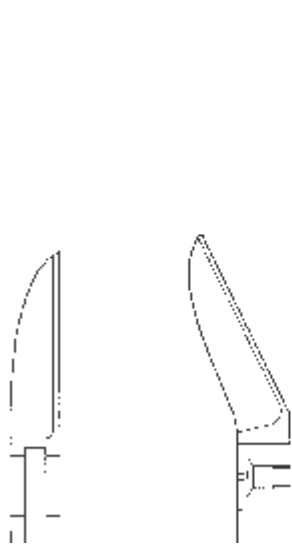

RUSKIN - LISTON

Q21-16011
 190mm (7.1/2")
 Straight

Q21-16012
 190mm (7.1/2")
 Angled on flat

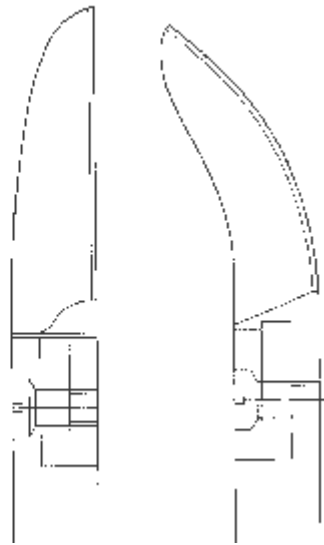

STILLE LISTON

Q21-16013
 280mm (11")
 Straight

Q21-16014
 275mm (10.3/4")
 Curved on flat



Q21-16015
 150mm (6")

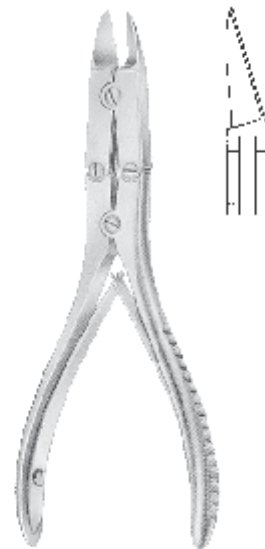

Q21-16016
 145mm (5.3/4")



BONE CUTTING FORCEPS



WARD

Q22-16017
 170mm (6.3/4")

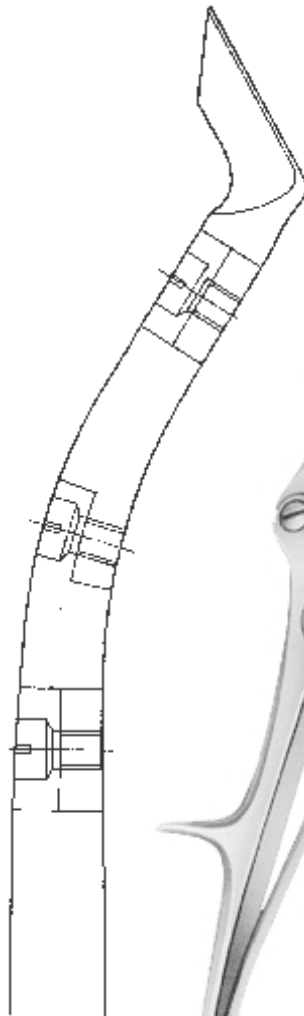

DE VILBISS

Q22-16018
 210mm (8.1/4")



LISTON (TUDOR EDWARDS)

Q22-16019
 265mm (10.1/2")



**PLASTER CAST
 REMOVAL INSTRUMENTS**



PLASTER KNIFE

R1-17000
 180mm (7")



CAST BENDING FORCEPS

R1-17001
 180mm (7")
R1-17002
 240mm (9.1/2")



**HENNIG
 PLASTER SPREADER**

R1-17003
 270mm (10.3/4")



**GUY'S (BOHLER)
 PLASTER SHEARS**

R1-17004
 240mm (9.1/2")
 Flattened probe end

PLASTER CAST REMOVAL INSTRUMENTS



PLASTER SHEARS

R2-17005
160mm (6.1/4")



PLASTER SHEARS

R2-17006
200mm (8")

R2-17007
230mm (9")



PLASTER SHEARS

R2-17008
235mm (9.1/4")

■ ■ ■ ■ ■

BONE & RIB SHEARS

■ ■ ■ ■ ■



S1-18001
 230mm (9")



S1-18002
 220mm(8.3/4")

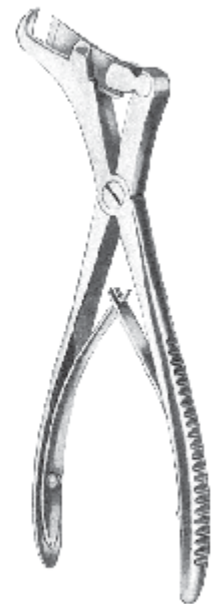

S1-18003
 170mm (6.3/4")



GLUCK
S1-18004
 220mm (8.3/4")

With eccentric sliding blade



STILLE
S1-18005
 210mm (8.1/4")



BONE & RIB SHEARS



SAUERBRUCH

S2-18006
 260mm (10.1/4")



GIERTZ STILLE

S2-18007
 270mm (10.1/2")

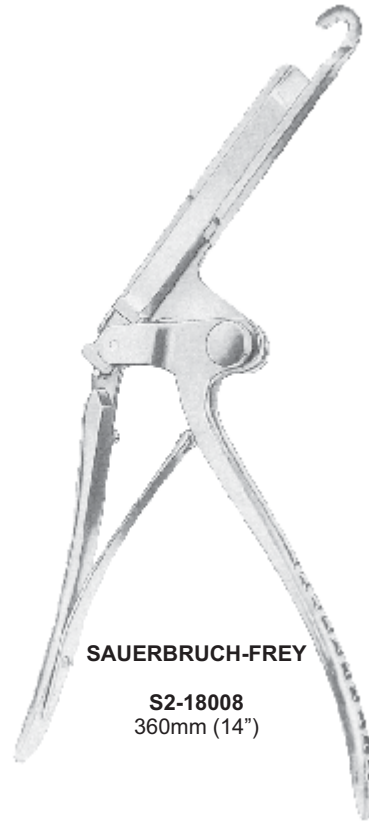

SAUERBRUCH-FREY

S2-18008
 360mm (14")



LEBSCHKE

S2-18009
 250mm (10")

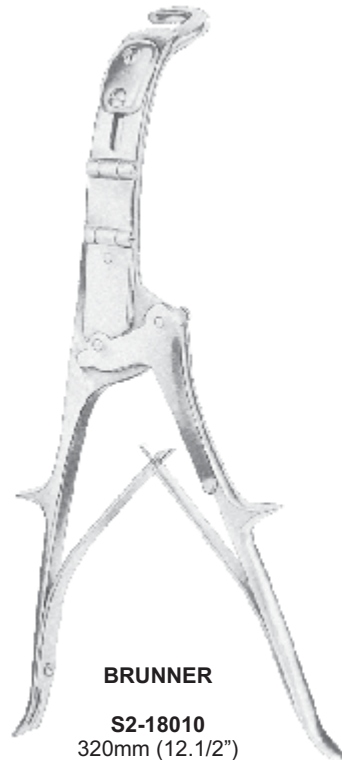

BRUNNER

S2-18010
 320mm (12.1/2")



LEBSCHKE

S2-18011
 245mm (9.3/4")



RIB SPREADERS

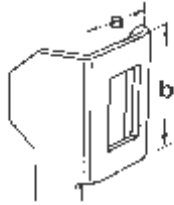

COOLEY
S3-18012
 For new borns

A	B	C
12 mm	16 mm	95 mm

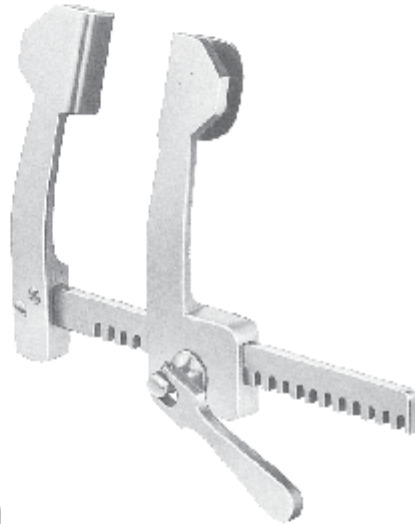
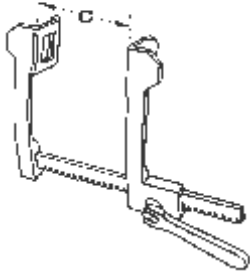

COOLEY
S3-18013
 Pediatric size

A	B	C
15 mm	30 mm	140 mm
21 mm	44 mm	150 mm

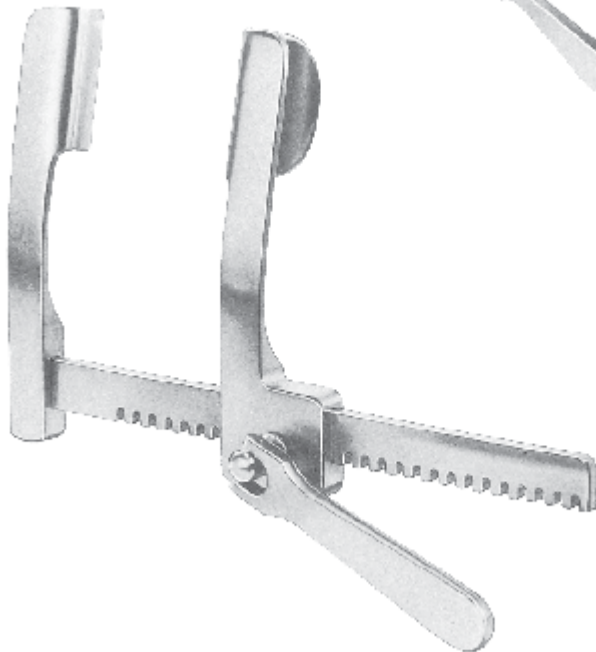

COOLEY
S3-18014
 For adults

A	B	C
35 mm	50 mm	200 mm



RIB SPREADERS

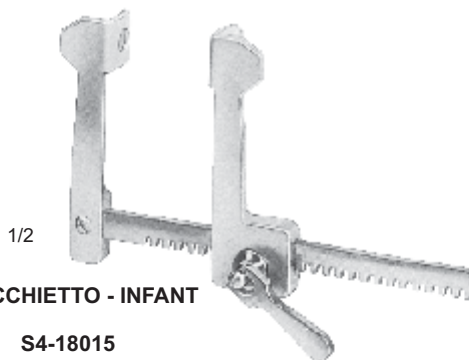
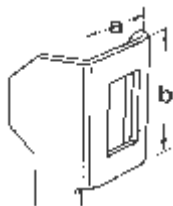

FINOCCHIETTO - INFANT

S4-18015
For babies

a	b	c
15mm	15mm	75mm

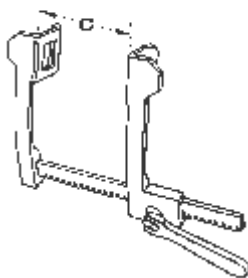

FINOCCHIETTO-BABY

S4-18016
Child size

a	b	c
31mm	31mm	100mm

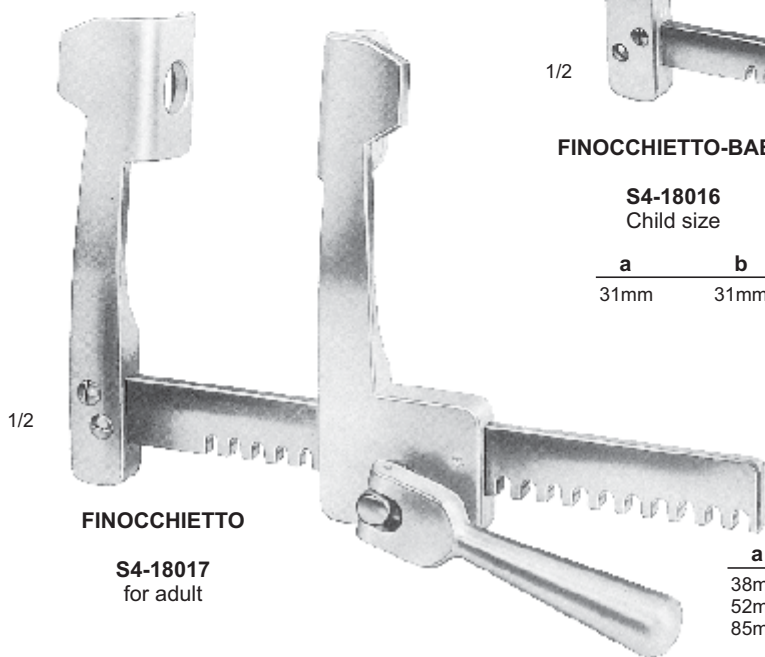

FINOCCHIETTO

S4-18017
for adult

a	b	c
38mm	44mm	135mm
52mm	62mm	175mm
85mm	65mm	175mm



RIB SPREADERS

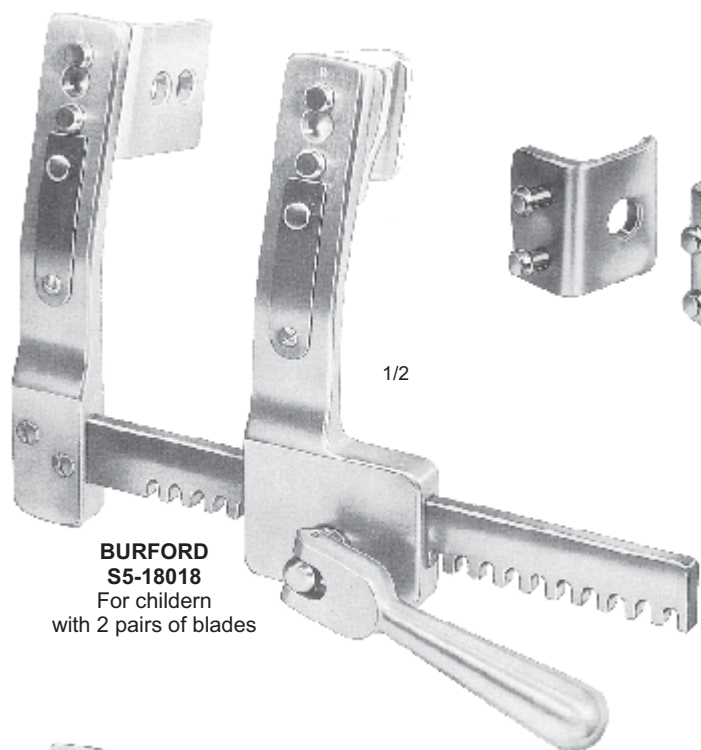

1/2

**BURFORD
 S5-18018**
 For children
 with 2 pairs of blades

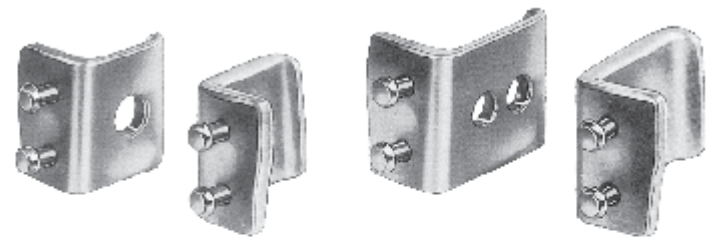

a	b	c
48mm	42mm	135mm
34mm	42mm	135mm

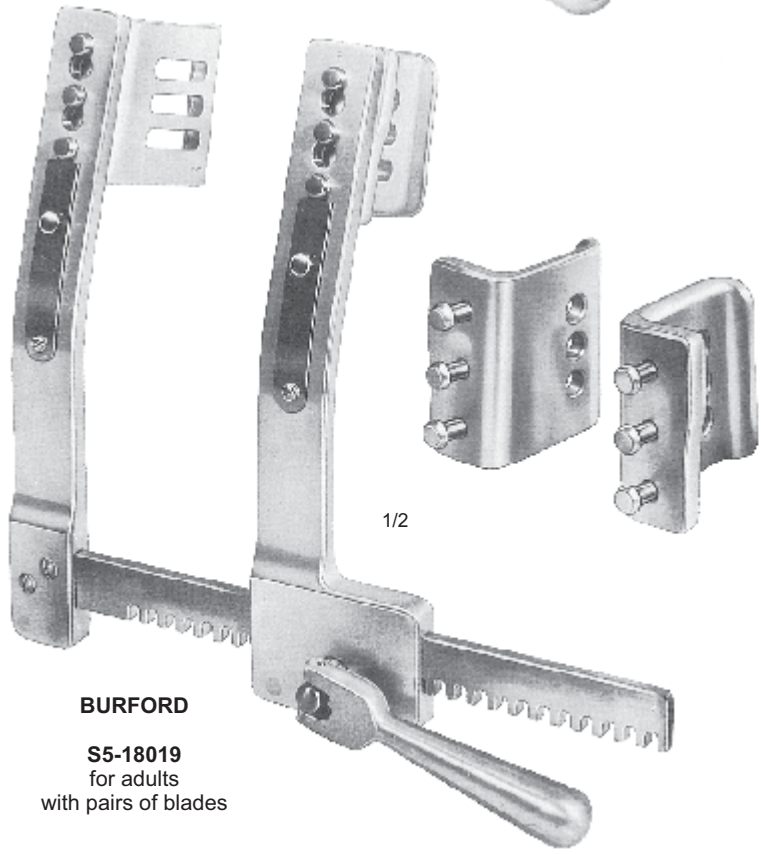

1/2

**BURFORD
 S5-18019**
 for adults
 with pairs of blades

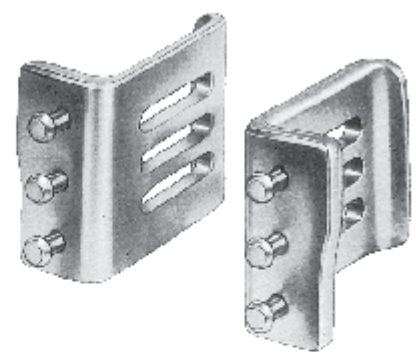

a	b	c
64mm	62mm	180mm
47mm	62mm	
65mm	62mm	260mm
47mm	62mm	
65mm	62mm	300mm
47mm	62mm	



RIB SPREADERS

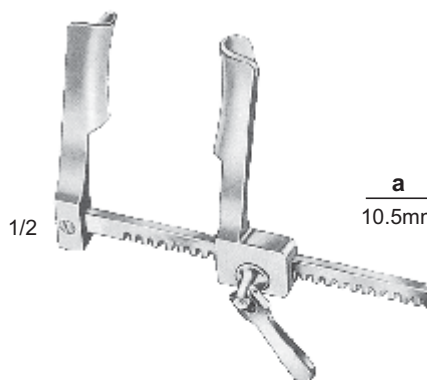
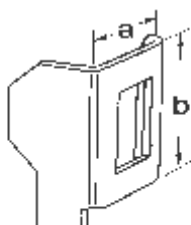

CASTANEDA

S6-18020

a	b	c
10.5mm	32mm	65mm

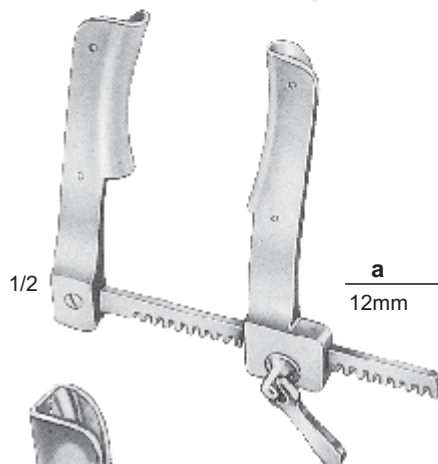
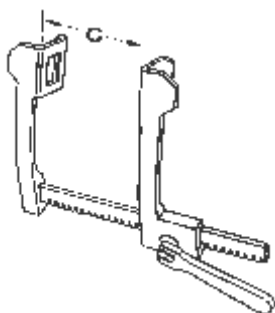

CASTANEDA

S6-18021

a	b	c
12mm	45mm	70mm

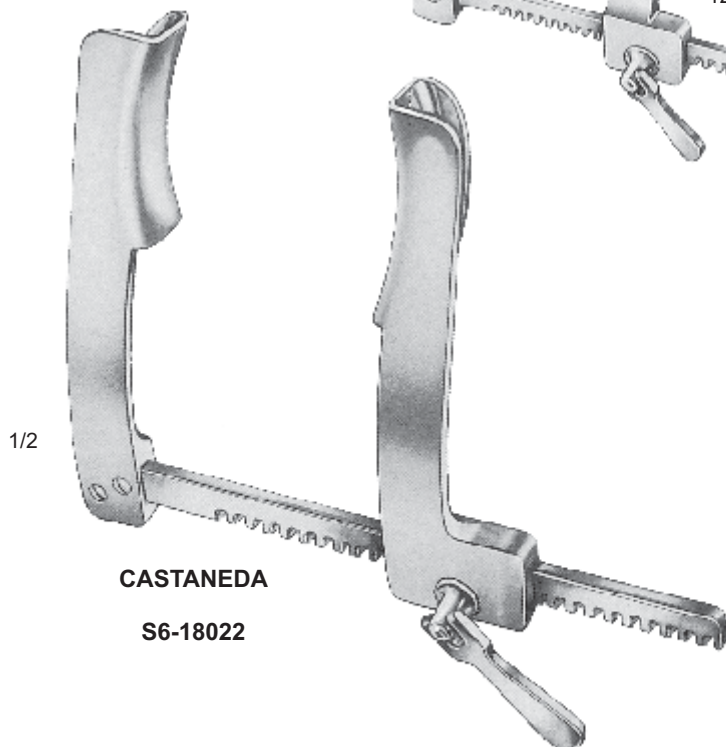

CASTANEDA

S6-18022



RIB SPREADERS

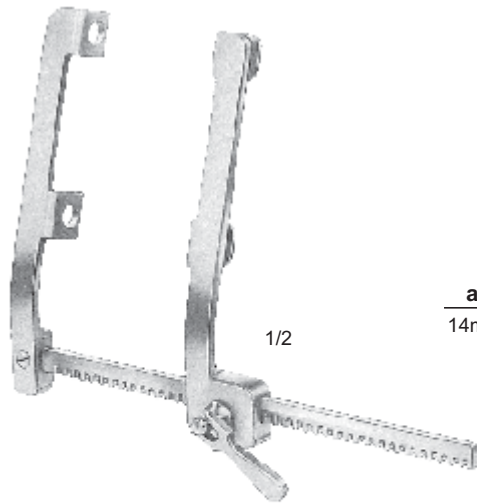

FINOCCHIETTO (Modif)
S7-18023

a	b	c	d
14mm	14mm	120mm	110mm

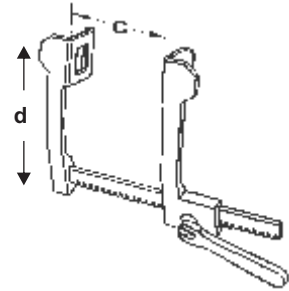
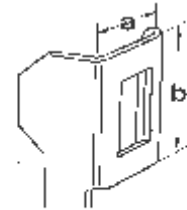

HAIGHT
S7-18024

a	b	c
30mm	30mm	90mm

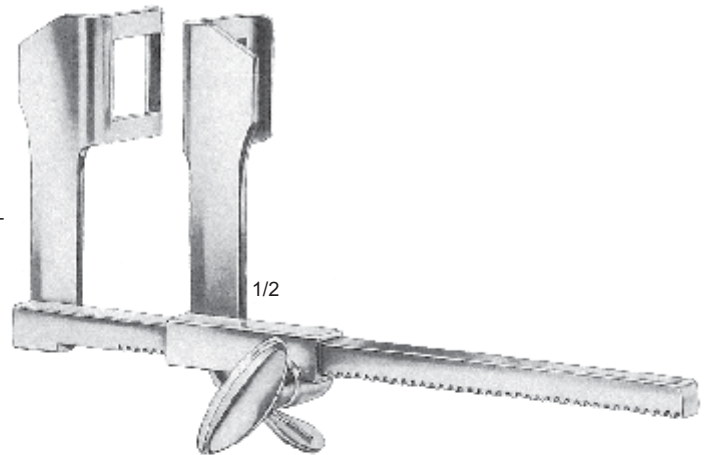

TUFFIER
S7-18025

a	b	c
50mm	45mm	165mm

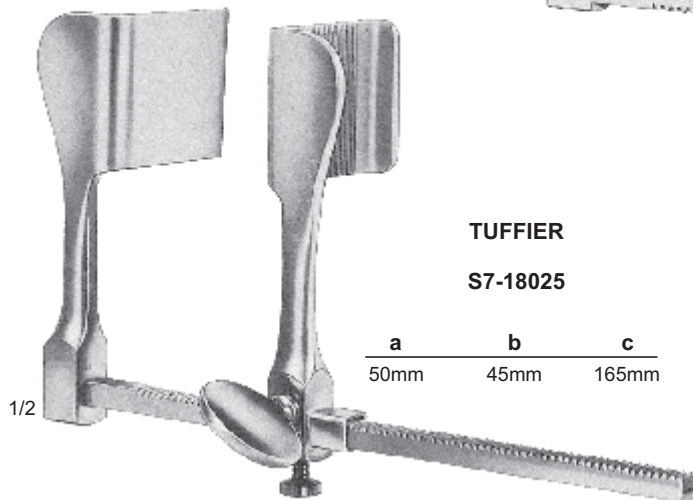



RIB SPREADERS

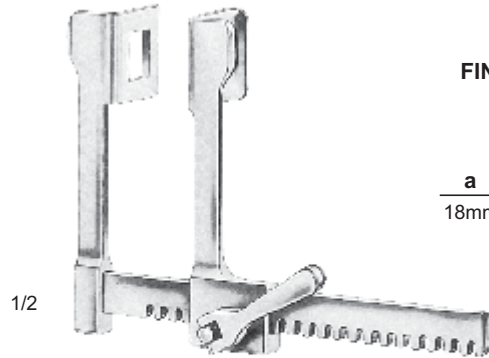
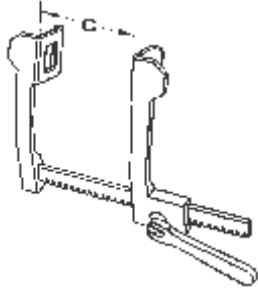
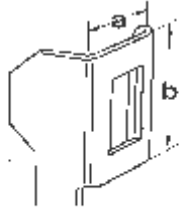

FINOCCHIETTO - BABY

S8-18026

a	b	c
18mm	20mm	75mm

FINOCCHIETTO

S8-18027

- Small pattern
 - a: 40mm
 - b: 40mm
 - c: 165mm
- Medium pattern
 - a: 45mm
 - b: 65mm
 - c: 200mm
- Large pattern
 - a: 70mm
 - b: 65mm
 - c: 250mm

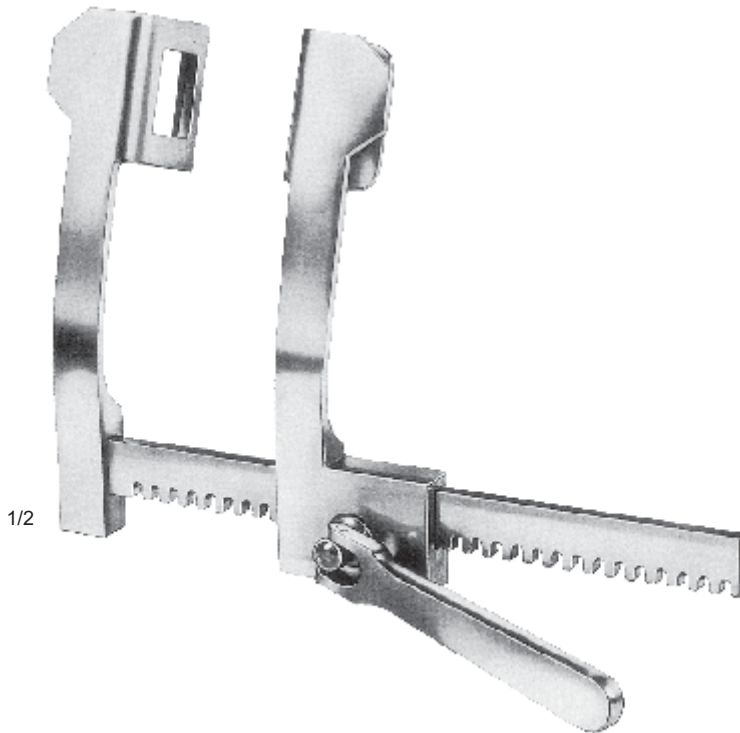

RIB SPREADERS

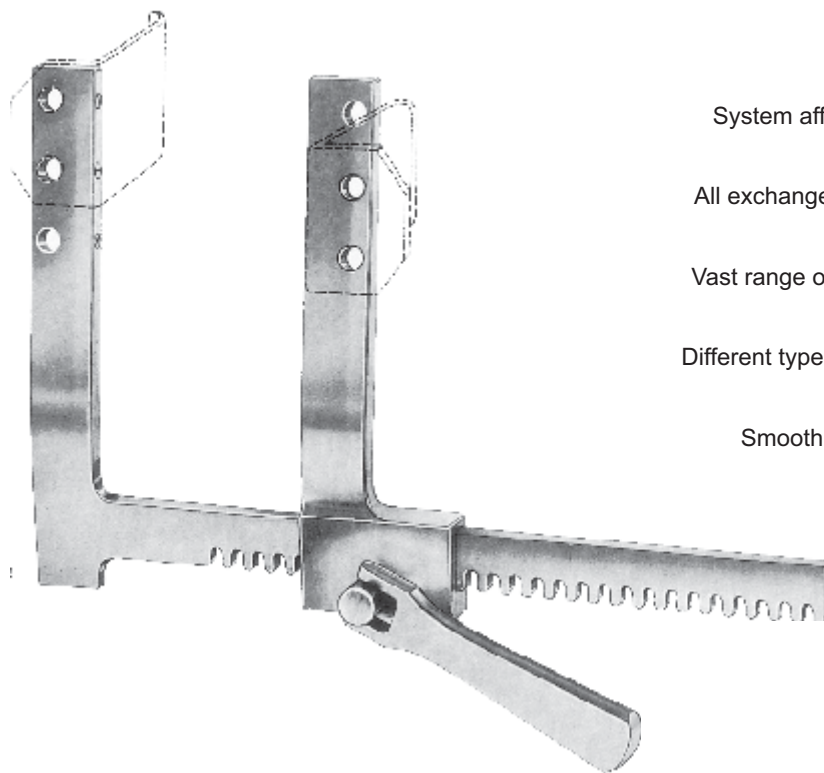

Advantages:

- System affording quick and problem free exchange of blades
- All exchangeable blades with instant locking plug-in system
- Vast range of fix and adapting exchangeable blades
- Different types of exchangeable blades can be fixed to either side
- Smooth surfaces, Sutures stay free
- Easy cleaning

FINOCCHIETTO

S9-18028
 Retractor, Small size
 with 3 pair of exchangeable blades

S9-18029
 Retractor, Small size only

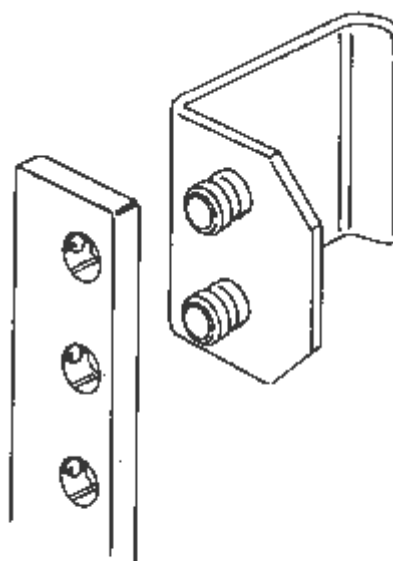



RIB SPREADERS

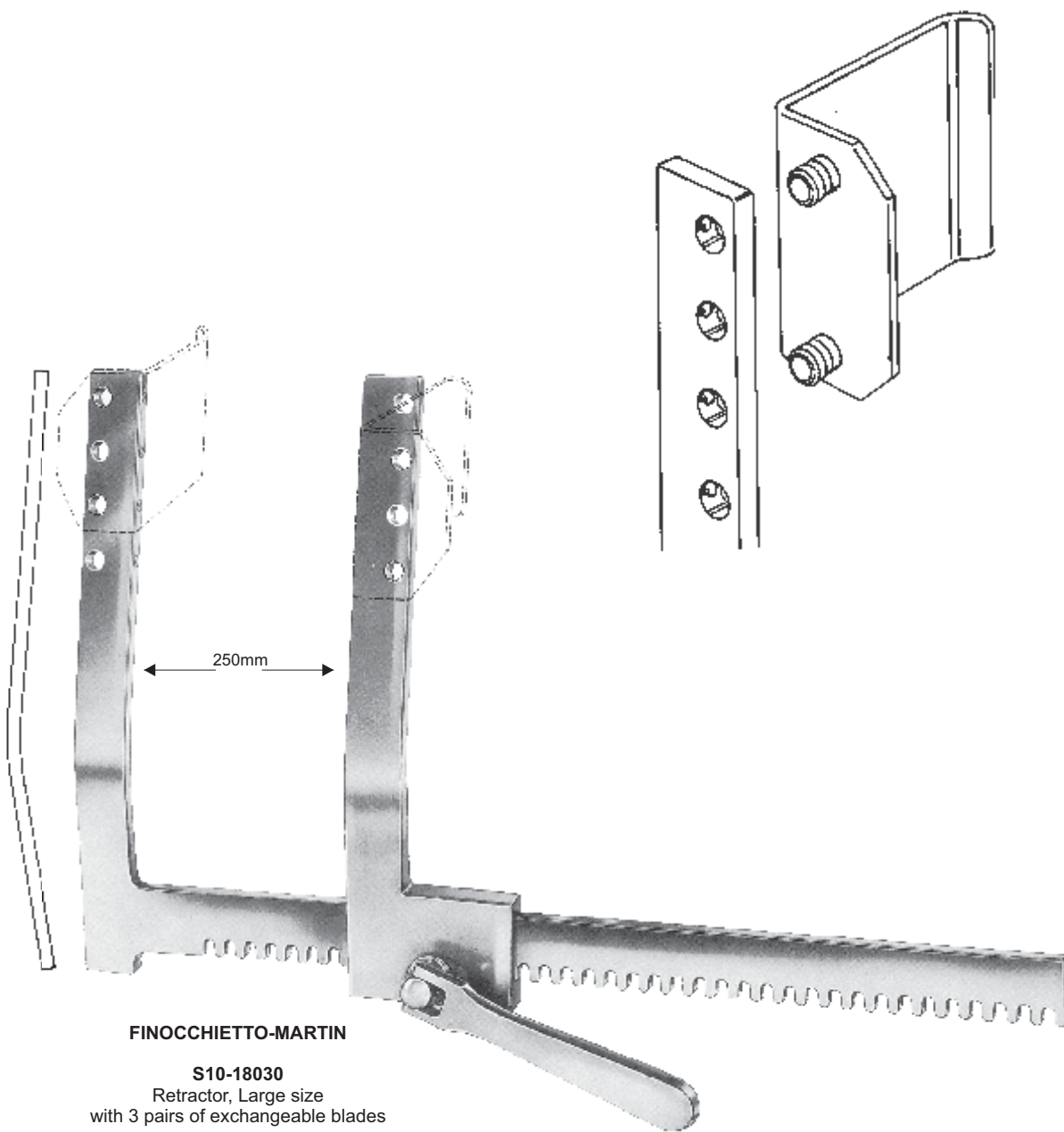

FINOCCHIETTO-MARTIN
S10-18030
Retractor, Large size
with 3 pairs of exchangeable blades

S10-18031
Retractor, Large size only





RIB SPREADERS

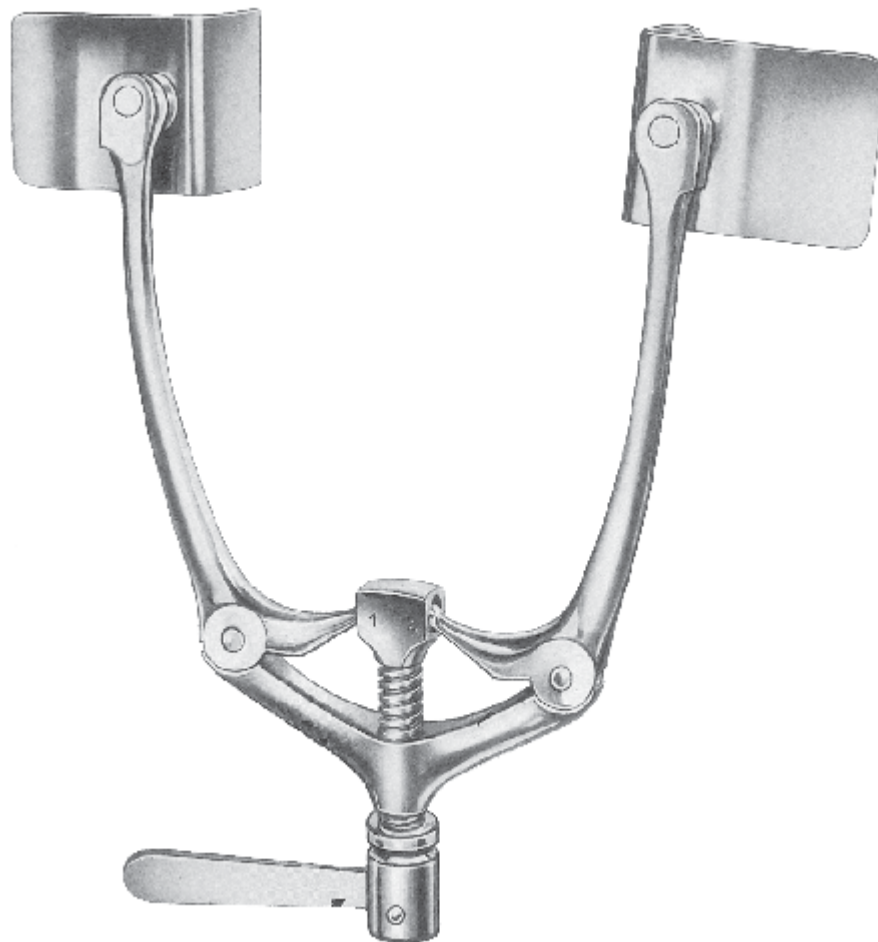

QUERVAIN
S11-18032

a	b	c
35mm	50mm	180mm



RIB SPREADERS

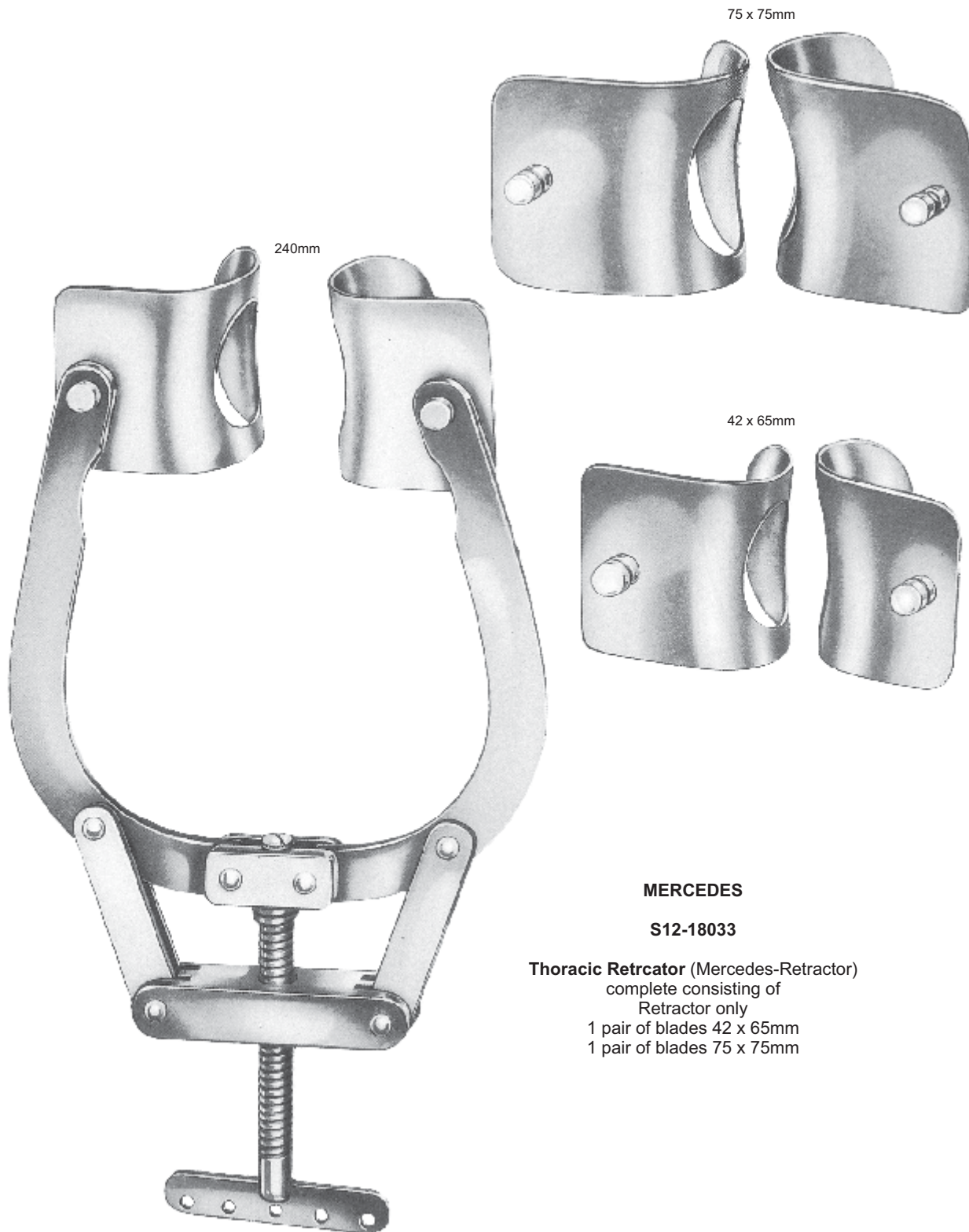

MERCEDES

S12-18033

Thoracic Retractor (Mercedes-Retractor)
complete consisting of
Retractor only
1 pair of blades 42 x 65mm
1 pair of blades 75 x 75mm



RIB SPREADERS



S13-18034
 190mm (7.1/2")



BAILEY-BABY
S13-18035
 140mm (5.1/2")

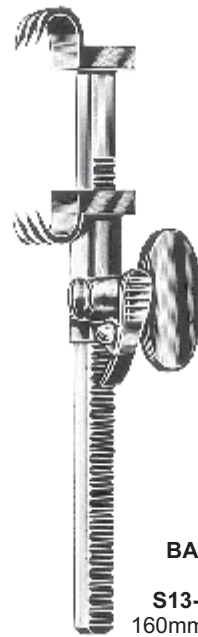

BAILEY
S13-18036
 160mm (6.1/4")



BAILEY GIBBON
S13-18037
 160mm (6.1/4")



ALLISON
S13-18038
 300mm (12")
S13-18039
 320mm (12.1/2")



ALLISON
S13-18040
 260mm (10.1/4")

**BRONCHUS FORCEPS
 LIGATURE FORCEPS**

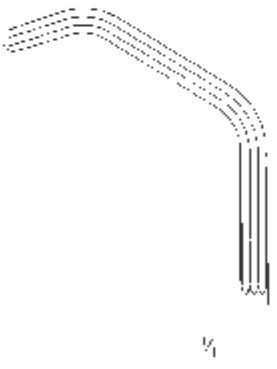

1/2

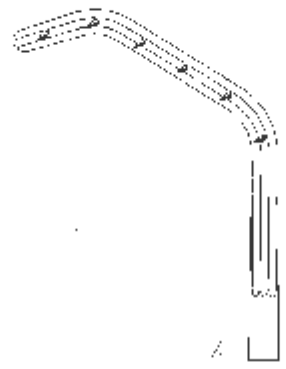

S14-18042

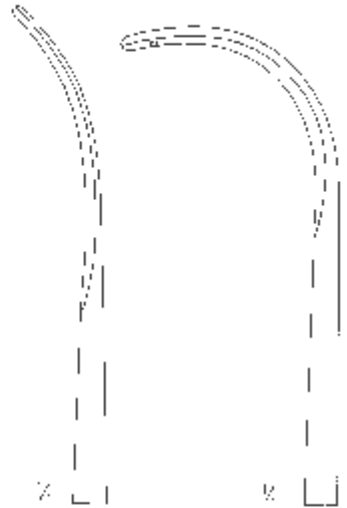

S14-18043

S14-18044



1/2

PRICE-THOMAS

S14-18041
 220mm (8.3/4")

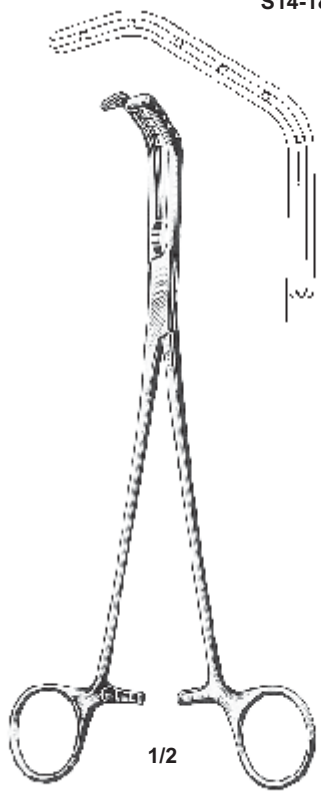

1/2

PRICE-THOMAS

S14-18042
 220mm (8.3/4")



1/2

SEMB

S14-18043
 240mm (9.1/2")

**TISSUE AND ORGAN
 HOLDING FORCEPS**

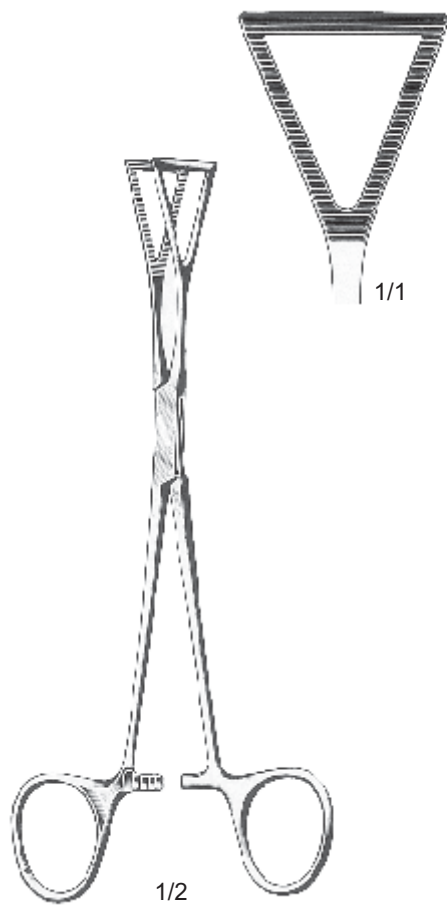

LOVELACE
 Straight

S15-18045
 200mm (8")

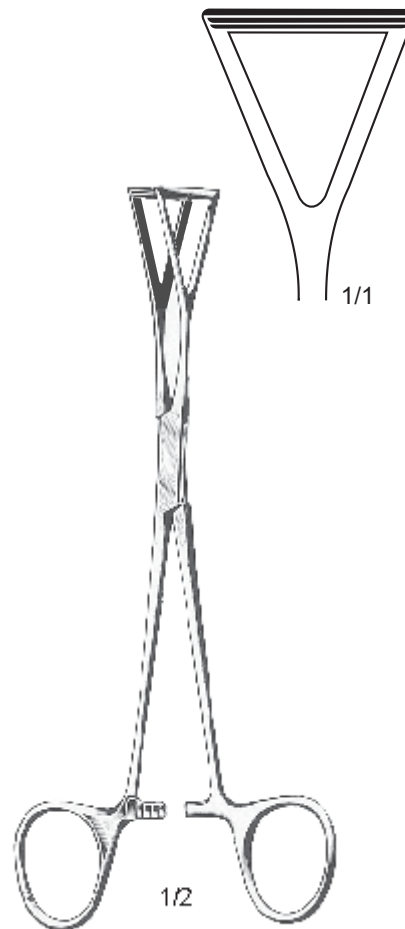

LOVELACE

S15-18046
 200mm (8")

ATRAUMA BULLDOG CLAMPS

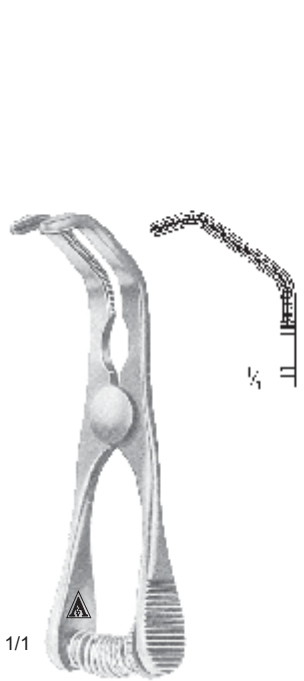

1/1

DE-BAKEY SATINSKY

S16-18047
 70mm (2.3/4")

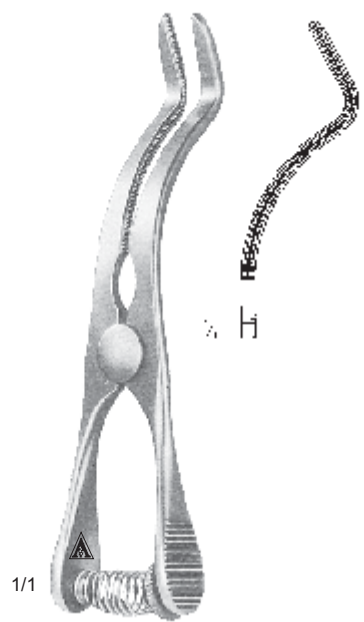

1/1

DE BAKEY-CAROTIS

S16-18048
 90mm (3.1/2")

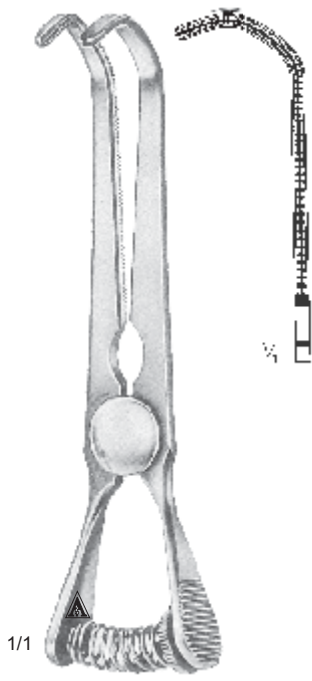

1/1

DE BAKEY SATINSKY

S16-18049
 100mm (4")

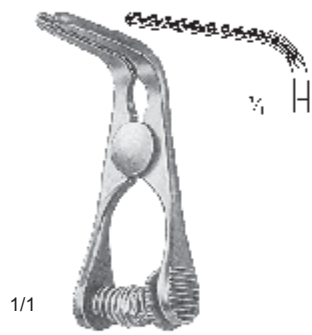

1/1

GLOVER

S16-18050
 50mm (2")

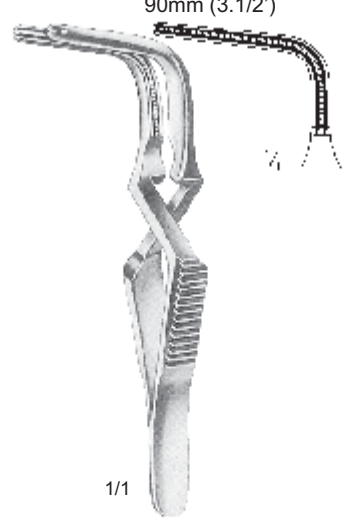

1/1

SANTULLI

S16-18051
 70mm (2.3/4")

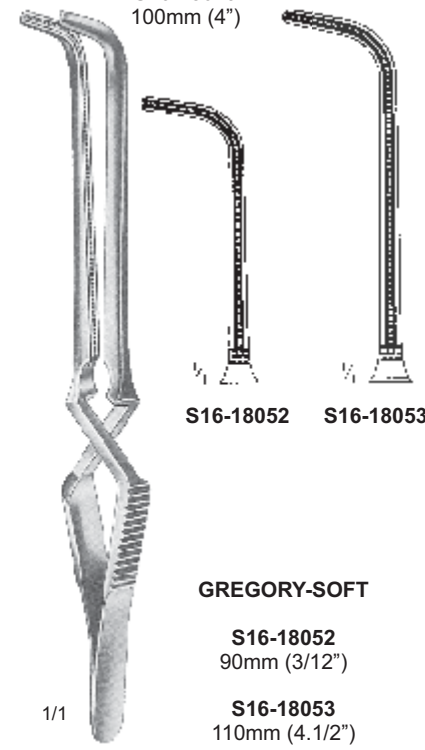

1/1

GREGORY-SOFT

S16-18052
 90mm (3/12")

S16-18053
 110mm (4.1/2")

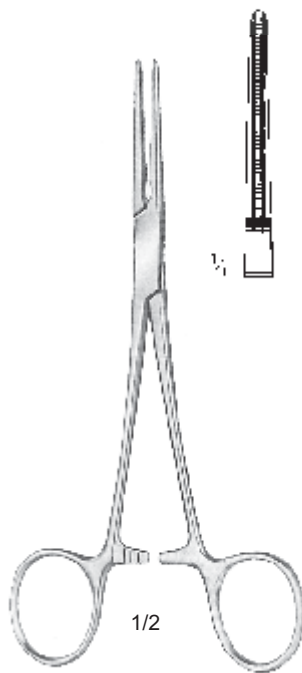

DE BAKEY-RANKIN
S17-18054
 Straight
 160mm (6.1/4")

S17-18055
 Curved
 160mm (6.1/4")

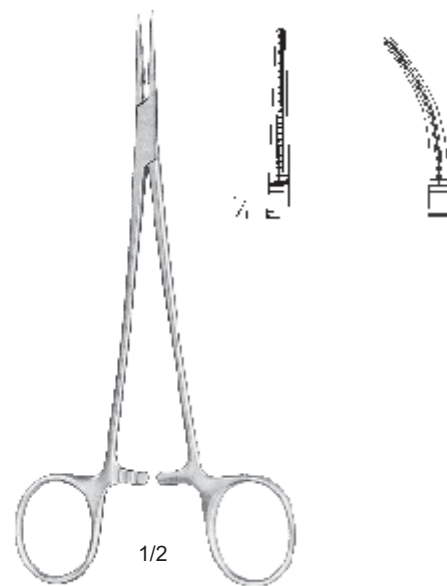

DE BAKEY-MOSQUITO
S17-18056
 Straight
 150mm (6")

Curved
 150mm (6")

**ATRAUMA CARDIOVASCULAR
 FORCEPS**



1/2

OCHSNER
S18-18057
 235mm (9.1/4")



1/1



1/2

DIETRICH
S18-18058
 210mm (8.1/4")

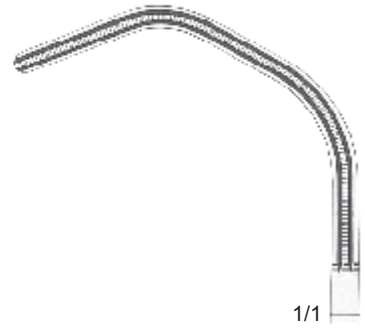

1/1

**ATRAUMA CARDIOVASCULAR
 FORCEPS**



1/2

DALE

S19-18059
 185mm (7")



1/1



1/2

DALE



1/1

S19-18060
 170mm (6.1/2")



1/1

S19-18061
 175mm (7")

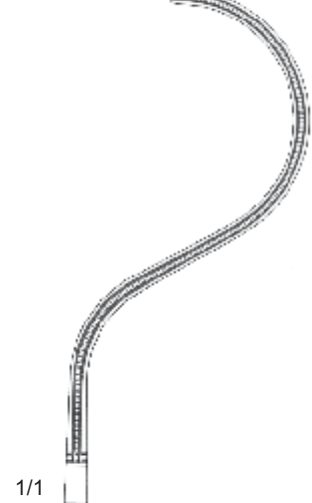

1/1

S19-18062
 185mm (7.1/4")

**ATRAUMA CARDIOVASCULAR
 FORCEPS**

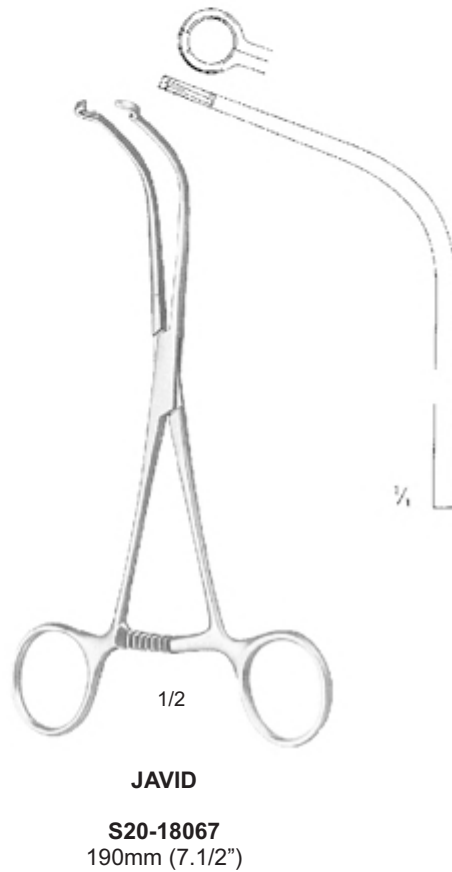
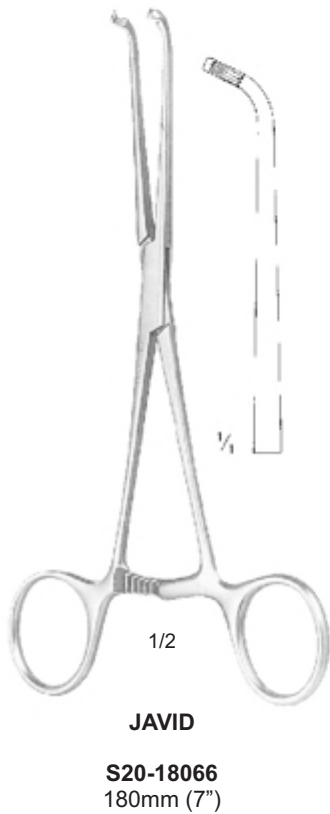

**ATRAUMA CARDIOVASCULAR
 FORCEPS**

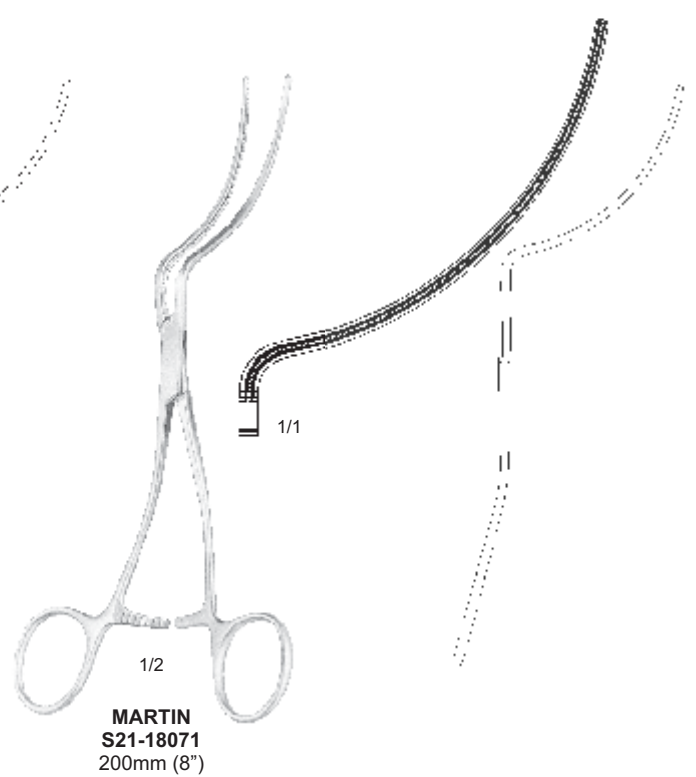
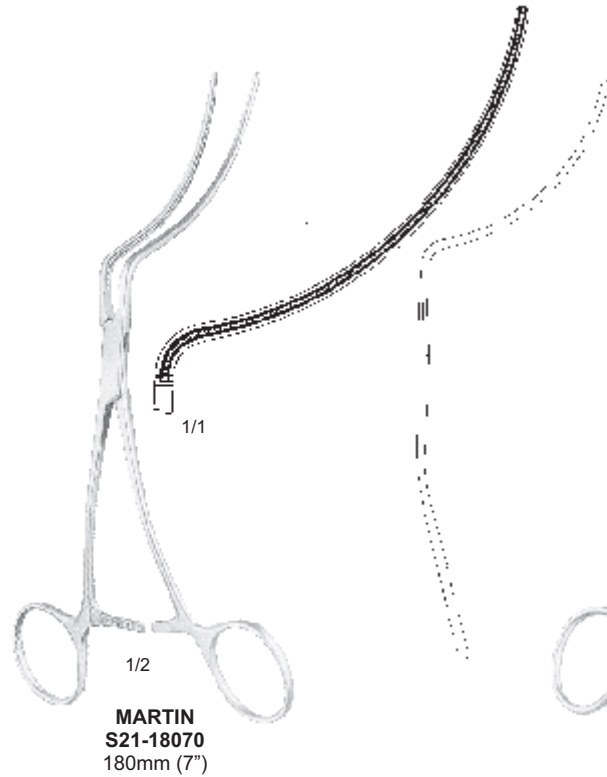
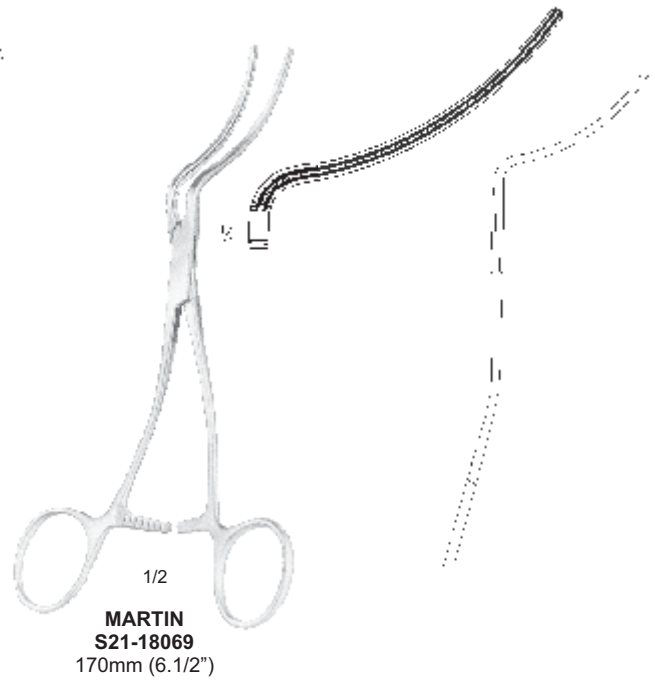
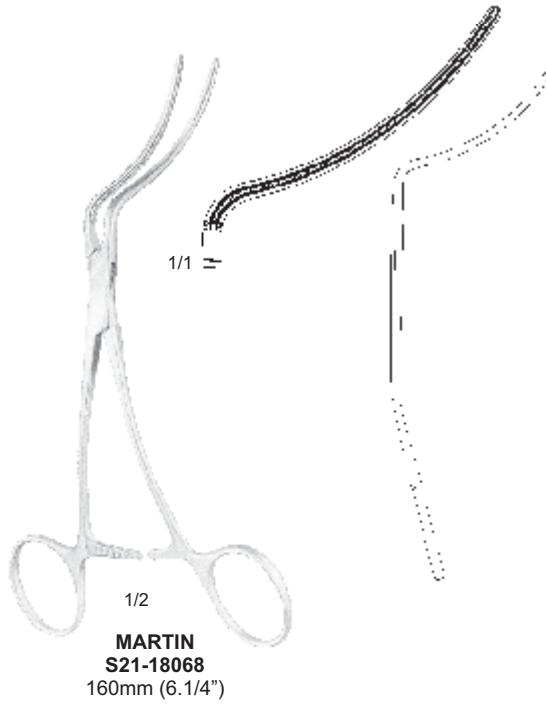



VASCULAR MEASURING DEVICE

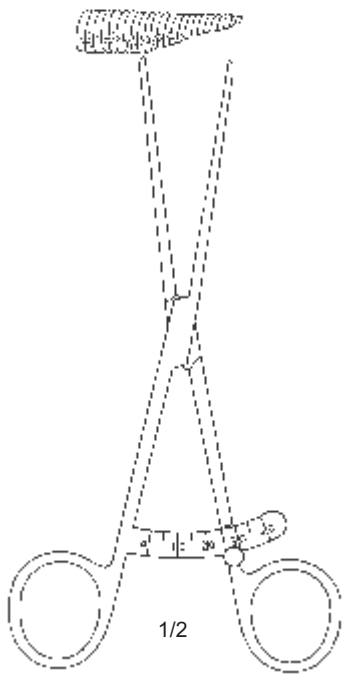
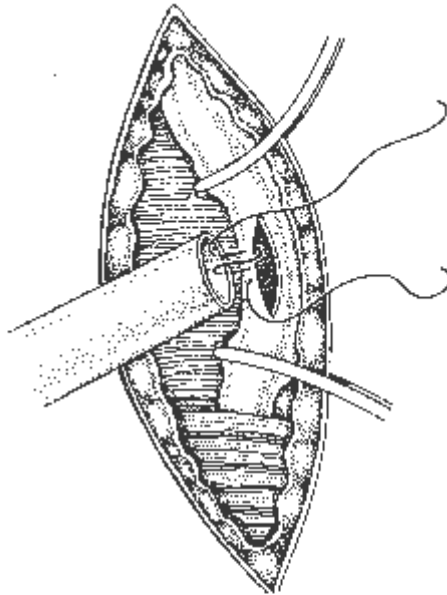

MEASURING FORCEPS

S22-18072
Straight - 180mm (7")

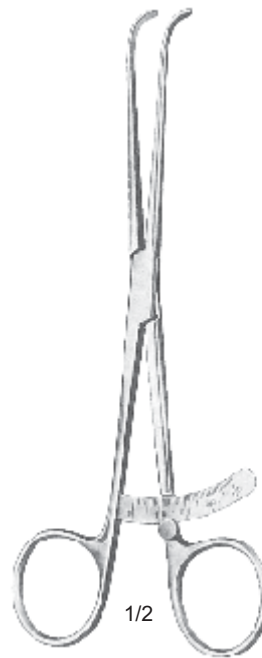

MEASURING FORCEPS

S22-18073
Straight - 180mm (7")



**ATRAUMA
CARDIOVASCULAR FORCEPS**

Cooley type caval occlusion used during cardiopulmonary By-Pass for occluding the vena caval. The tips of the instrument permit flow indwelling cannula

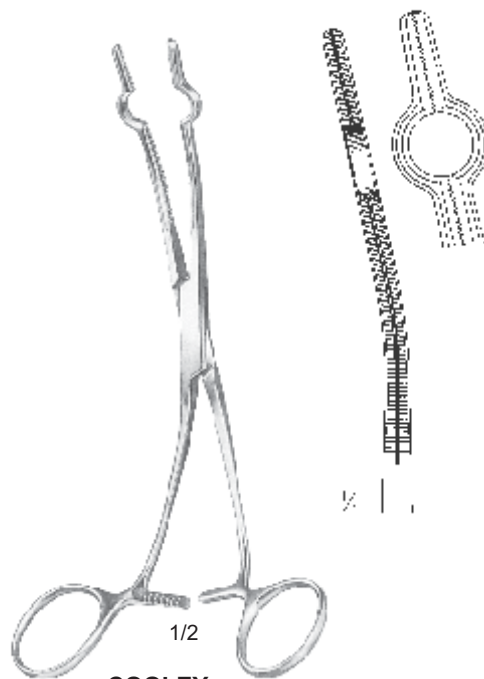

COOLEY

S23-18074
child

S23-18075
adult

ATRAUMA TISSUE FORCEPS

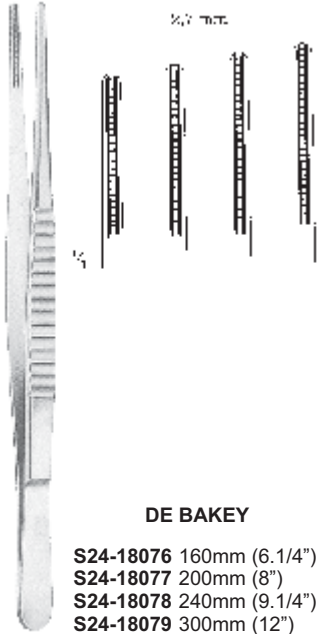

DE BAKEY

- S24-18076 160mm (6.1/4")
- S24-18077 200mm (8")
- S24-18078 240mm (9.1/4")
- S24-18079 300mm (12")



DE BAKEY

- S24-18080 160mm (6.1/4")
- S24-18081 200mm (8")
- S24-18082 240mm (9.1/4")

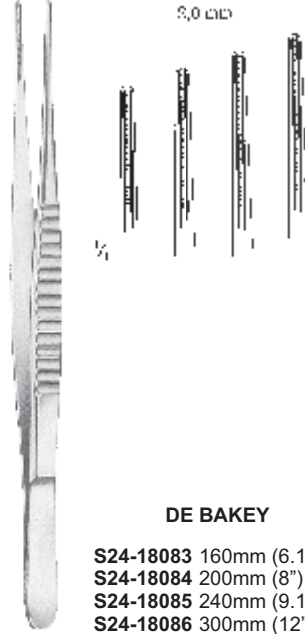

DE BAKEY

- S24-18083 160mm (6.1/4")
- S24-18084 200mm (8")
- S24-18085 240mm (9.1/4")
- S24-18086 300mm (12")

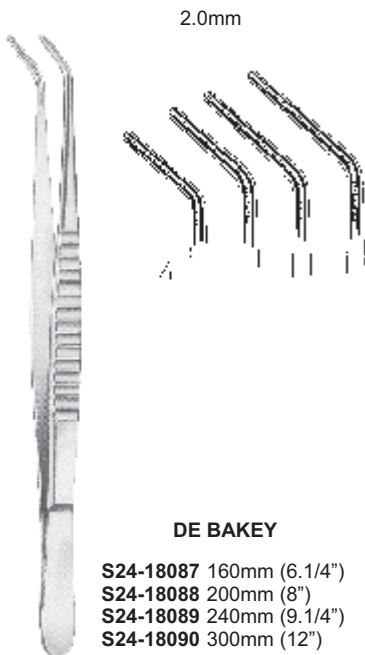

DE BAKEY

- S24-18087 160mm (6.1/4")
- S24-18088 200mm (8")
- S24-18089 240mm (9.1/4")
- S24-18090 300mm (12")



DE BAKEY

- S24-18091 160mm (6.1/4")
- S24-18092 200mm (8")
- S24-18093 240mm (9.1/4")
- S24-18094 300mm (12")



COOLEY

- S24-18095 160mm (6.1/4")
- S24-18096 200mm (8")

ATRAUMA BULLDOG CLAMPS



1/1

DEBAKEY BULLDOG CLAMPS



1/1

S25-18097
75mm (3")



1/1

S25-18098
85mm (3.1/2")



1/1

S25-18099
105mm (4.1/4")



1/1

S25-18100
120mm (4.3/4")



1/1

DEBAKEY BULLDOG CLAMPS



1/1

S25-18101
70mm (2.3/4")



1/1

S25-18102
80mm (3.1/4")



1/1

S25-18103
100mm (4")



1/1

S25-18104
115mm (4.3/4")

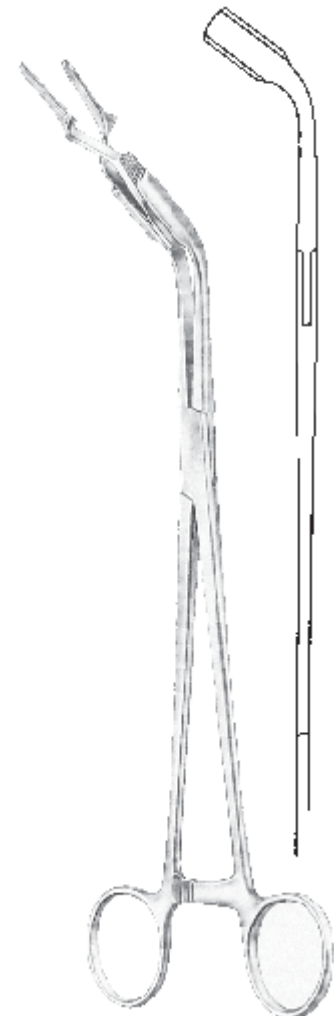

APPLYING FORCEPS
S25-18105
230mm (9")

ATRAUMA CARDIOVASCULAR FORCEPS

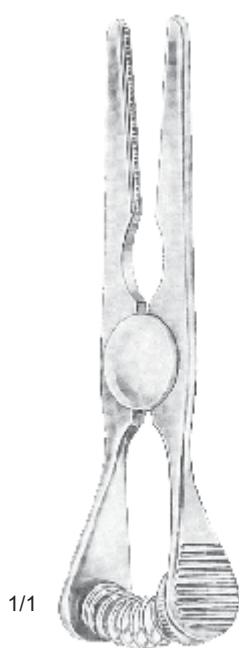

1/1

GLOVER



1/1

S26-18106
 70mm (2.3/4")



1/1

S26-18107
 80mm (3.1/4")



1/1

S26-18108
 90mm (3.1/2")



1/1

S26-18109
 110mm (4.1/2")



1/1

GLOVER



1/1

S26-18110
 60mm (2.1/2")



1/1

S26-18111
 75mm (3")



1/1

S26-18112
 85mm (3.1/2")



1/1

S26-18113
 105mm (4.1/2")

**ATRAUMA CARDIOVASCULAR
 FORCEPS**



S27-18114
 210mm (8.1/4")



S27-18115
 220mm (8.3/4")



S27-18116
 210mm (8.1/4")



S27-18117
 220mm (8.3/4")



S27-18118
 210mm (8.1/4")



S27-18119
 220mm (8.3/4")



**ATRAUMA CARDIOVASCULAR
 FORCEPS**



S28-18120
 220mm (8.3/4")

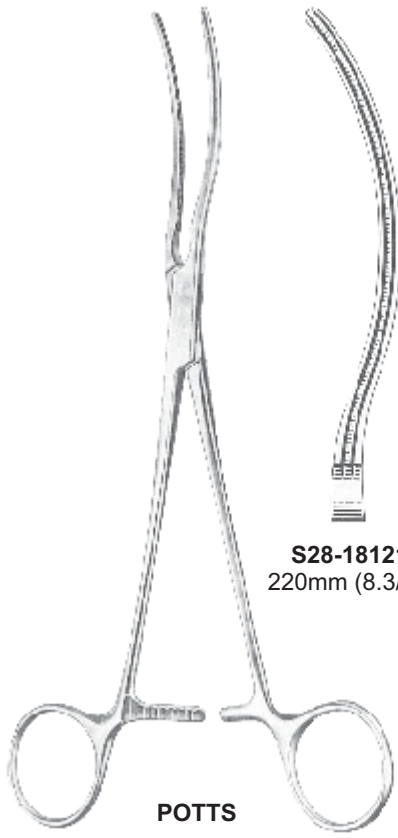

S28-18121
 220mm (8.3/4")



S28-18122
 190mm (7.1/2")



S28-18123
 230mm (9")

ATRAUMA CARDIOVASCULAR FORCEPS

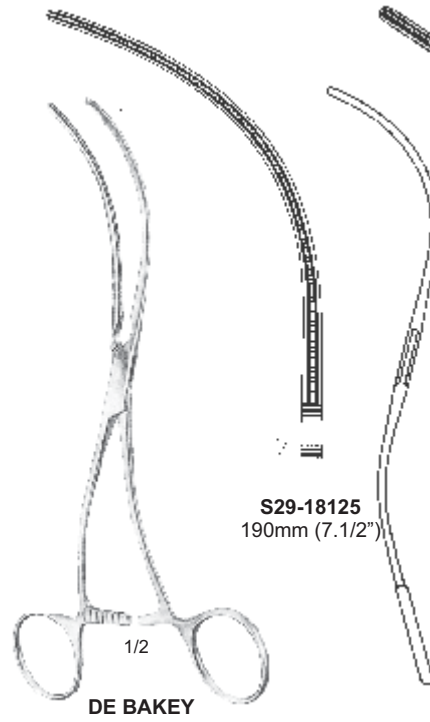
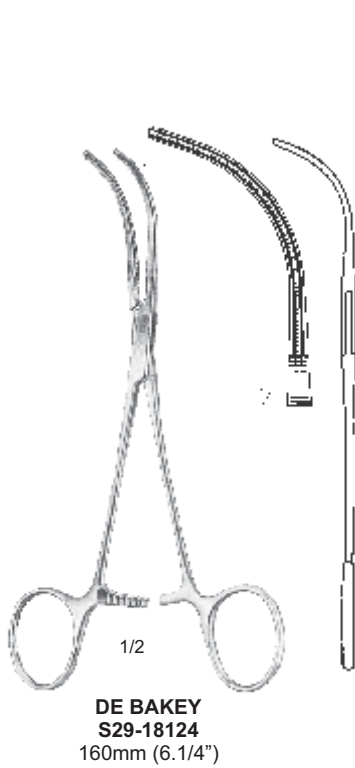

S29-18125
 190mm (7.1/2")

S29-18126
 200mm (8")

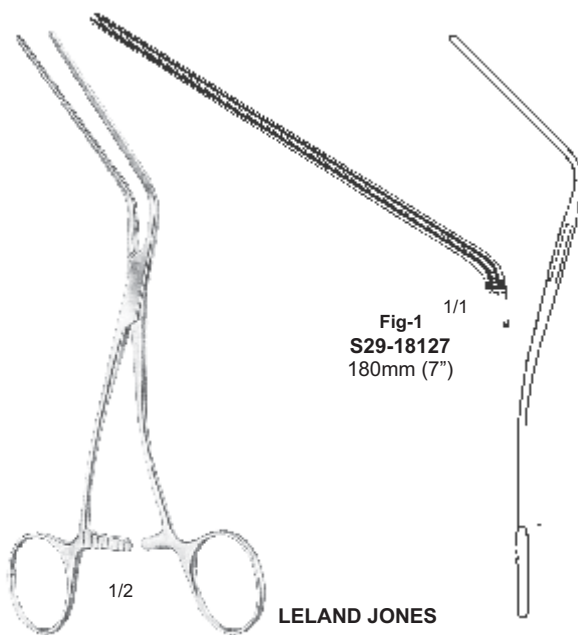

Fig-1
 S29-18127
 180mm (7")

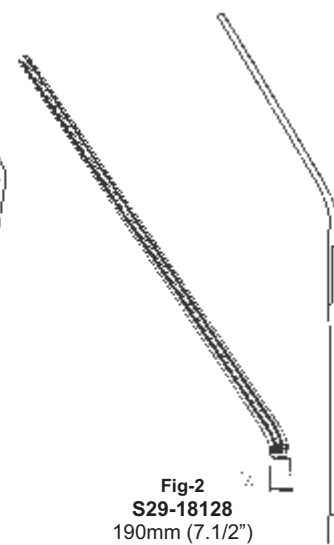

Fig-2
 S29-18128
 190mm (7.1/2")

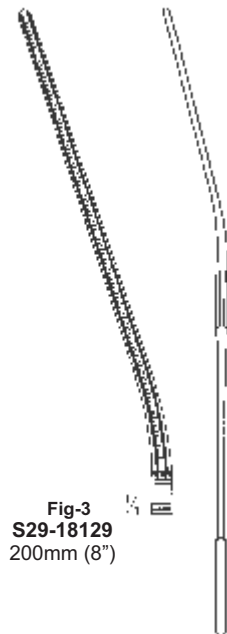

Fig-3
 S29-18129
 200mm (8")

**ATRAUMA CARDIOVASCULAR
 FORCEPS**



1/2

BAINBRIDGE



1/1

S30-18130
 150mm (6")



1/1

S30-18131
 180mm (7")



1/2

BAINBRIDGE



1/1

S30-18132
 150mm (6")



1/1

S30-18133
 180mm (7")



1/2

DE BAKEY
S30-18134
 200mm (8")



1/1

■ ■ ■ ■ ■
**ATRAUMA CARDIOVASCULAR
 FORCEPS**



1/2

ANEURYSM CLAMP



1/1

S31-18135
 260mm (10.1/4")

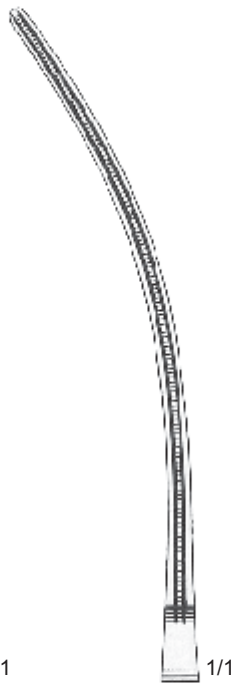

1/1

S31-18136
 270mm (10.1/2")

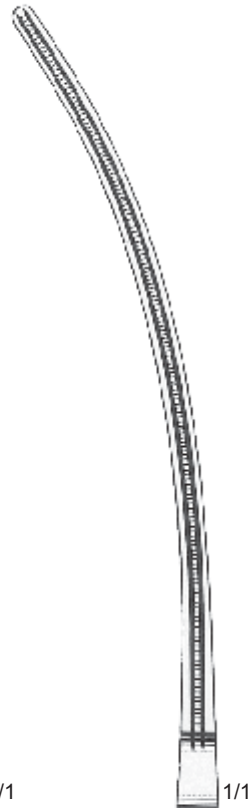

1/1

S31-18137
 310mm (12.1/4")

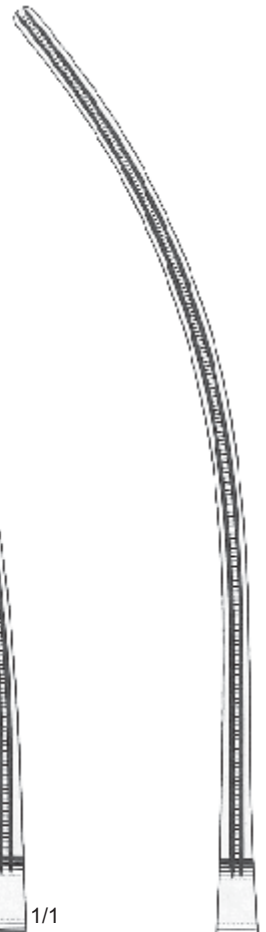

1/1

S31-18138
 330mm (13")





ATRAUMA CARDIOVASCULAR FORCEPS

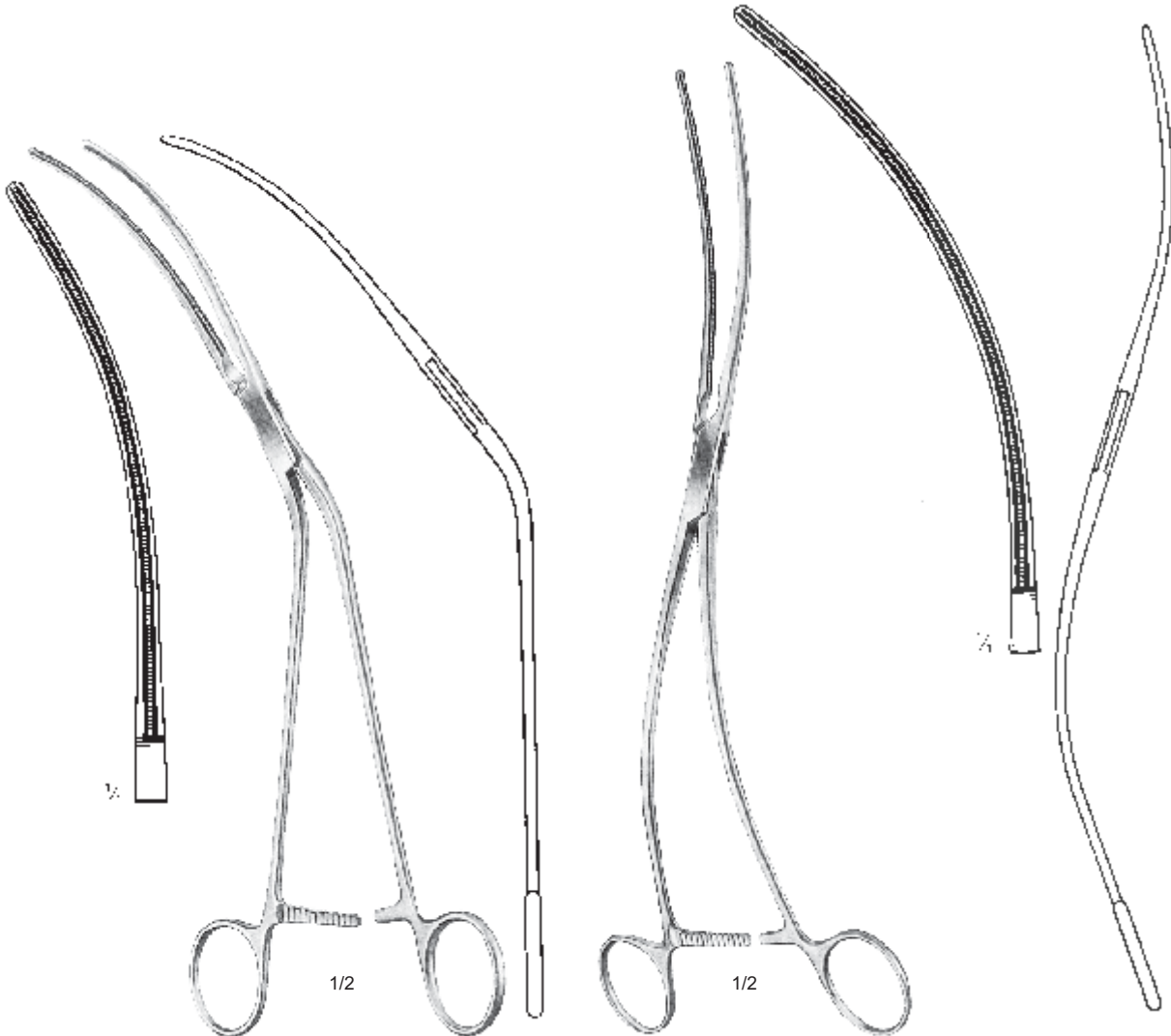

DE BAKAY
S32-18139
280mm (11")

DE BAKAY
S32-18140
300mm (11.3/4")

**ATRAUMA CARDIOVASCULAR
 FORCEPS**

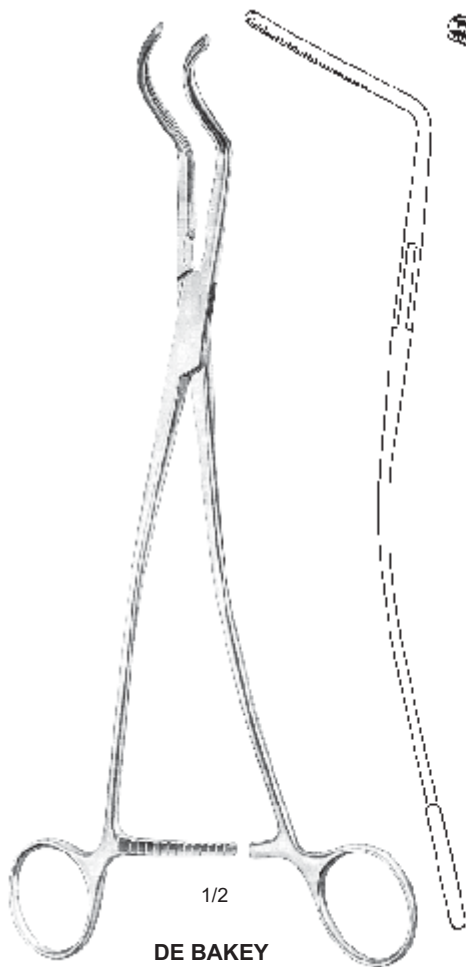

1/2
DE BAKEY
S33-18141
 27cm (10.1/2")

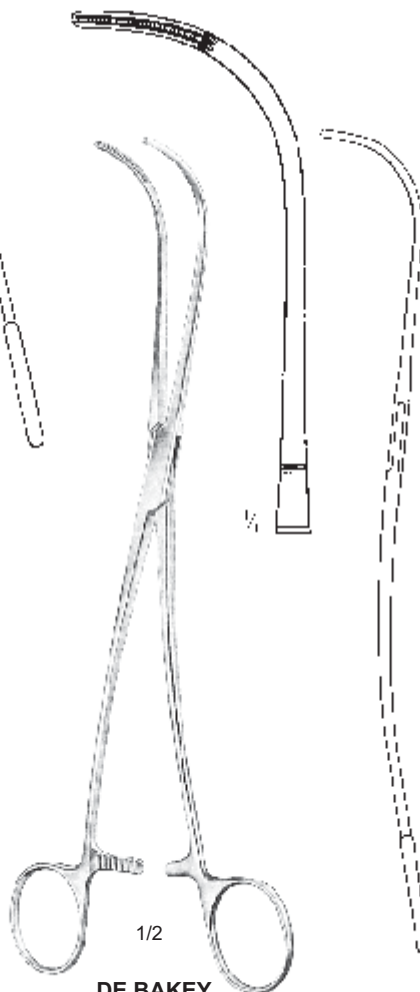
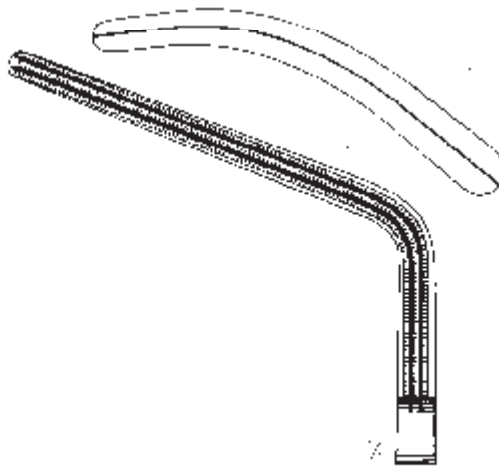

1/2
DE BAKEY
S33-18142
 240mm (9.1/2")

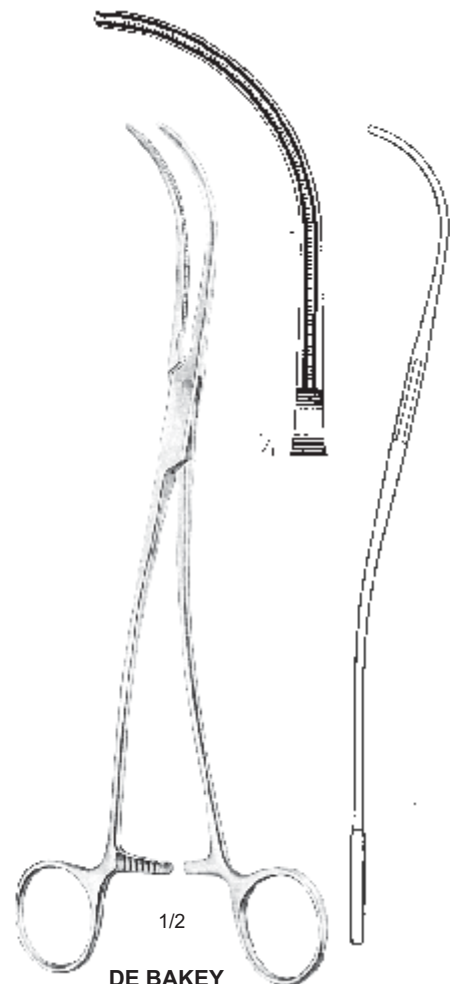

1/2
DE BAKEY
S33-18143
 240mm (9.1/2")

**ATRAUMA CARDIOVASCULAR
 FORCEPS**

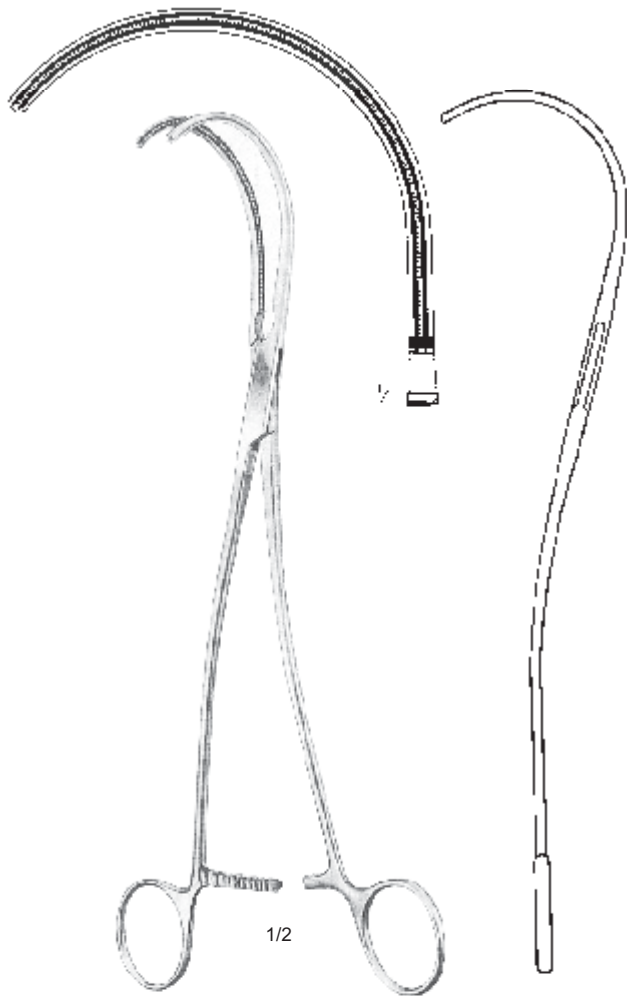

1/2
DE BAKKEY
S34-18144
 260mm (10")

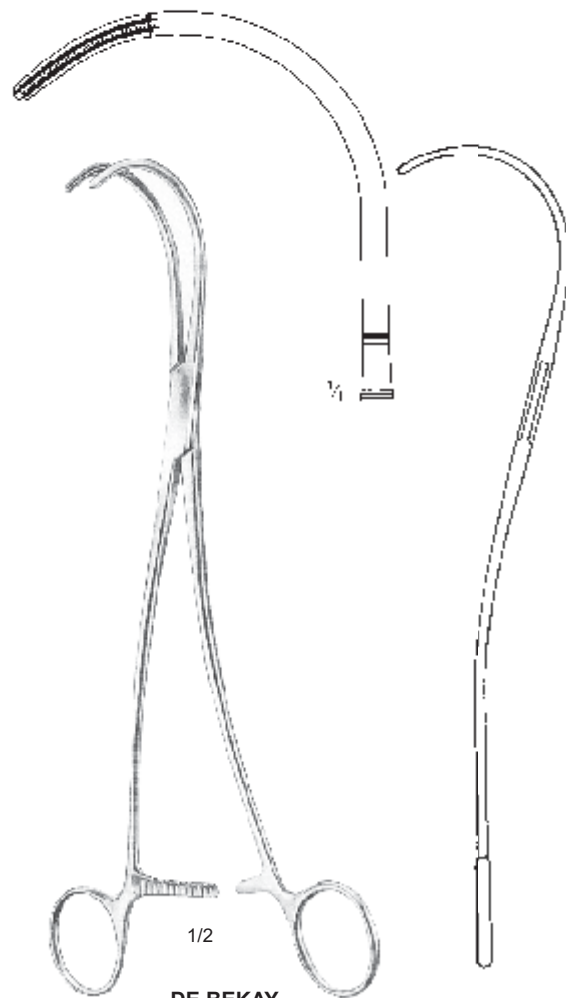

1/2
DE BEKAY
S34-18145
 250mm (10")

■ ■ ■ ■ ■
**ATRAUMA CARDIOVASCULAR
 FORCEPS**

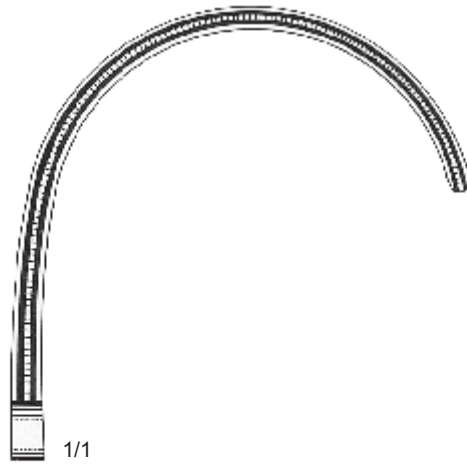

1/1

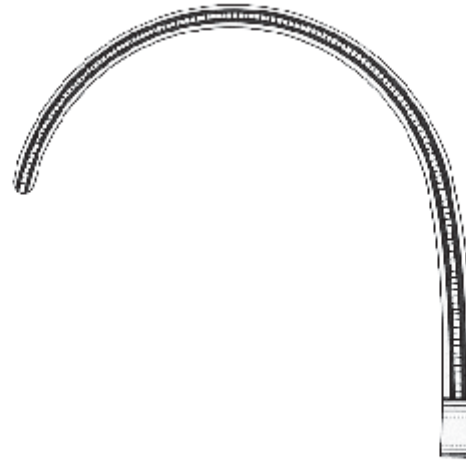

1/1



1/2

WEBER
S35-18146
 260mm (10.1/4")
 Left



1/2

WEBER
S35-18147
 260mm (10.1/4")
 Right



ATRAUMA CARDIOVASCULAR FORCEPS

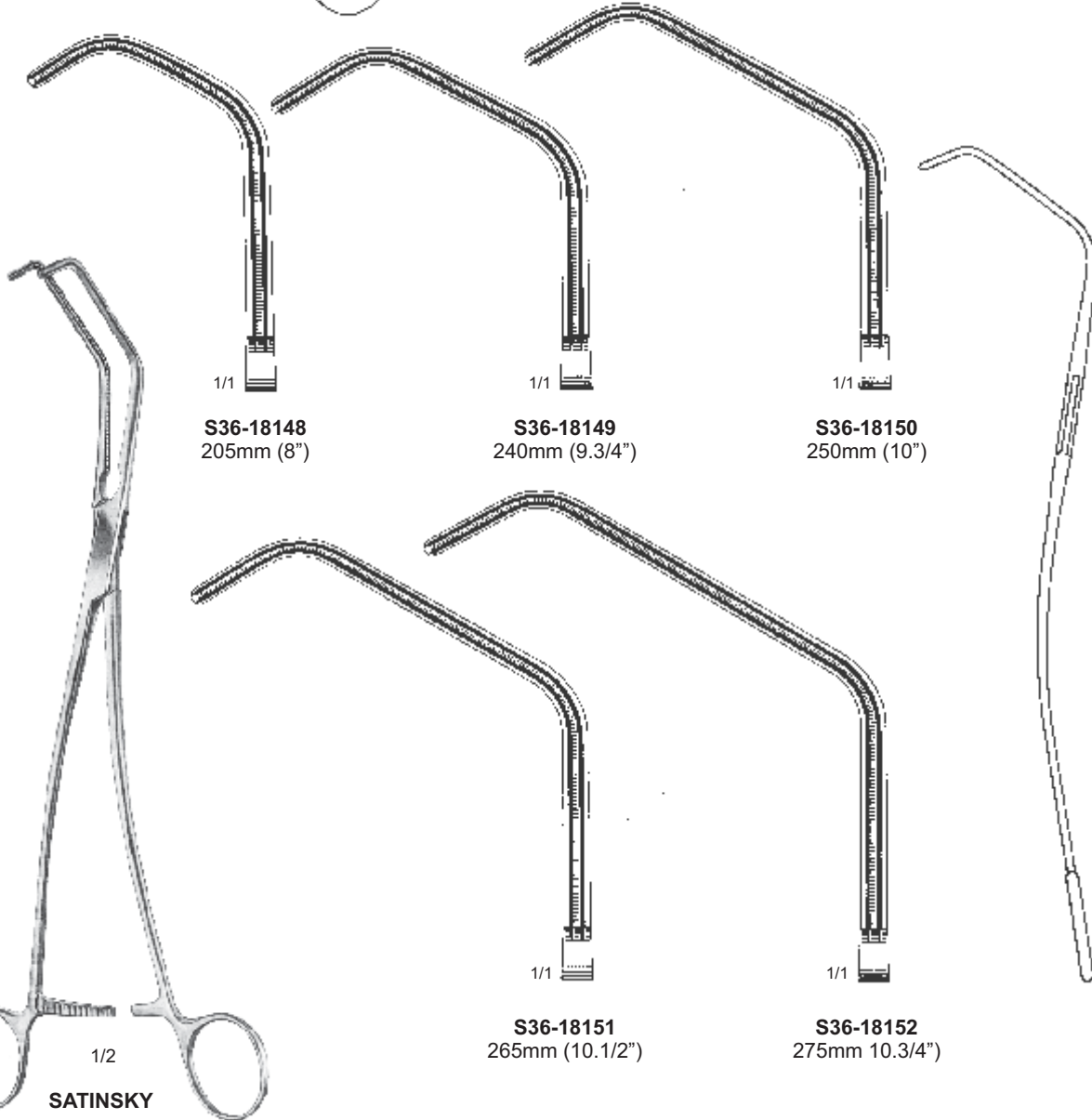
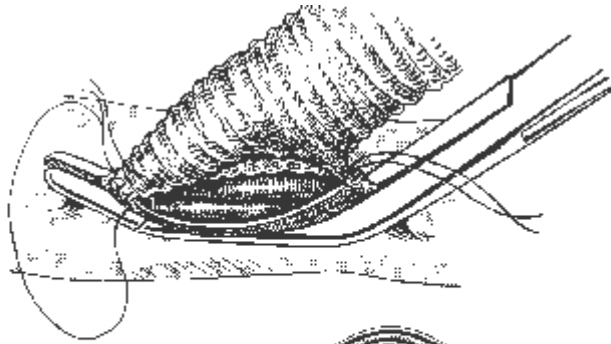

**ATRAUMA CARDIOVASCULAR
 FORCEPS**

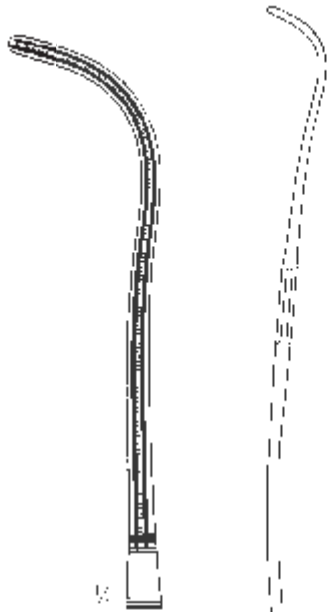

S37-18153
 240mm (9.1/2")

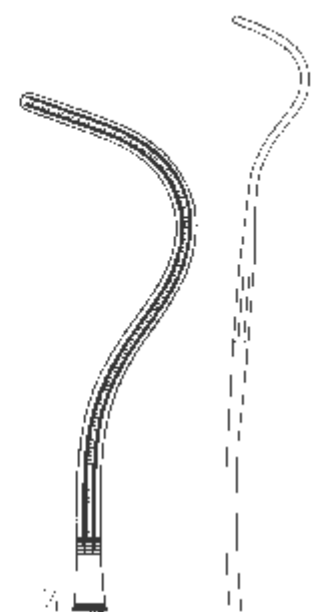

S37-18154
 240mm (9.1/2")



S37-18155
 240mm (9.1/2")

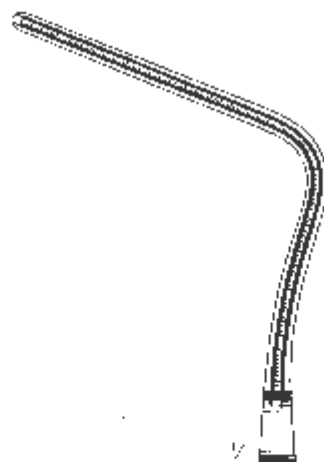

S37-18156
 240mm (9.1/2")

**ATRAUMA CARDIOVASCULAR
 FORCEPS**

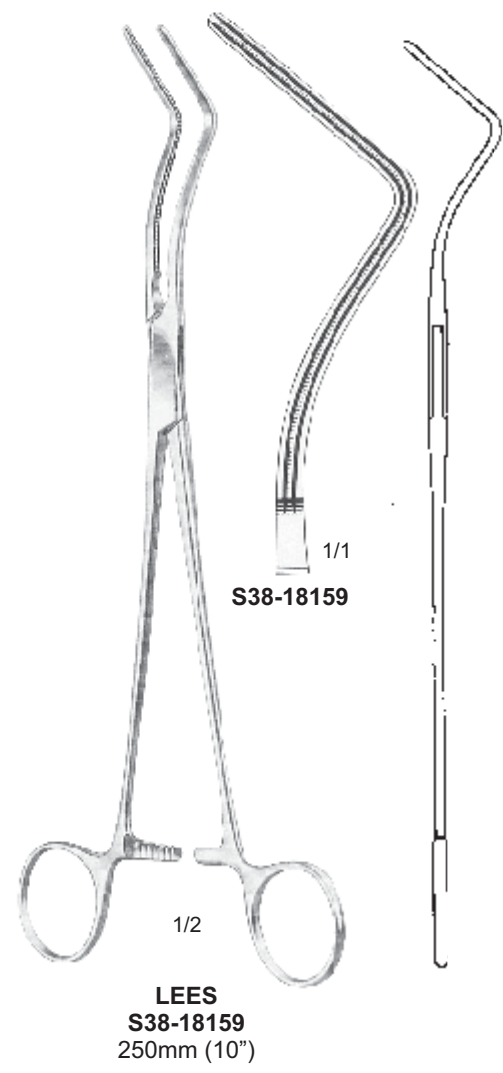
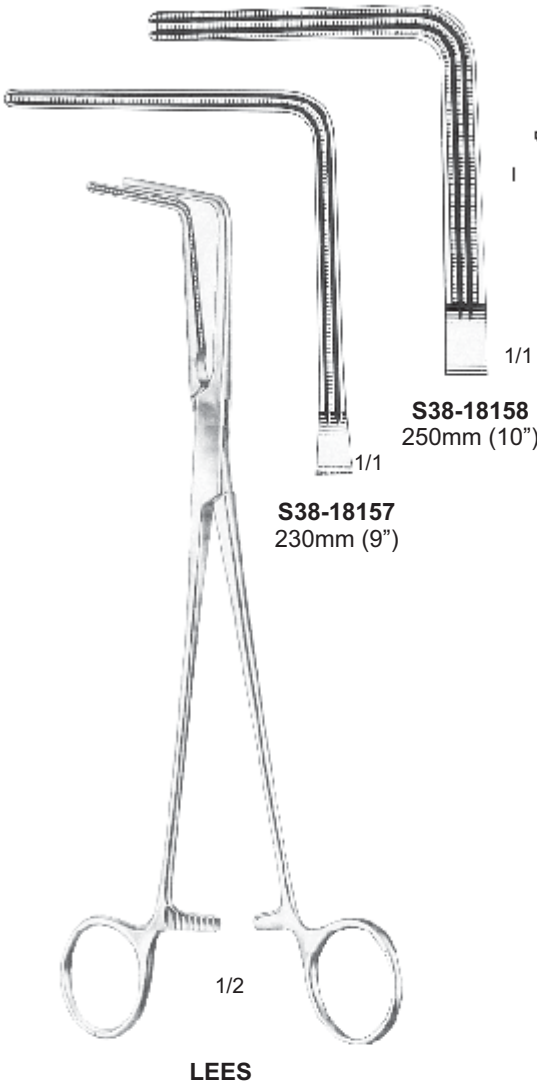

**ATRAUMA CARDIOVASCULAR
 FORCEPS**



1/2

LAMBERT - KAY

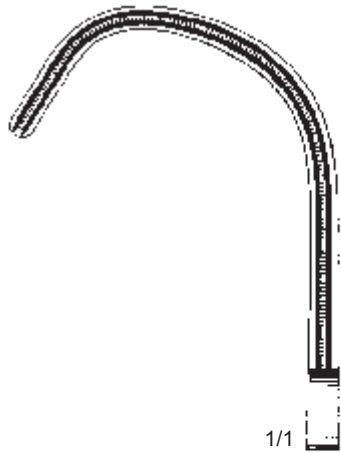

1/1

S39-18160

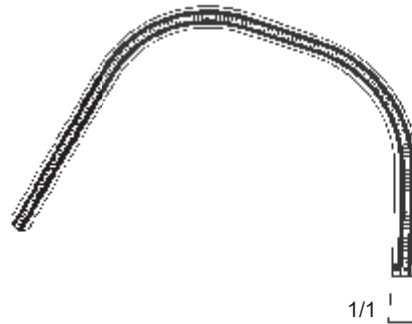

1/1

S39-18161

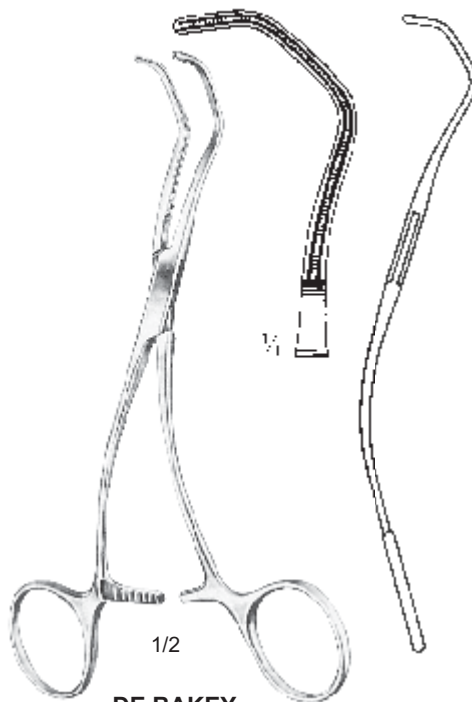
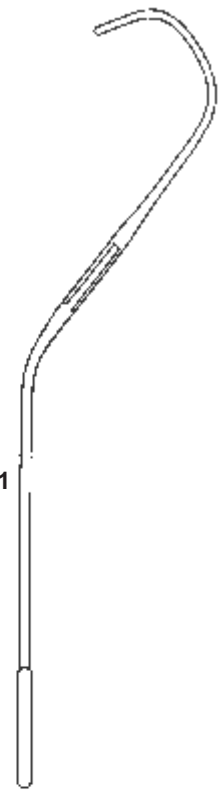

1/2

**DE BAKEY
 S39-18162
 170mm (6.3/4")**



ATRAUMA CARDIOVASCULAR FORCEPS



S40-18163
180mm (7")

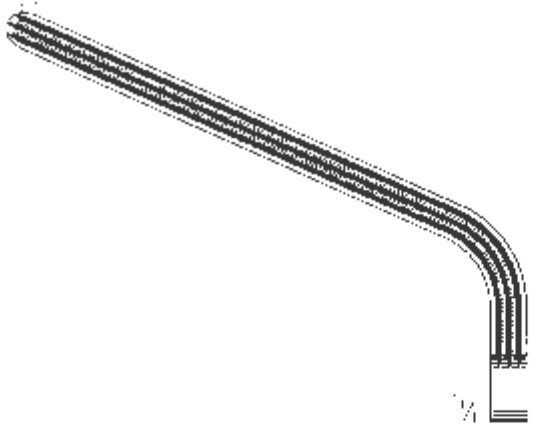

S40-18164
200mm (8")

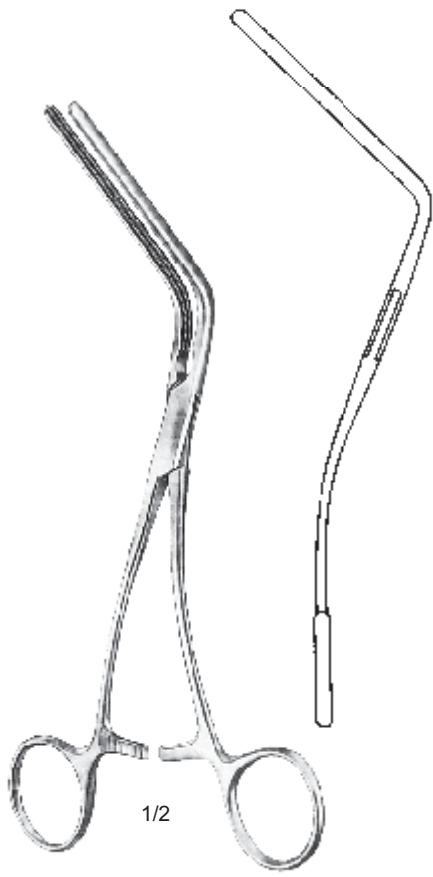

MORRIS DE BAKEY

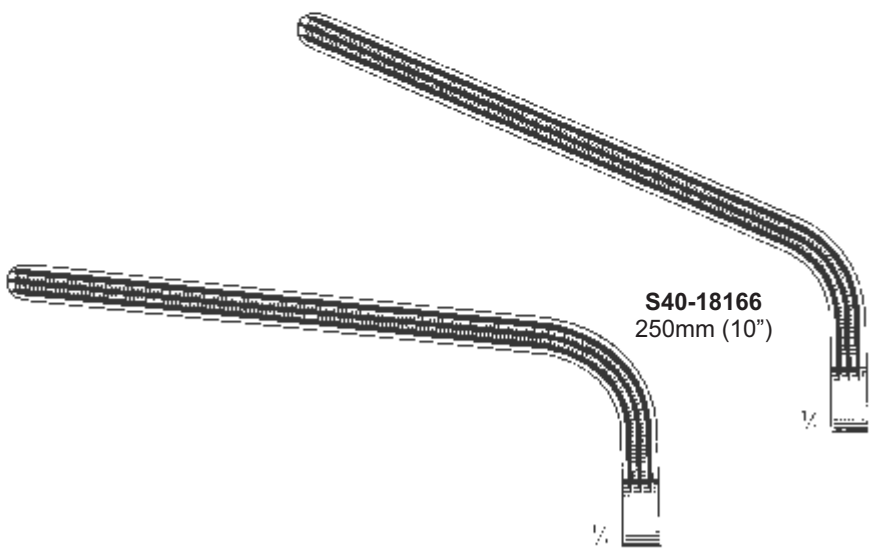

S40-18166
250mm (10")

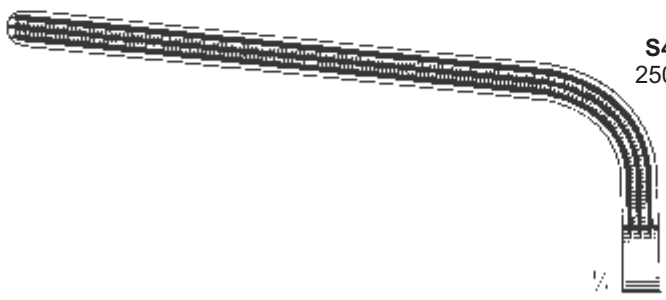

S40-18165
230mm (9")



**ATRAUMA CARDIOVASCULAR
 FORCEPS**



1/2

DE BAKEY BAHNSON

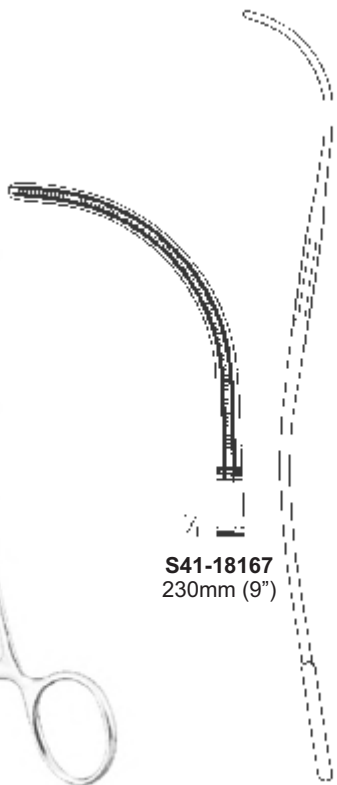

S41-18167
 230mm (9")

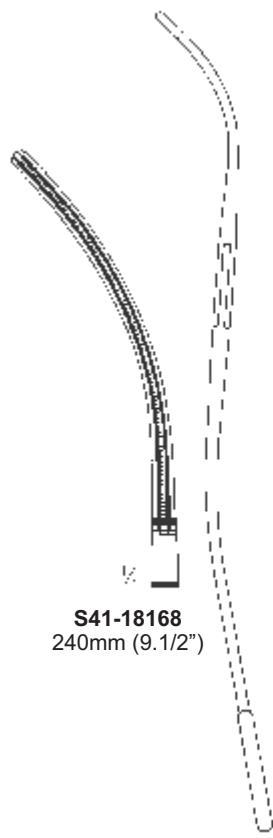

S41-18168
 240mm (9.1/2")

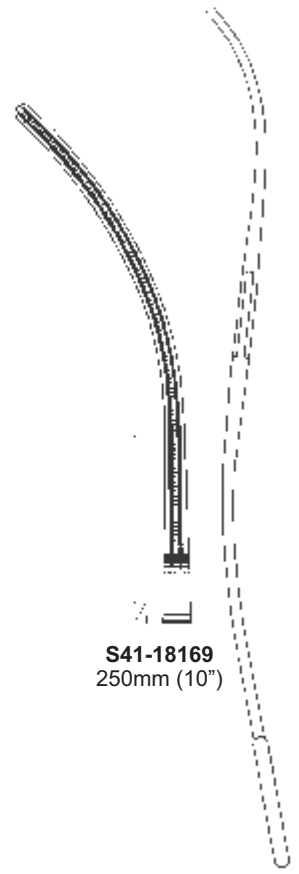

S41-18169
 250mm (10")

**ATRAUMA CARDIOVASCULAR
 FORCEPS**



S42-18170
 215mm (8.1/2")



S42-18171
 230mm (9")



S42-18172
 270mm (10.1/2")



S42-18173
 315mm (12.1/2")



S42-18174
 215mm (8.1/2")



S42-18175
 230mm (9")



S42-18176
 270mm (10.1/2")



S42-18177
 315mm (12.1/2")

**ATRAUMA CARDIOVASCULAR
 FORCEPS**

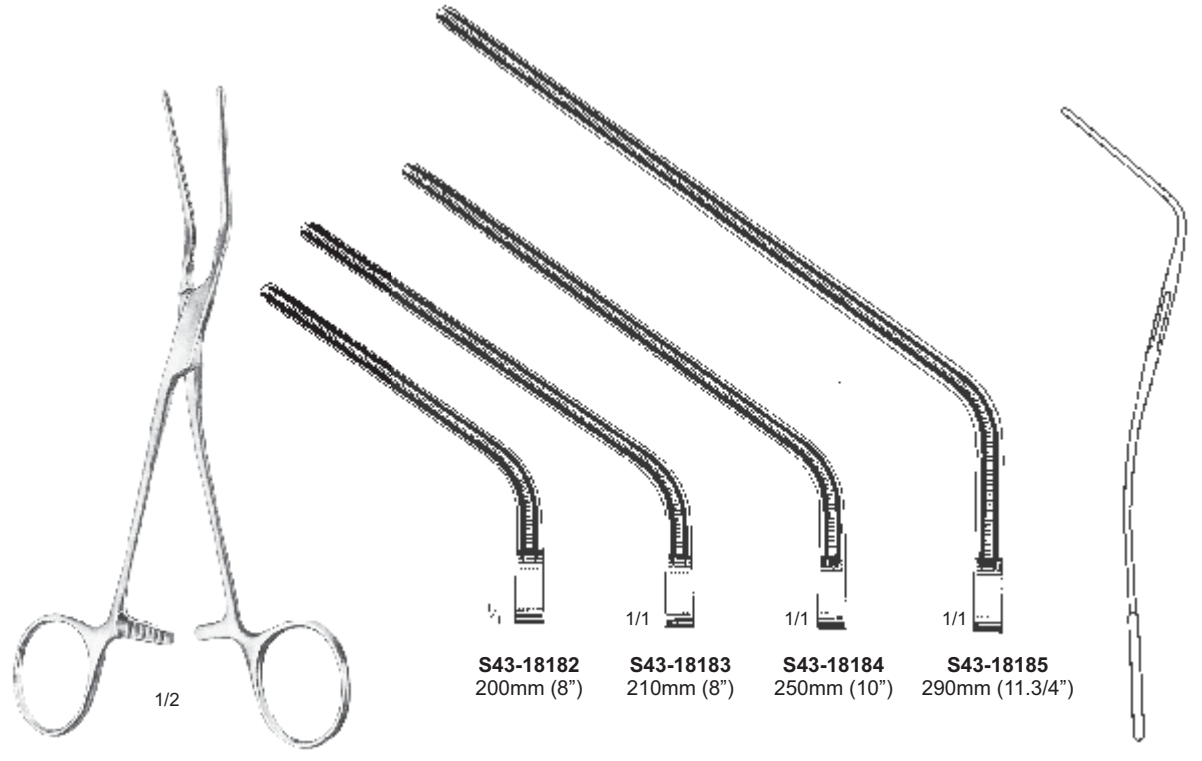
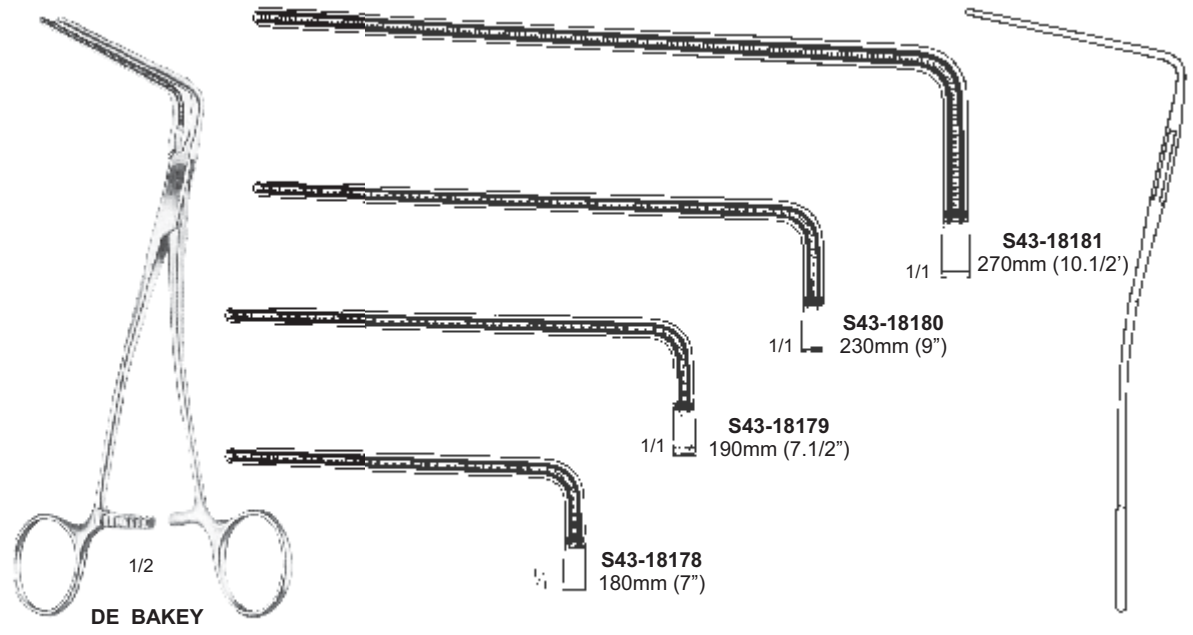

INSTRUMENTS

ATRAUMA HEMOSTATIC FORCEPS



DE BAKEY PEAN

DE - BAKEY PEAN
S44-18186
 120mm (4.3/4")



1/1
S44-18187
 140mm (5.1/2")



1/1
S44-18188
 160mm (6.1/4")



1/1
S44-18189
 180mm (7")



1/1
S44-18190
 200mm (8")

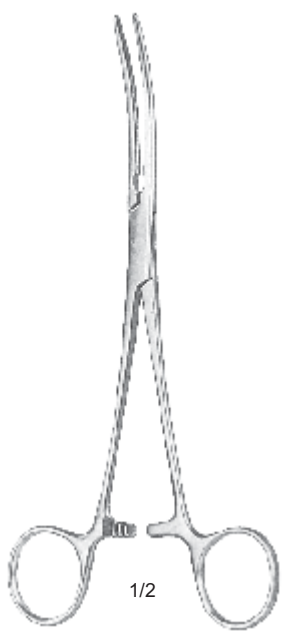

DE BAKEY PEAN

DE - BAKEY PEAN
S44-18191
 120mm (4.3/4")



1/1
S44-18192
 140mm (5.1/2")

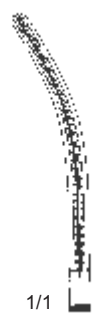

1/1
S44-18193
 160mm (6.1/4")



1/1
S44-18194
 180mm (7")



1/1
S44-18195
 200mm (8")

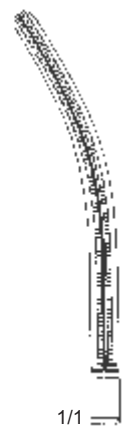

**ATRAUMA CARDIOVASCULAR
 FORCEPS**

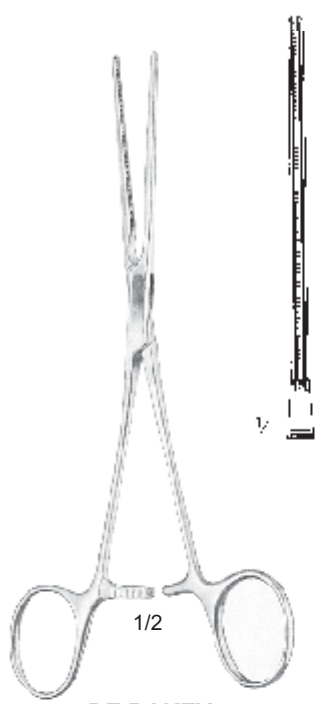

DE BAKEY
S45-18196
 170mm (6.1/4")

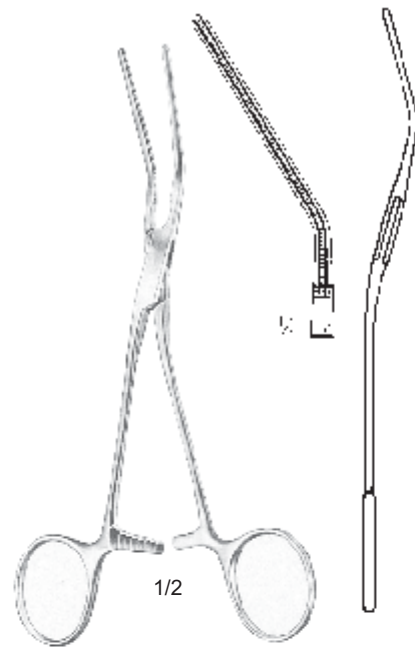

DE BAKEY
S45-18197
 160mm (6")

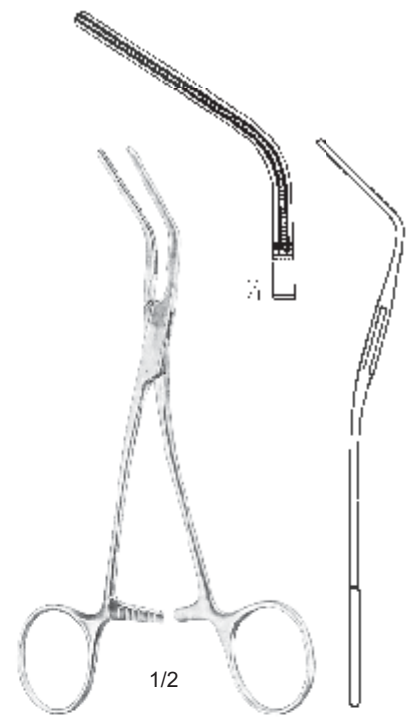

DE BAKEY
S45-18198
 150mm (6")

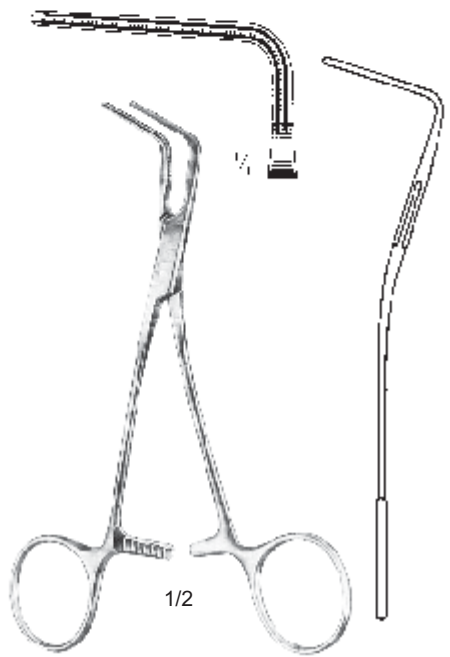

DE BAKEY
S45-18199
 150mm (6")

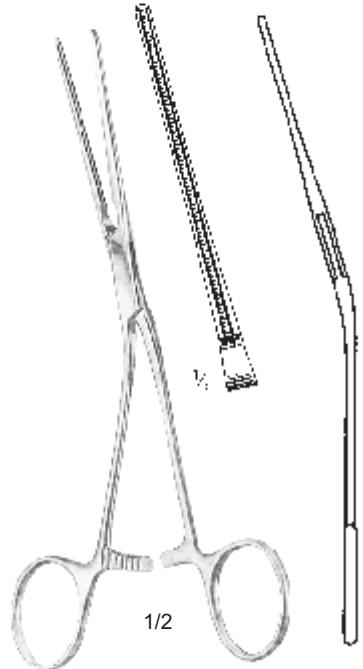

DE BAKEY
S45-18200
 170mm (6.1/4")

ATRAUMA CARDIOVASCULAR FORCEPS

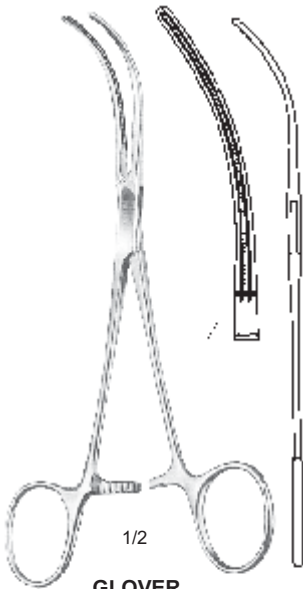

1/2
GLOVER
 S46-18201
 170mm (6.3/4")

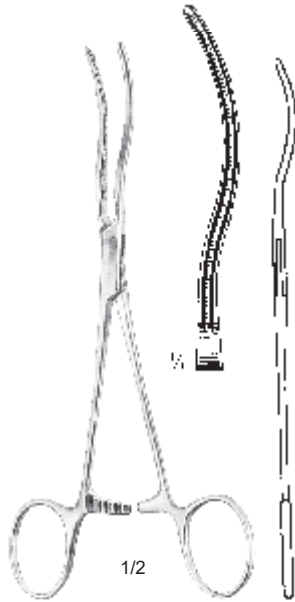

1/2
S46-18202
 170mm (6.3/4")

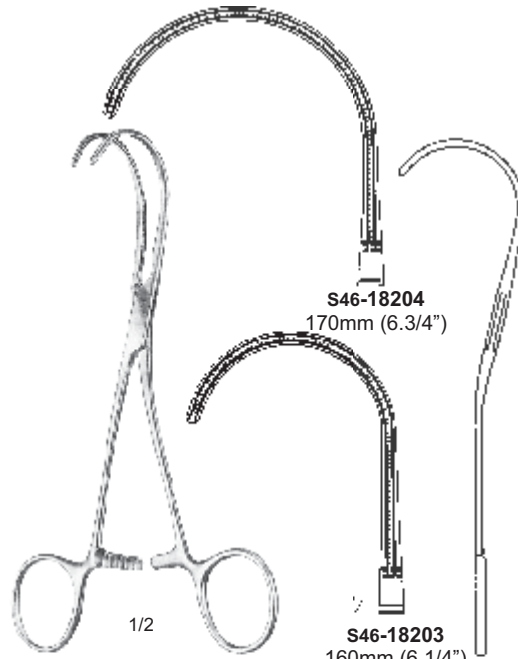

S46-18204
 170mm (6.3/4")

S46-18203
 160mm (6.1/4")

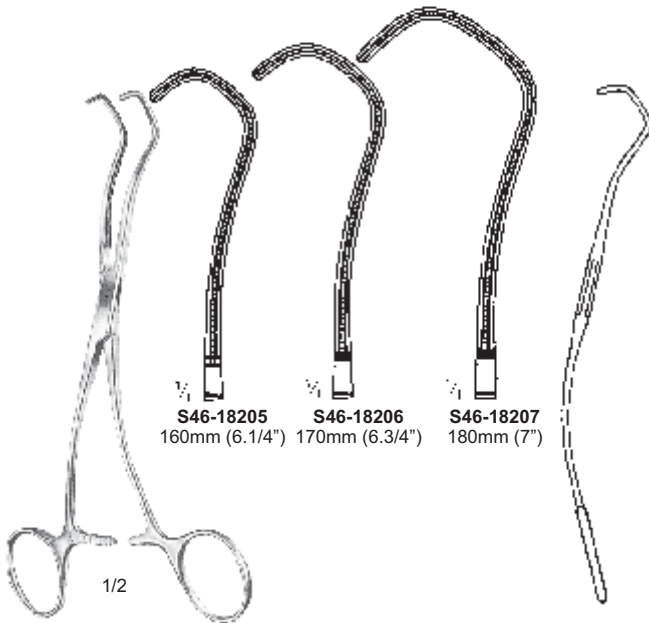

1/2
DERRA

S46-18205
 160mm (6.1/4")

S46-18206
 170mm (6.3/4")

S46-18207
 180mm (7")

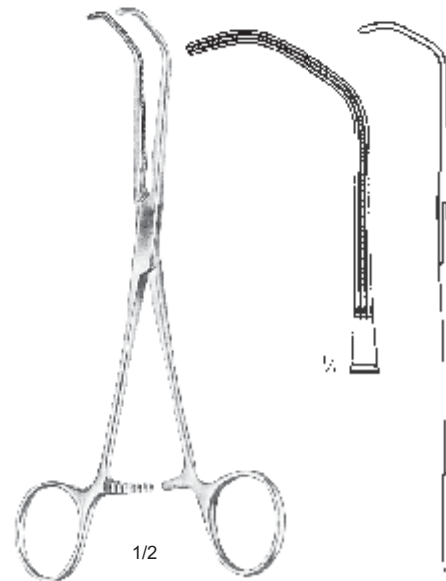

1/2
BECK
 S46-18208
 170mm (6.3/4")

■ ■ ■ ■ ■
**ATRAUMA CARDIOVASCULAR
 FORCEPS**

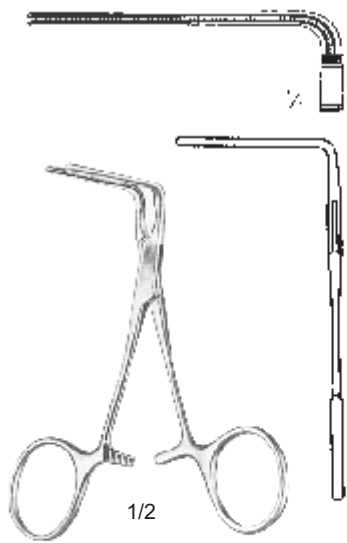

DE BAKEY
S47-18209
 100mm (4")

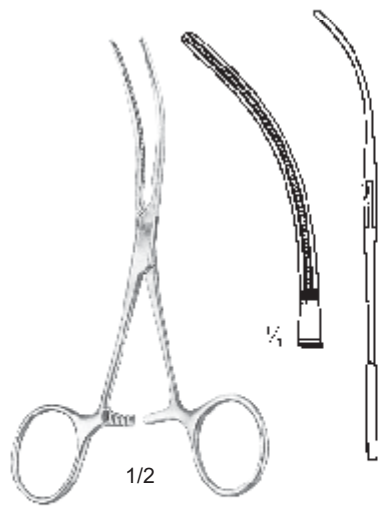

DE BAKEY
S47-18210
 110mm (4.1/4")

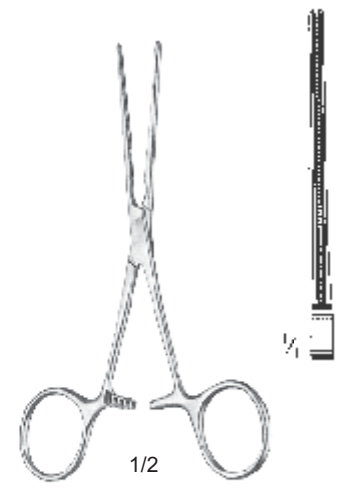

DE BAKEY
S47-18211
 120mm (4.3/4")

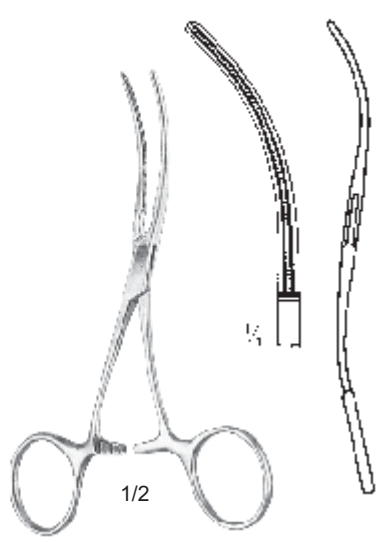

DE BAKEY
S47-18212
 120mm (4.3/4")

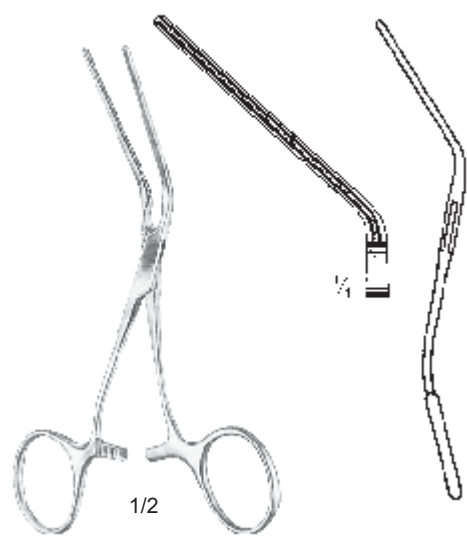

DE BAKEY
S47-18213
 130mm (5.1/4")

**ATRAUMA CARDIOVASCULAR
 FORCEPS**



S48-18214
 140mm (5.1/2")

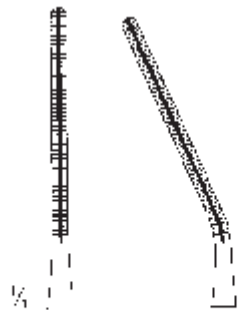

S48-18215
 140mm (5.1/2")

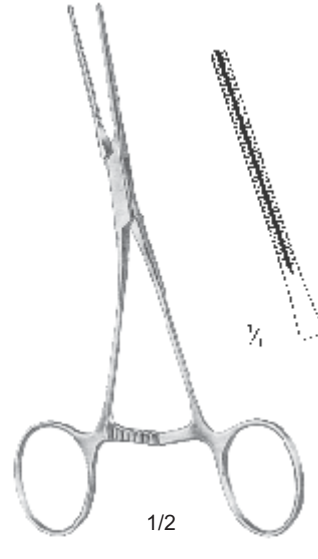

COOLEY
 Very delicate pattern
S48-18216
 140mm (5.1/2")

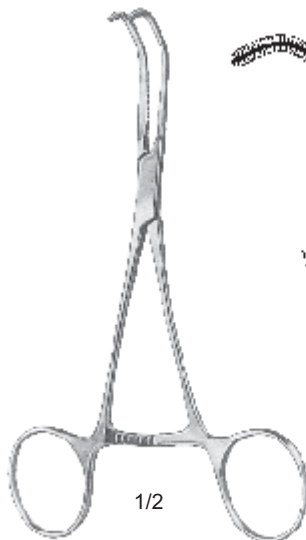

COOLEY
 Very delicate pattern
S48-18217
 140mm (5.1/2")

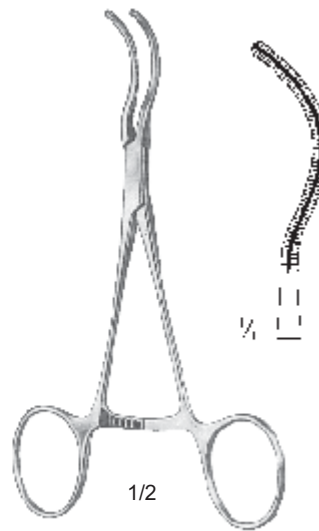
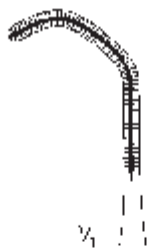

COOLEY
 Very delicate pattern
S48-18218
 140mm (5.1/2")



**ATRAUMA CARDIOVASCULAR
 FORCEPS**

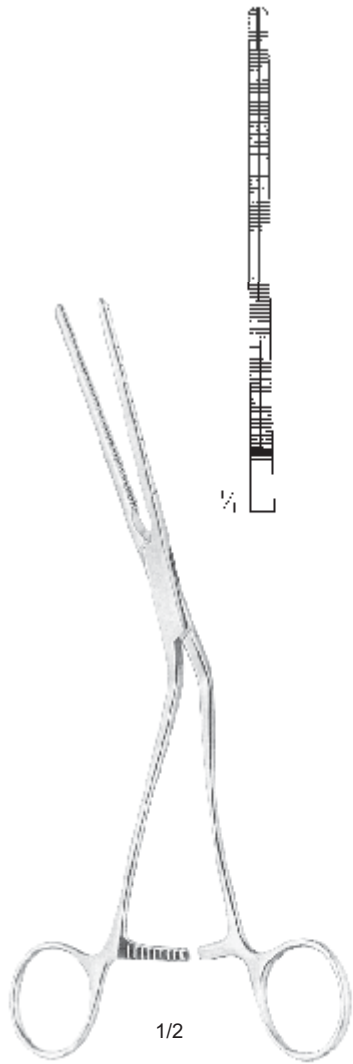

1/2
COOLEY
S49-18219
 210mm (8.1/4")



1/2
COOLEY
S49-18220
 170mm (6.3/4")

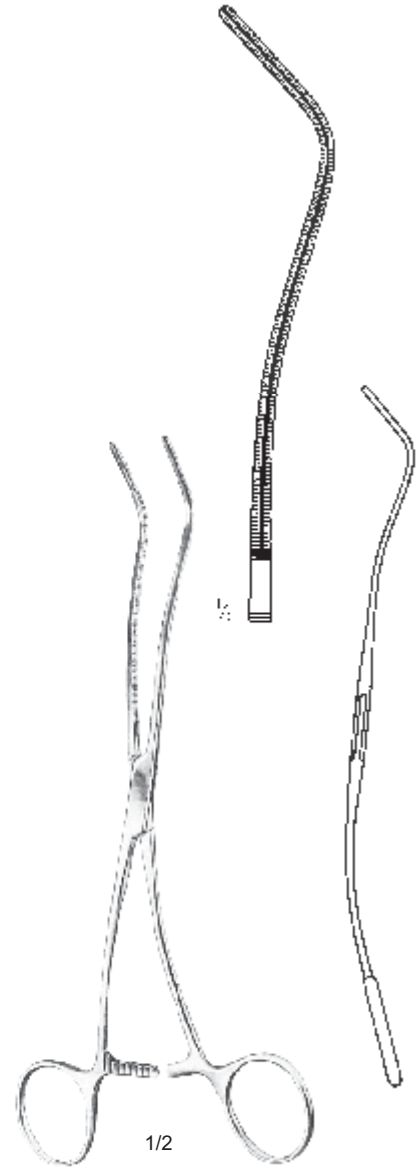

1/2
COOLEY
S49-18221
 200mm (8")

**ATRAUMA CARDIOVASCULAR
 FORCEPS**

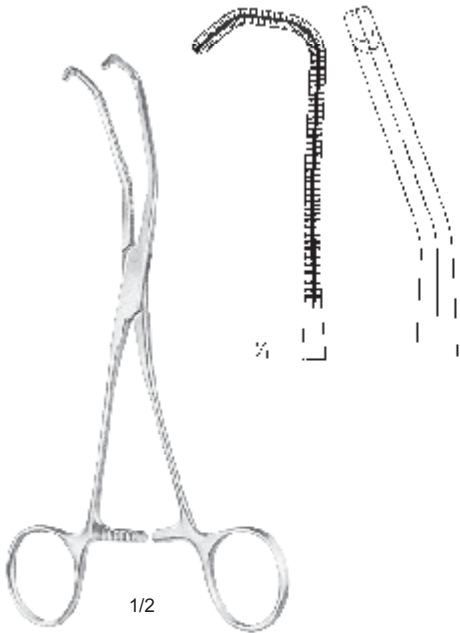

**COOLEY
 S50-18222**
 170mm (6.3/4")

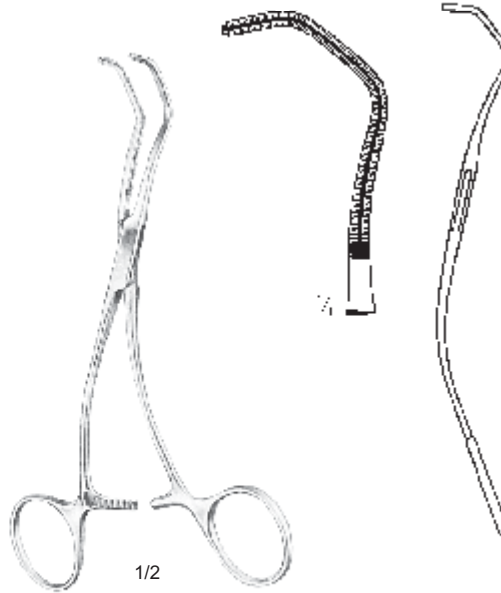

**COOLEY
 S50-18223**
 160mm (6.1/4")

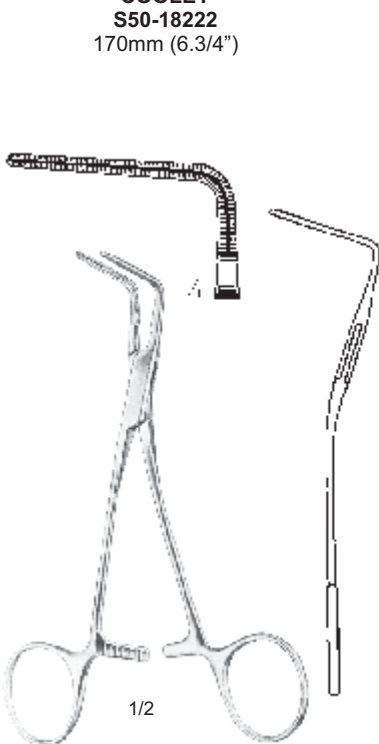

**COOLEY
 S50-18224**
 150mm (6")

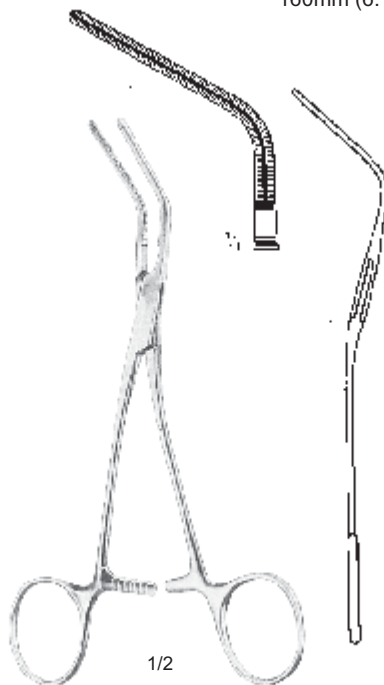

**COOLEY
 S50-18225**
 155mm (6.1/4")

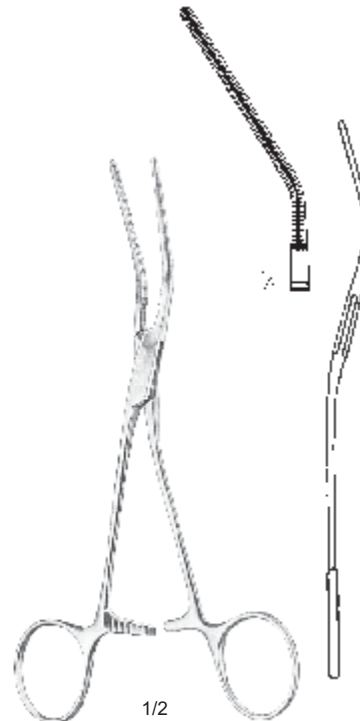

**COOLEY
 S50-18226**
 170mm (6.3/4")

**ATRAUMA CARDIOVASCULAR
 FORCEPS**

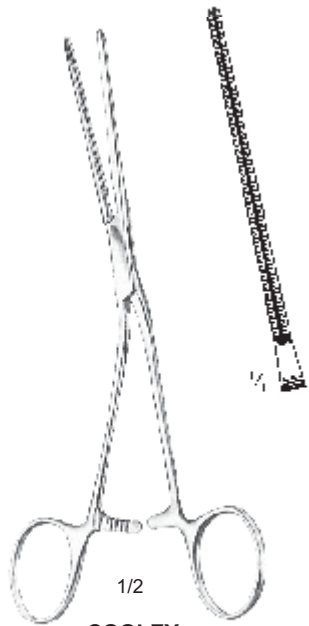

1/2
COOLEY
S51-18227
 170mm (6.3/4")

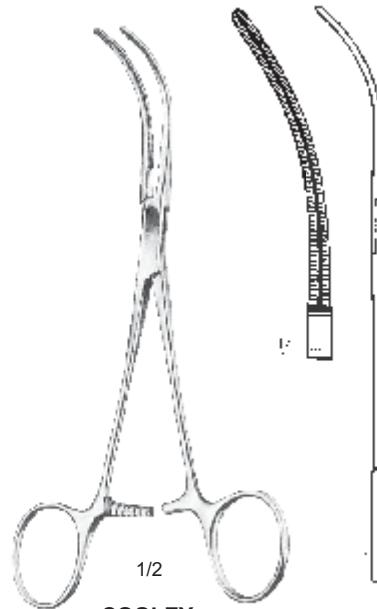

1/2
COOLEY
S51-18228
 170mm (6.3/4")

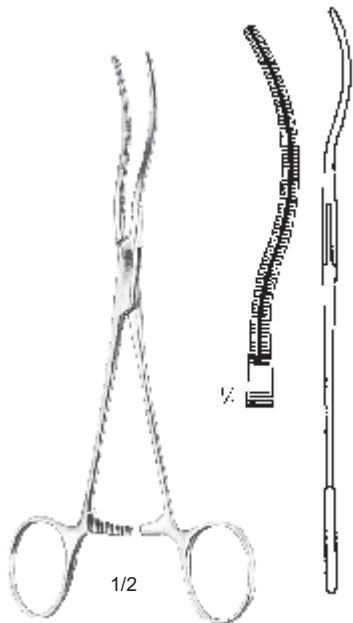

1/2
COOLEY
S51-18229
 170mm (6.3/4")



1/2
COOLEY

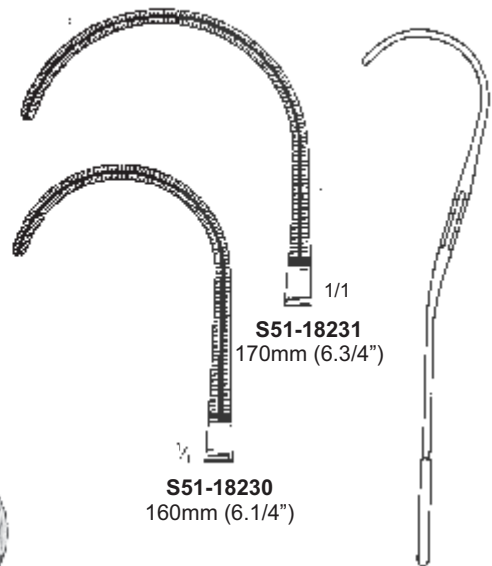

1/1
S51-18231
 170mm (6.3/4")
 1/1
S51-18230
 160mm (6.1/4")

DILATORS

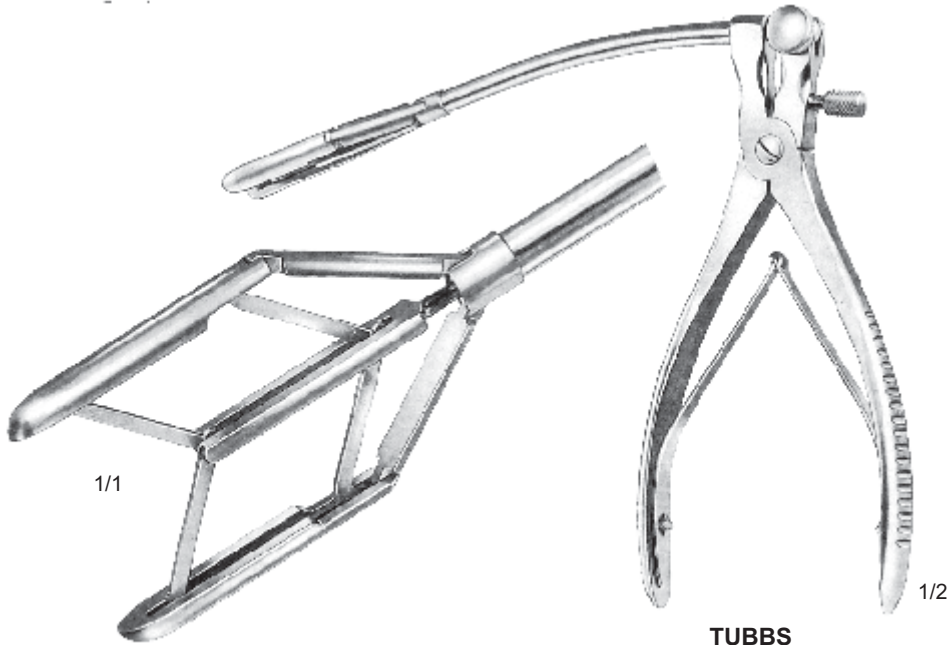

TUBBS
S52-18232
Blade opening from 8 to 42mm

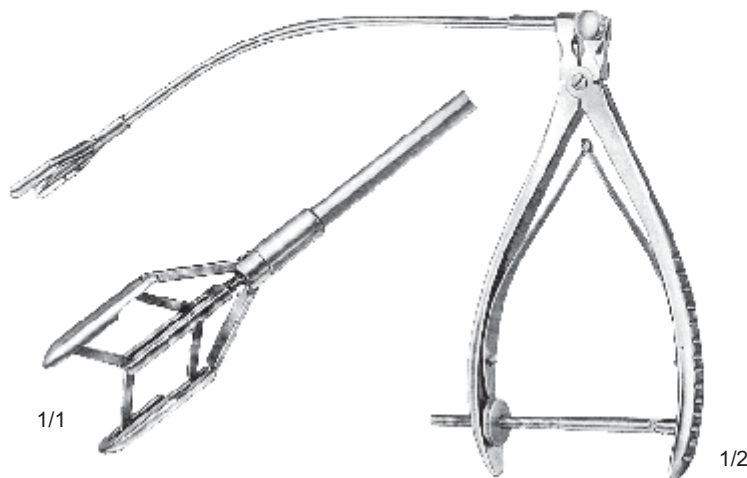

COOLEY
S52-18233
Blade opening from 8 to 15mm

VASCULAR DILATORS



- | | | | | | | | |
|-----------------------------|------------------------------|------------------------------|------------------------------|------------------------------|------------------------------|------------------------------|------------------------------|
| | | | | | | | |
| S53-18234
0.5mm Ø | S53-18235
1.0 mm Ø | S53-18236
1.5 mm Ø | S53-18237
2.0 mm Ø | S53-18238
2.5 mm Ø | S53-18239
3.0 mm Ø | S53-18240
4.0 mm Ø | S53-18241
5.0 mm Ø |



- | | | | | | |
|------------------------------|------------------------------|------------------------------|------------------------------|------------------------------|------------------------------|
| | | | | | |
| S53-18242
0.5mm Ø | S53-18243
1.0 mm Ø | S53-18244
1.5 mm Ø | S53-18245
2.0 mm Ø | S53-18246
2.5 mm Ø | S53-18247
3.0 mm Ø |
| | | | | | |
| S53-18248
3.5 mm Ø | S53-18249
4.0 mm Ø | S53-18250
4.5 mm Ø | S53-18251
5.0 mm Ø | S53-18252
7.0 mm Ø | S53-18253
9.0 mm Ø |

INSTRUMENTS

TUNNELING INSTRUMENT

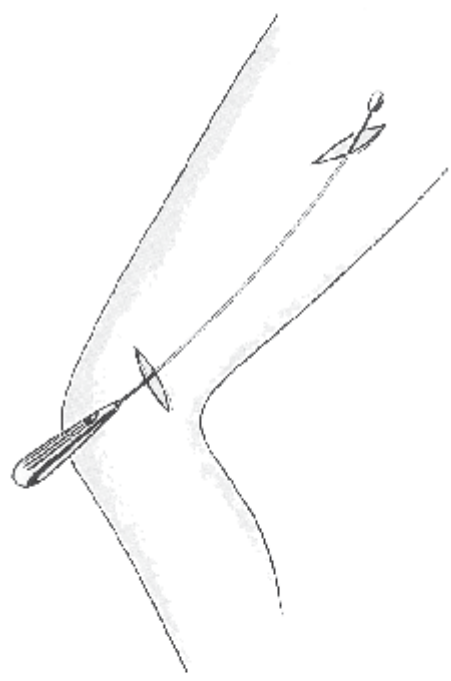
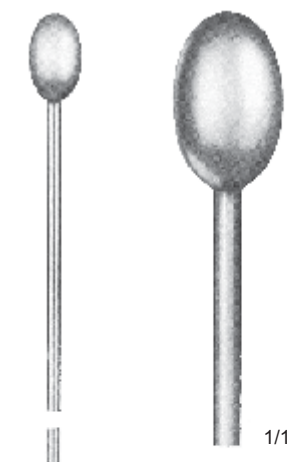

DE BAKEY
S54-18254
500mm (20")

TUNNELING SET



S55-18255
 Complete Set



S55-18256
 6 mm

S55-18257
 8mm

S55-18258
 10mm

S55-18259
 12mm



S55-18260

S55-18261

110mm x 37mm
 80 mm x 32mm
 80 mm x 24mm

- S55-18255** Tunneling set complete
- S55-18262** Universal Handle (2x)
- S55-18263** Tunneling shaft, curved, 225mm
- S55-18264** Tunneling shaft, straight, 225mm
- S55-18265** Tunneling shaft, curved, 540mm
- S55-18256** Bullet tip 6mm (2 x)
- S55-18257** Bullet tip 8mm (2 x)
- S55-18258** Bullet tip 10mm (2 x)
- S55-18259** Bullet tip 12mm (2 x)
- S55-18260** Vein tip
- S55-18261** Luer Adaptor
- Plate for tips only
- Sterilizing cases 550 x 115 x 35mm

S55-18262

S55-18263
 225mm

S55-18264
 225mm

S55-18265
 540mm



ENDARTERECTOMY

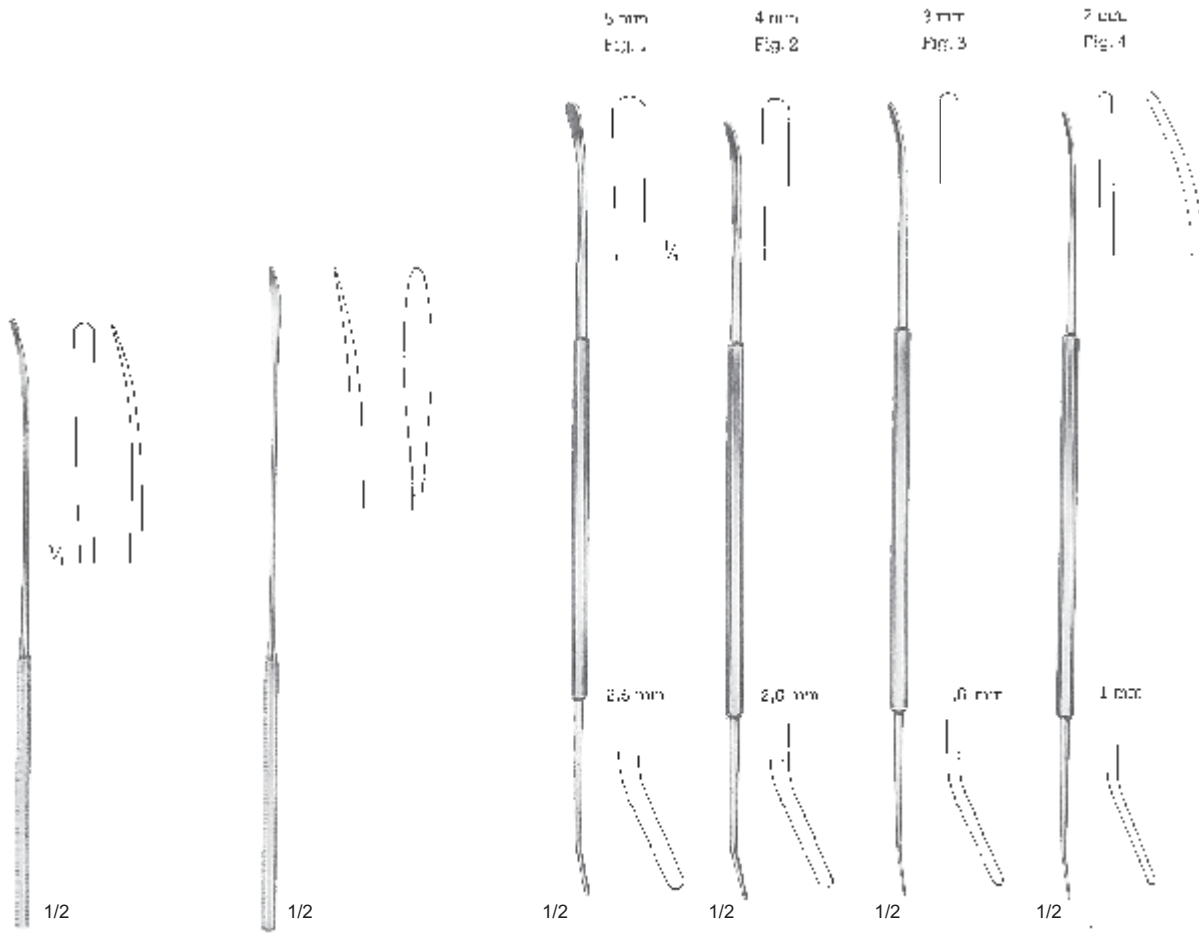

S56-18266
185mm (7")
Blunt

S56-18267
140mm (5.1/2")
Blunt

ROBB
S56-18268
240mm (10")

ROBB
S56-18269
240mm (10")

ROBB
S56-18270
240mm (10")

ROBB
S56-18271
240mm (10")



NERVE HOOKS, TOURNIQUETS



CRILE
S57-18272
 200mm (8")



RUMEL-BELMONT
S57-18273
 330mm (13")

NEONATAL & PEDIATRIC CLAMPS



Very delicate pattern

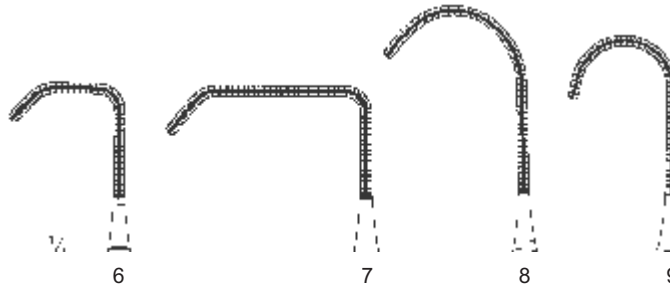
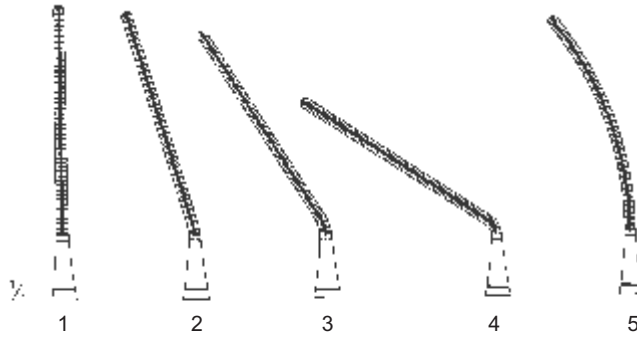
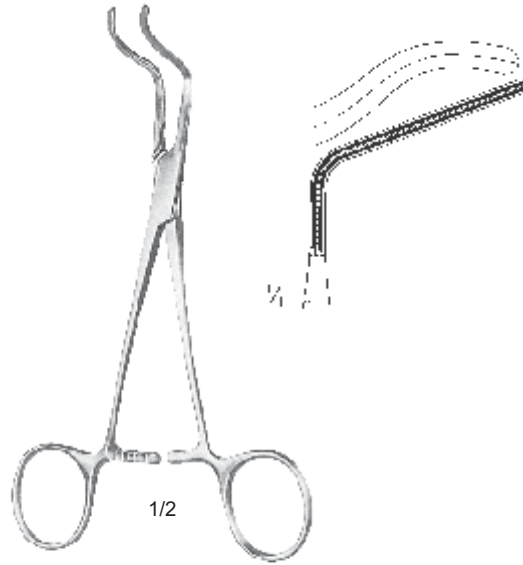

Fig.	Straight
1	S58-18274 145mm (5.3/4")
2	S58-18275 145mm (5.3/4")
3	S58-18276 145mm (5.3/4")
4	S58-18277 135mm (5.1/4")
5	S58-18278 140mm (5.1/2")
6	S58-18279 135mm (5.1/4")
7	S58-18280 135mm (5.1/4")
8	S58-18281 140mm (5.3/4")
9	S58-18282 135mm (5.1/4")

Fig.	Angled
1	S58-18283 145mm (5.3/4")
2	S58-18284 145mm (5.3/4")
3	S58-18285 145mm (5.3/4")
4	S58-18286 135mm (5.1/4")
5	S58-18287 140mm (5.1/2")
6	S58-18288 135mm (5.1/4")
7	S58-18289 135mm (5.1/4")
8	S58-18290 140mm (5.3/4")
9	S58-18291 135mm (5.1/4")

Fig.	Curved
1	S58-18292 145mm (5.3/4")
2	S58-18293 145mm (5.3/4")
3	S58-18294 145mm (5.3/4")
4	S58-18295 135mm (5.1/4")
5	S58-18296 140mm (5.1/2")
6	S58-18297 135mm (5.1/4")
7	S58-18298 135mm (5.1/4")
8	S58-18299 140mm (5.3/4")
9	S58-18300 135mm (5.1/4")

ATRAUMA PEDIATRIC CLAMPS



SUBRAMANIAN - MINIATURE
S59-18301
 155mm (6")

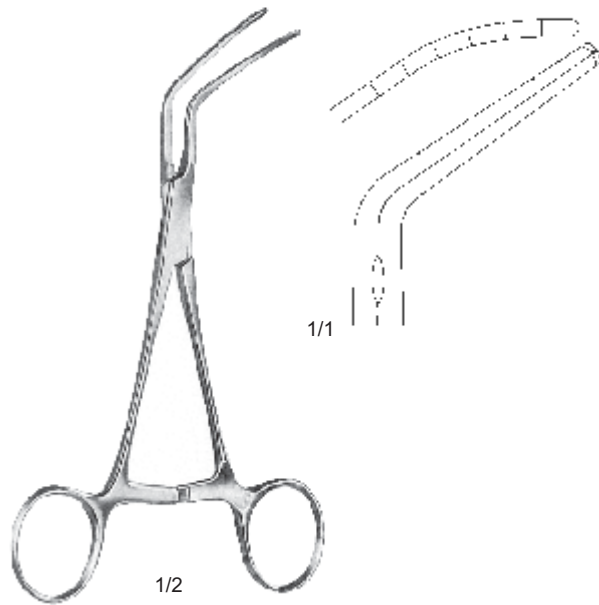

SUBRAMANIAN
S59-18302
 160mm (6.1/4")

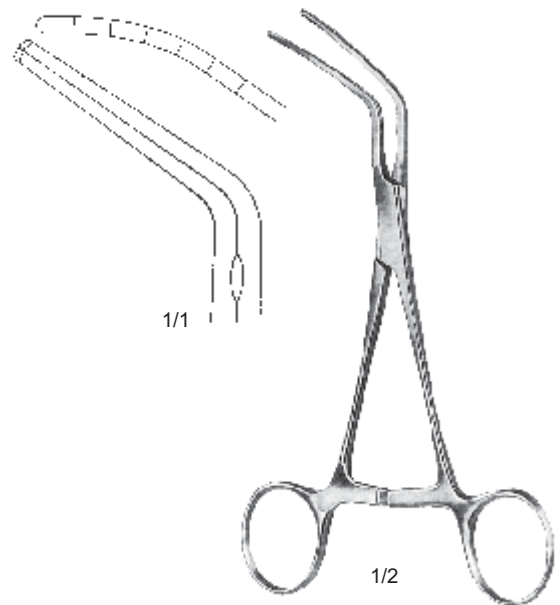

SUBRAMANIAN
S59-18303
 160mm (6.1/4")

**ATRAUMA PEDIATRIC CLAMPS
 VERY DELICATE PATTERNS**

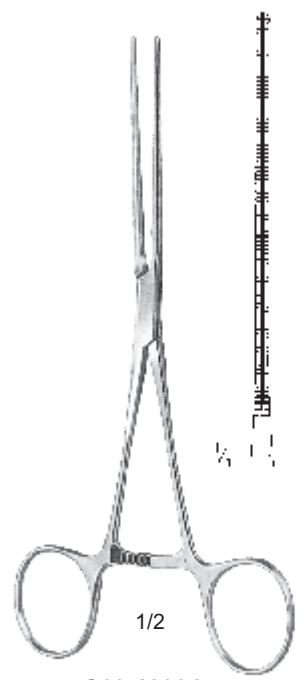

S60-18304
 165mm (6.1/2")

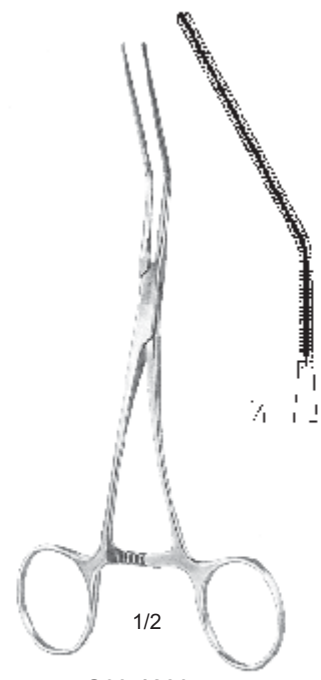

S60-18305
 160mm (6.1/4")

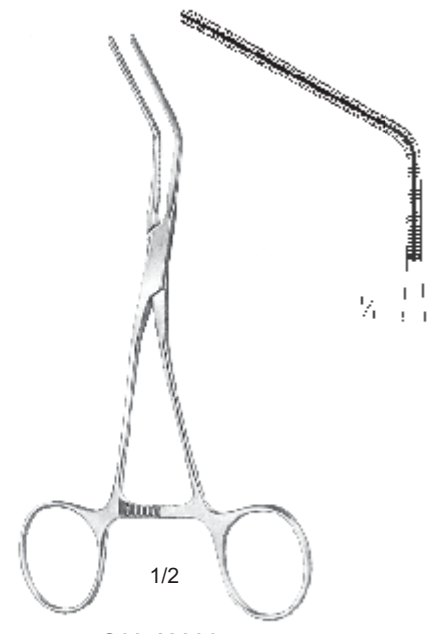

S60-18306
 150mm (6")

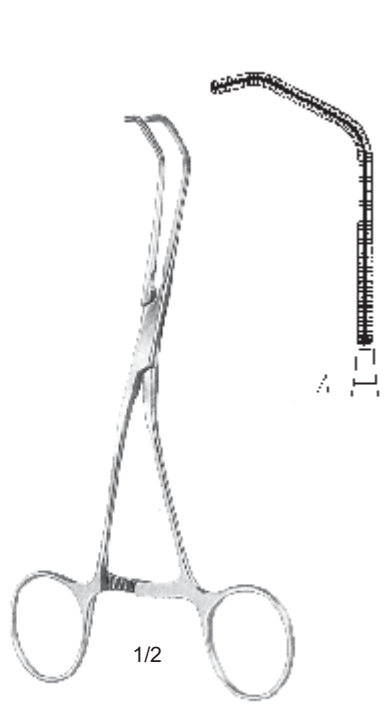

S60-18307
 150mm (6")

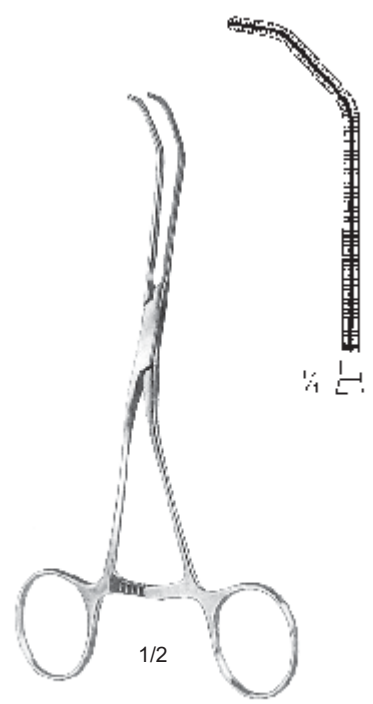

S60-18308
 150mm (6")

NEONATAL CLAMPS VERY DELICATE PATTERNS



S61-18309
 130mm (5")



S61-18310
 130mm (5")

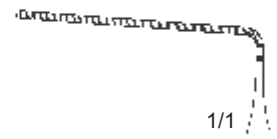

S61-18311
 110mm (4.1/2")



S61-18312
 120mm (4.3/4")

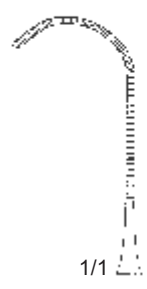

S61-18313
 120mm (4.3/4")



S61-18314
 120mm (4.3/4")



S61-18315
 120mm (4.3/4")



CASTANEDA

1/2



LIGATURE CARRIERS

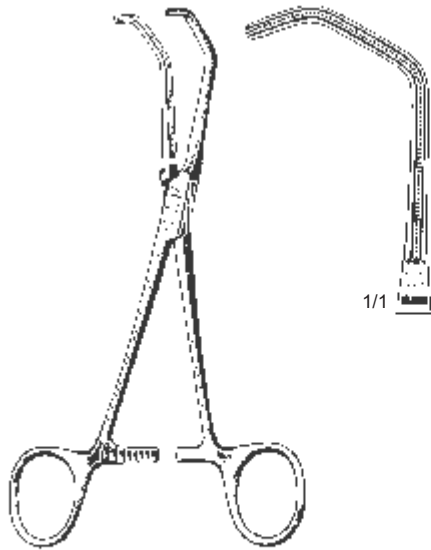

1/1

DE BAKEY-BECK

S62-18316
 165mm (6.1/2")

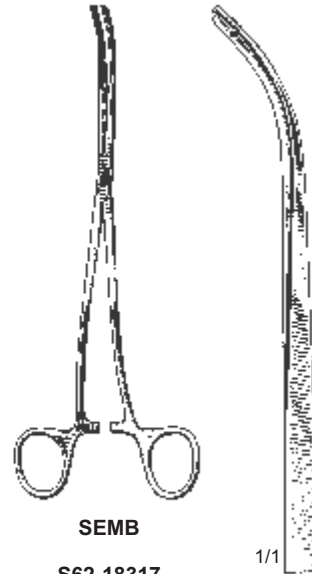

1/1

SEMB

S62-18317
 250mm (10")

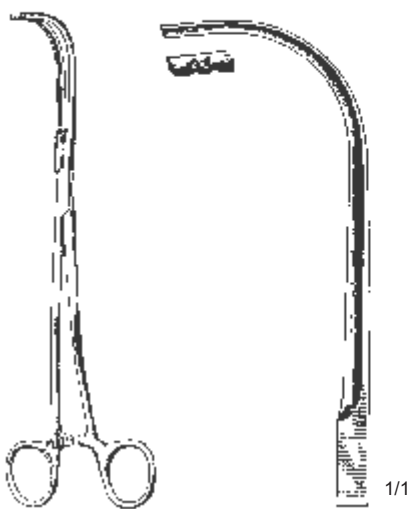

1/1

SEMB

S62-18318
 230mm (9")

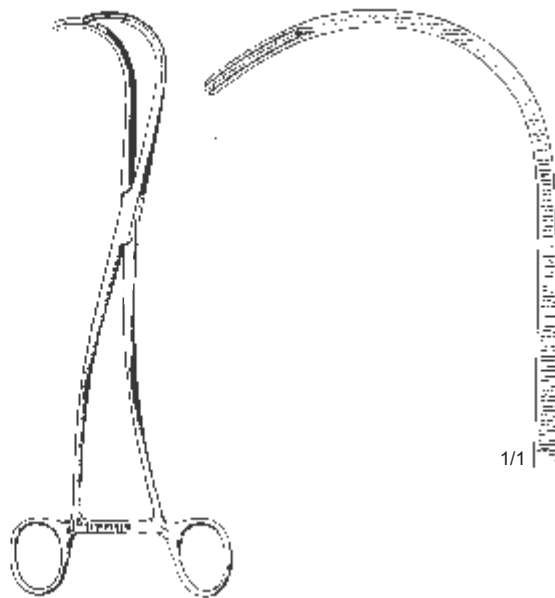

1/1

DE BAKEY

S62-18319
 250mm (10")



CAVAL OCCLUSION CLAMPS

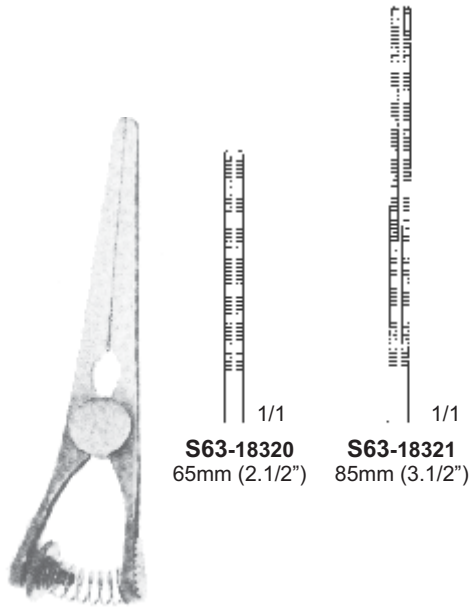

S63-18320
65mm (2.1/2")

S63-18321
85mm (3.1/2")

MINI COOLEY-GLOVER

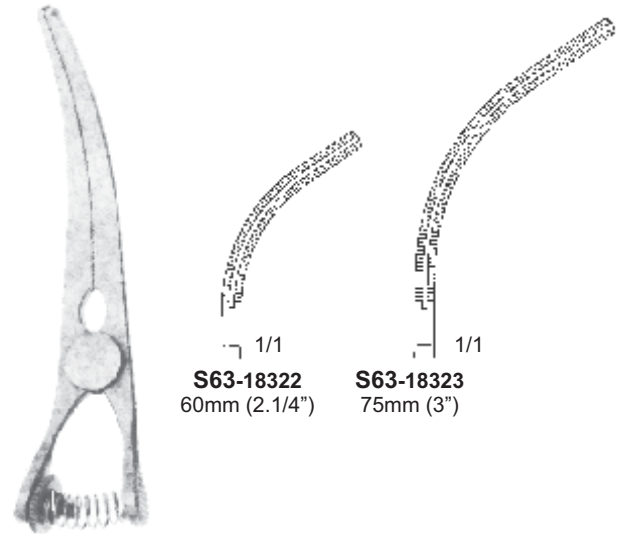

S63-18322
60mm (2.1/4")

S63-18323
75mm (3")

MINI COOLEY-GLOVER

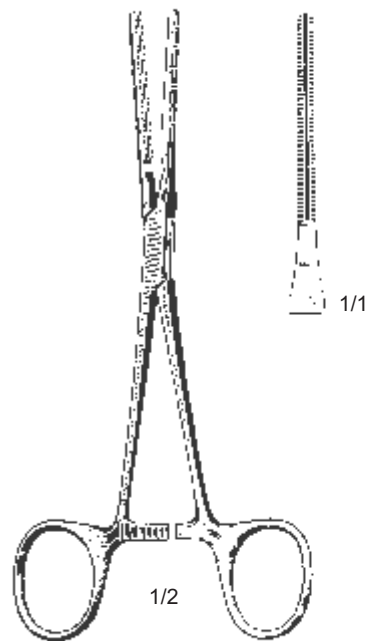

COOLEY
Patent Ducts Clamps

S63-18324
160mm (6.1/4")

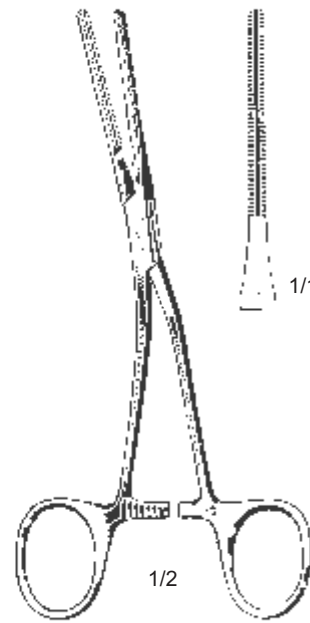

COOLEY
Patent Ducts Clamps

S63-18325
160mm (6.1/4")

BULLDOG CLAMPS

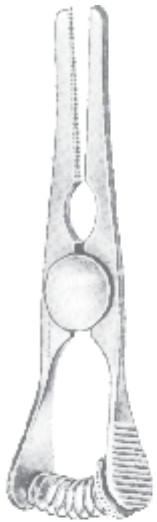

1/1

COOLEY



1/1

S64-18326
70mm (2.3/8")



1/1

S64-18327
80mm (3.1/4")



1/1

S64-18328
95mm (3.3/4")



1/1

S64-18329
115mm (4.1/2")

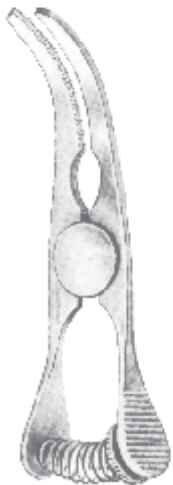

1/1

COOLEY



1/1

S64-18330
65mm (2.12")



1/1

S64-18331
75mm (3")



1/1

S64-18332
85mm (3.1/4")



1/1

S64-18333
105mm (4.1/4")

BULLDOG CLAMPS



COOLEY



1/1
S65-18334
 80mm (3.1/4")



1/1
S65-18335
 90mm (3.1/2")



1/1
S65-18336
 105mm (4.1/4")

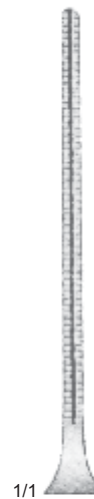

1/1
S65-18337
 125mm (5")



COOLEY



1/1
S65-18338
 80mm (3.1/4")



1/1
S65-18339
 85mm (3.1/2")

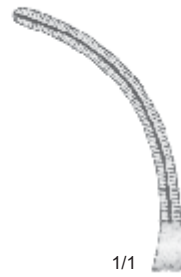

1/1
S65-18340
 95mm (3.3/4")



1/1
S65-18341
 120mm (4.1/4")

BULLDOG CLAMPS



S66-18342
 90mm(3.1/2")
S66-18343
 110mm (4.1/4")



S66-18344
 90mm(3.1/2")
S66-18345
 110mm (4.1/4")



S66-18346
 bent to left
 110mm (4.1/4")



S66-18347
 bent to right
 110mm (4.1/4")

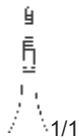

S66-18348
 8mm

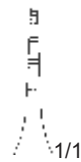

S66-18349
 12mm



S66-18350
 16mm



S66-18351
 8mm



S66-18352
 12mm



S66-18353
 8mm



S66-18354
 12mm

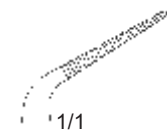

S66-18355
 16mm

**MICRO
 BULLDOG CLAMPS**

BULLDOG CLAMPS

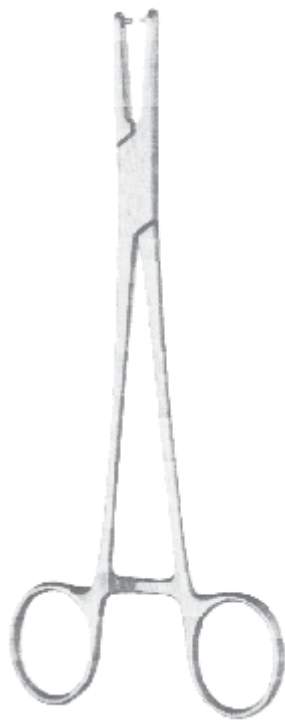

APPLYING FORCEPS

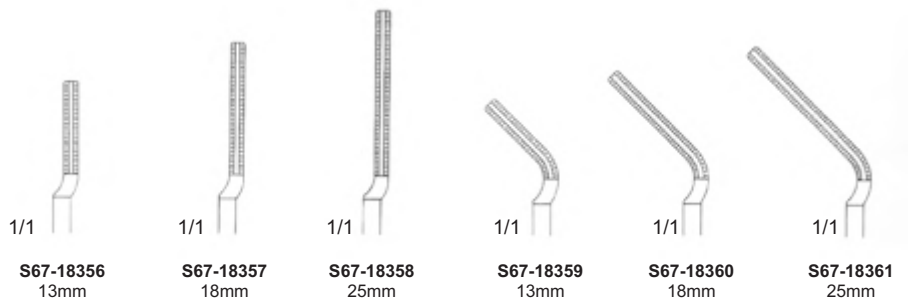

BULLDOG CLAMP



JOHNS HOPKINS

- S67-18362 38mm
- S67-18363 51mm
- S67-18364 57mm
- S67-18365 63mm
- S67-18366 70mm
- S67-18367 75mm
- S67-18368 90mm

BULLDOG CLAMPS



PERIPHERAL
S68-18369
 180mm (7")



2.4mm

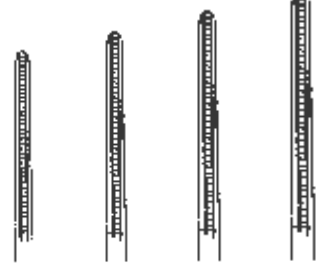

DE BAKEY

- S68-18370** 160mm (6.1/4")
- S68-18371** 200mm (8")
- S68-18372** 240mm (9.1/4")
- S68-18373** 300mm (12")



3.0mm



DE BAKEY

- S68-18374** 160mm (6.1/4")
- S68-18375** 200mm (8")
- S68-18376** 240mm (9.1/4")
- S68-18377** 300mm (12")

STERILIZATION TRAYS



EDINBURGH TRAYS

T1-19000	Edinburgh Tray Open Corner with Lips	12"x10"
T1-19001	Edinburgh Tray Open Corner with Lips	12"x12"
T1-19002	Edinburgh Tray Open Corner with Lips	12"x18"
T1-19003	Edinburgh Tray Open Corner with Lips	12"x24"
T1-19004	Edinburgh Tray Open Corner with Lips	18"x18"
T1-19005	Edinburgh Tray Open Corner with Lips	18"x24"
T1-19006	Edinburgh Tray Open Corner with Lips	24"x24"

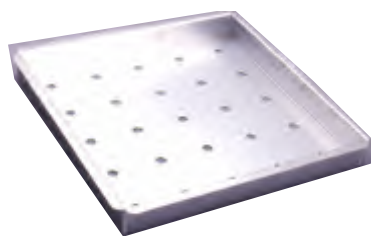

PERFORATED

T1-19007	Edinburgh Tray Closed Corner with Lips	12"x10"
T1-19008	Edinburgh Tray Closed Corner with Lips	12"x12"
T1-19009	Edinburgh Tray Closed Corner with Lips	12"x18"
T1-19010	Edinburgh Tray Closed Corner with Lips	12"x24"
T1-19011	Edinburgh Tray Closed Corner with Lips	18"x18"
T1-19012	Edinburgh Tray Closed Corner with Lips	18"x24"
T1-19013	Edinburgh Tray Closed Corner with Lips	24"x24"

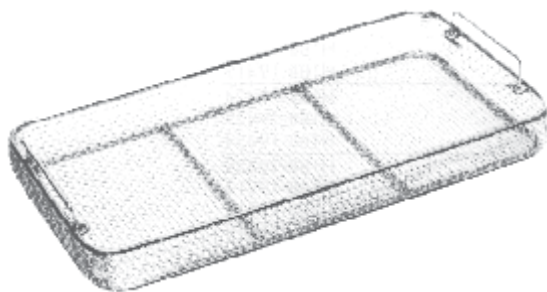

STERILIZATION TRAY

Wire Mesh

T1-19014
 240 x 250 x 5 mm

T1-19015
 480 x 250 x 5mm

T1-19016
 550 x 250 x 5mm

Wire mesh Tray and basket can be made in any size on request



STERILIZATION TRAY

Perforated Steel Mesh

T1-19017
 26 x 26 x 5mm

T1-19018
 480 x 250 x 5mm

HOLLOW WEARS



JUG GRADUATED
Stainless Steel

- T2-19019 250 ml
- T2-19020 500 ml
- T2-19021 1000 ml

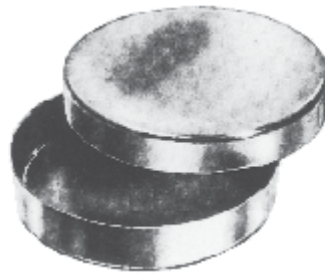

T2-19022
100 x 20 mm

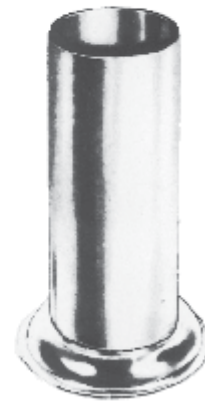

- T2-19023 30 x 90mm
- T2-19024 50 x 100mm
- T2-19025 50 x 130mm
- T2-19026 50 x 175mm
- T2-19027 75 x 100mm
- T2-19028 75 x 130mm
- T2-19029 75 x 175mm
- T2-19030 100 x 175mm
- T2-19031 100 x 200mm



LOTION BOWEL

- T2-19032 165 x 60 0.75
- T2-19033 175 x 70 1.00
- T2-19034 220 x 80 2.00
- T2-19035 225 x 90 2.50
- T2-19036 240 x 110 3.00
- T2-19037 255 x 115 4.00
- T2-19038 275 x 115 4.50
- T2-19039 290 x 125 6.00
- T2-19040 310 x 120 6.00
- T2-19041 345 x 125 8.50
- T2-19042 380 x 130 11.00
- T2-19043 415 x 140 14.00



KIDNEY DISH

- T2-19044 125mm (5")
- T2-19045 150mm (6")
- T2-19046 180mm (7")
- T2-19047 250mm (10")
- T2-19048 300mm (12")



BUCKET

- T2-19049 Bucket Stainless Steel 10 Liter
- T2-19050 Bucket Stainless Steel 12 Liter
- T2-19051 Bucket Stainless Steel 15 Liter

BIPOLAR FORCEPS

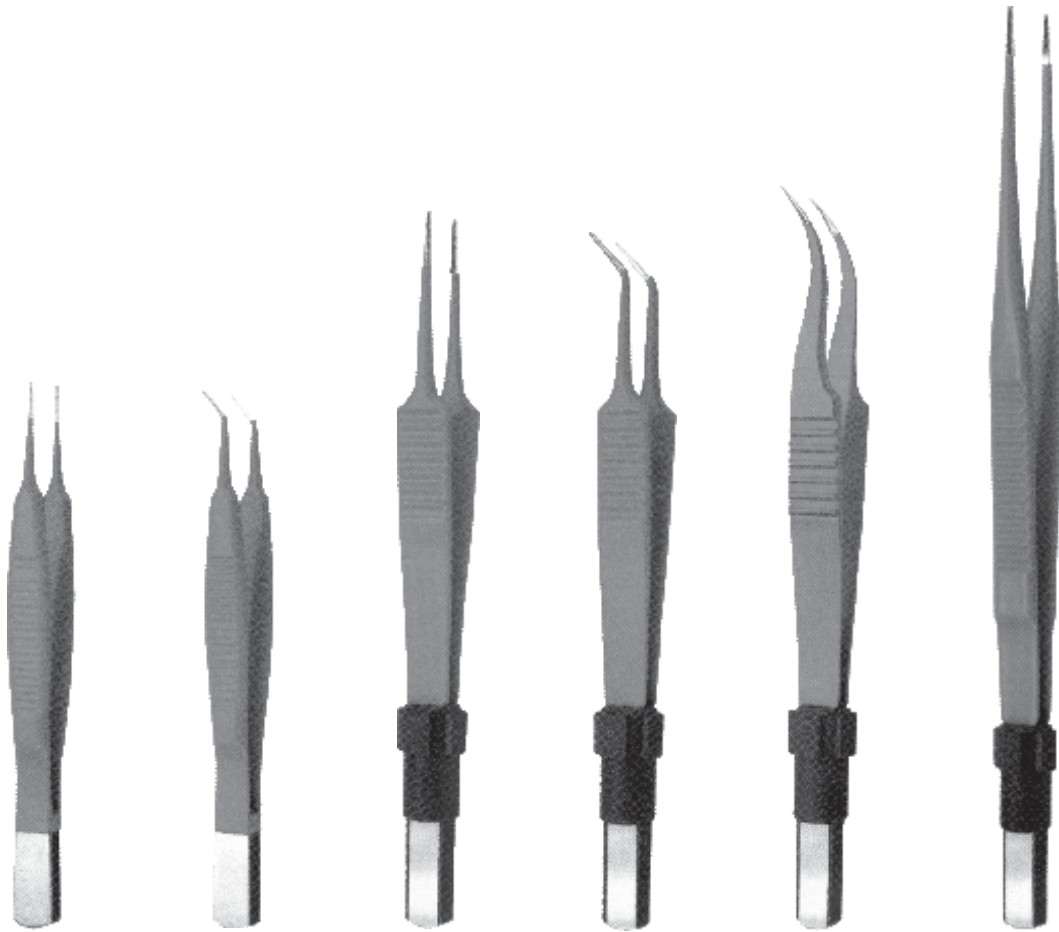

McPHERSON
U1-20100
 70mm
 (2.3/4")
 Straight

McPHERSON
U1-20101
 70mm
 (2.3/4")
 Angled

JEWELER
FORCEPS
U1-20102
 110 mm
 (4.1/4")
 Straight

JEWELER
FORCEPS
U1-20103
 110 mm
 (4.1/4")
 Angled

JEWELER
FORCEPS
U1-20104
 110 mm
 (4.1/4")
 Curved

BIPOLAR FORCEPS
 Straight
U1-20105 150mm (6")
U1-20106 180mm (7")
U1-20107 200mm (8")
U1-20108 220mm (8.1/2")
U1-20109 240mm (9.1/2")

BIPOLAR FORCEPS



**BIPOLAR FORCEPS
 BAYONETT**
 U2-20110 180mm (7")
 U2-20111 200mm (8")
 U2-20112 220mm (8.1/2")
 U2-20113 240mm (9.1/2")

**BIPOLAR FORCEPS
 Angled downward**
 U2-20114 150mm (6")
 U2-20115 180mm (7")
 U2-20116 200mm (8")
 U2-20117 220mm (8.1/2")
 U2-20118 240mm (9.1/2")

**BIPOLAR FORCEPS
 BAYONETT
 Angled Upward**
 U2-20119 180mm (7")
 U2-20120 200mm (8")
 U2-20121 220mm (8.1/2")
 U2-20122 240mm (9.1/2")

**BIPOLAR FORCEPS
 BAYONETT
 Angled Downward**
 U2-20123 180mm (7")
 U2-20124 200mm (8")
 U2-20125 220mm (8.1/2")
 U2-20126 240mm (9.1/2")

MONOPOLAR CABLES



MONOPOLAR CABLES

U3-20127 3 meter cable, Hook connector, cable with active instrument connector

U3-20128 5 meter cable, Hook connector, cable with active instrument connector

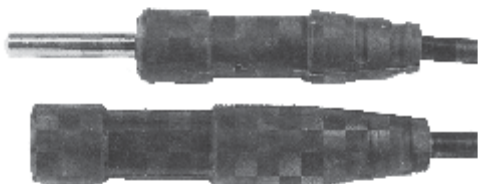

U3-20129 3 meter cable, 4mm plug, cable with active instrument connector

U3-20130 5 meter cable, 4mm plug, cable with active instrument connector

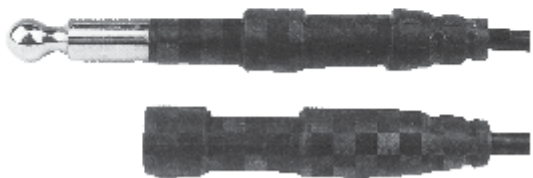

U3-20131 3 meter cable, 8mm jack plug (Bovie) cable with active instrument connector

U3-20132 5 meter cable, 8mm jack plug (Bovie) cable with active instrument connector



BI-POLAR CABLES



U4-20133
 Bi-polar cable 4mm coaxible machine end



U4-20134
 Bi-polar cable wolf machine end

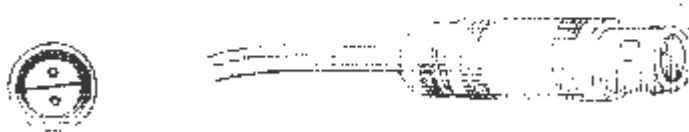

U4-20135
 Bi-polar cable Eschman (Lemo) machine end

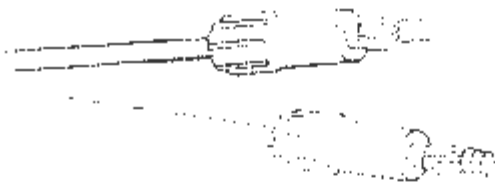

U4-20136
 Bi-polar cable twin 4mm machine end



U4-20137
 Bi-polar cable Aesculap machine end



U4-20138
 Bi-polar cable Valley lab machine end



BI-POLAR CABLES

U5-20139
 Bi-polar cable European instrument end

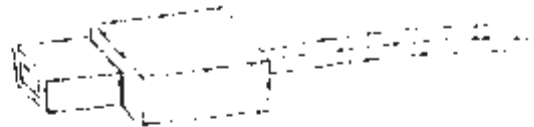

U5-20140
 Bi-polar cable Wolf instrument end

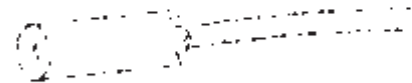

U5-20141
 Bi-polar cable USA instrument end



U5-20142
 Bi-polar cable Thackray blade instrument end



U5-20143
 Bi-polar cable Thackray pin instrument end

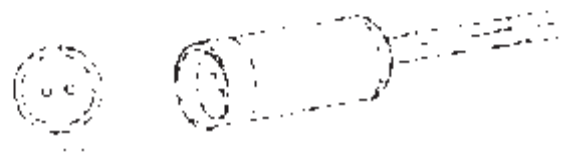

MONOPOLAR FORCEPS



DISSECTING FORCEPS
U6-20144
 150mm (6")
 180mm (7")



DISSECTING FORCEPS
U6-20145
 200mm (8")
 250mm (10")



MCINDOE FORCEPS
U6-20146
 150mm (6")



ADSON
U6-20147
 100mm (7.1/2")



WILSON HEY FORCEPS
U6-20148
 150mm (6")



WILSON HEY FORCEPS
U6-20149 180mm (7"), **U6-20150** 230mm (9")



RICHES FORCEPS
U6-20151
 125mm (5")
U6-20152
 150mm (6")
U6-20153
 180mm (7")
U6-20154
 200mm (8")
U6-20155
 230mm (9")

**MONOPOLAR HANDLES, BLADES,
 NEEDLE, TURNER WARWICK SCISSORS**



HANDLES
 For ball and plate electrode carriers
U7-20156
 17mm (6.1/4")



HANDLES
 For needles and loops
U7-20157
 200mm (8")



HANDLES
 For needles and loops
U7-20158
 15mm (6")



BLADES
U7-20159
 Large Diathermy blade electrode (Insulated)



BLADES
U7-20160
 Large Diathermy blade electrode (Non-Insulated)



BLADES
U7-20161
 Small Diathermy blade electrode



NEEDLE
U7-20162
 Short Sharp



NEEDLE
U7-20163
 Long Insulated



NEEDLE
U7-20164
 Long Sharp Angled



NEEDLE
U7-201654
 Long Sharp Straight



TURNER WARWICK SCISSOR
U7-20166 125mm (5")
U7-20167 145mm (5.1/4")
U7-20168 150mm (6")
U7-20169 180mm (7")
U7-20170 230mm (9")



SCALPLe HANDLE
U7-20171
 No3, No4

COLPOSOPY LOOPS



U8-20172
 8mm large loop electrode



U8-20173
 12mm large loop electrode



U8-20174
 15mm large loop electrode



U8-20175
 20mm large loop electrode

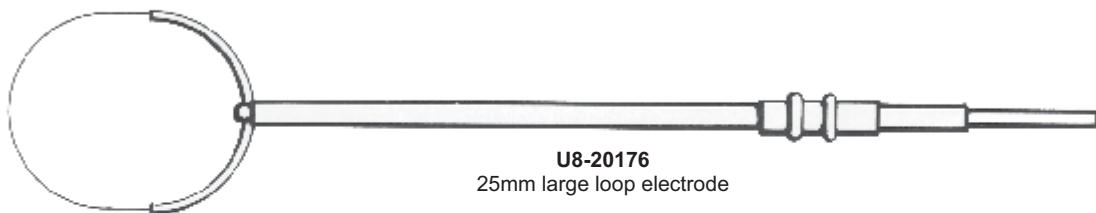

U8-20176
 25mm large loop electrode



U8-20177
 3mm extended ball electrode



U8-20178
 5mm extended ball electrode



DIATHERMY QUIVER

U9-20179
 40mm diameter with ring

U9-20180
 60mm diameter with ring



U9-20181
BALL ELECTRODE



U9-20182
NEEDLE ELECTRODE



U9-20187
EXTENDED
BLADE ELECTRODE



U9-20188
SWITCHING PENCIL
 3m cord
U9-20189
 5m cord

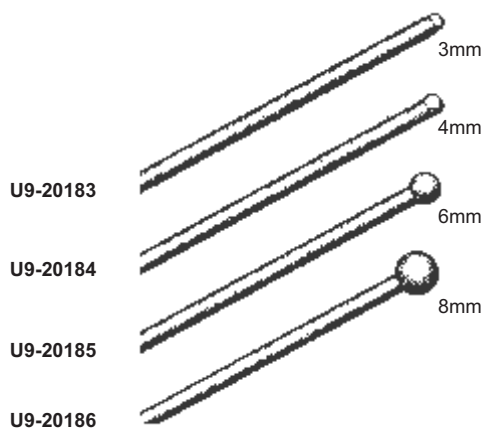

- U9-20183**
- U9-20184**
- U9-20185**
- U9-20186**

BALL ELECTRODES

INDEX

A	
AMERICAN PATTERN (SCISSORS)	14
AUFRICHT (SCISSORS)	15
ADSON (DELICATE DISSECTING FORCEPS)	42
ADSON (TOOTHED DISSECTING FORCEPS)	45
ADSON-BROWN (TOOTHED DISSECTING FORCEPS)	45
ARTHURE (SPLINTER FORCEPS)	48
ADSON ("TC" DISSECTING FORCEPS)	49
ALLIS ("TC" DISSECTING FORCEPS)	51
ADSON-BROWN ("TC" DISSECTING FORCEPS)	55
ALLIS (TISSUE FORCEPS)	88
AMERICAN PATTERN ALLIS (TISSUE FORCEPS)	88
ARRUGA (MICRO NEEDLE HOLDERS)	92
ANEL LACHRYMAL (PROBES)	138
ABDOMINAL RETRACTOR (HAND HELD RETRACTORS)	173
ALLISON (HAND HELD RETRACTORS)	183
ALLISON (HAND HELD RETRACTORS)	184
ALMS (SELF RETAINING RETRACTORS)	196
ADSON (SELF RETAINING RETRACTORS)	200
AUVARD (VAGINAL RETRACTOR)	227
ALEXANDER (CERVICAL BIOPSY FORCEPS)	238
AMINIOTOME (UTERINE CANNULAE)	249
ADSON FRAZIER (SUCTION TUBES)	281
APMUTATION SAW (AMPUTATION INSTRUMENTS)	286
ARMY REEGULATION (AMPUTATION INSTRUMENTS)	286
ADSON (RASPIATORIES)	294
ALLISON (RIB SPREADERS)	341
APPLYING FORCEPS (ATRAUMA BULLDOG CLAMPS)	353
ANEURYSM (ATRAUMA CARDIOVASCULAR FORCEPS)	359
APPLYING FORCEPS (BULLDOG CLAMPS)	395
ADSON (MONOPOLAR CABLES)	404
B	
BARRON (SURGICAL HANDLES)	04
BRAITHWAITE (SKIN GRAFTING KNIVES)	08
BRAUN STADTLER EPISIOTOMY (SCISSORS)	14
BABY METZANBAUM ("TC" SCISSORS)	23
BABY METZENBAUM ("TC" SCISSORS)	29
BONNEY (SERRATED DISSECTING FORCEPS)	39
BICKFORD (SERRATED DISSECTING FORCEPS)	39
BONNEY (TOOTHED DISSECTING FORCEPS)	46
BICKFORD (TOOTHED DISSECTING FORCEPS)	46
BABCOCK ("TC" DISSECTING FORCEPS)	51
BABY - ADSON (DISSECTING & LIGATURE FORCEPS)	52
BABCOCK (TISSUE FORCEPS)	57
BALL AND SOCKET (TOWEL CLAMPS)	64
BACKHAUS (TOWEL CLAMPS)	64
BOZEMANN UTERINE (DRESSING FORCEPS)	67
BOZEMANN UTERINE (DRESSING FORCEPS)	68
BABY - CRILE (HAEMOSTATS FORCEPS)	69
BABY - CRILE (HAEMOSTATS FORCEPS)	70
BIRKETT (HAEMOSTATS FORCEPS)	81
BABY - ADSON (DISSECTING & LIGATURE FORCEPS)	85
BARRAQUER (MICRO NEEDLE HOLDERS)	92
BABY-CRILE-WOOD ("TC" NEEDLE HOLDERS)	102
BAUMGARTNER ("TC" NEEDLE HOLDERS)	102
("TC" NEEDLE HOLDERS)	111
BAUMGARTNER ("TC" NEEDLE HOLDERS)	111
BOWMAN (OPHTHALMOLOGY)	120
BANGERTER (OPHTHALMOLOGY)	124
BRODIE (PROBES)	136
BONNEY (SUTURE INTERUMENTS)	144
BALLANCE (HAND HELD RETRACTORS)	166
BARSKY SKIN HOOK (RETRACTORS)	178
BOWDLER-HENRY RAKE (HAND HELD RETRACTORS)	179
BALFOUR ABDOMINAL (RETRACTORS)	187
BERKELEY ABDOMINAL (SELF RETAINING RETRACTORS)	190
BECKMANN-ADSON (SELF RETAINING RETRACTORS)	200
BAKES (GALL DUCT DILATORS / SCOOPS)	209
BLACKE (CHOLECYSTECTOMY & GALL STONE FORCEPS)	211
BROWN (DRESSING FORCEPS)	229
BROWN (TENACULUM FORCEPS)	230
BONNEY POLYPI (OVUM FORCEPS)	234
BURKE (CERVICAL BIOPSY FORCEPS)	240
BIOPSY CUTTING (CERVICAL BIOPSY FORCEPS)	242
BARNES (UTERINE CANNULAE)	249
BUMM (UTERINE CANNULAE)	250
BARTON (OBSTETRIC INSTRUMENTS)	252
BOERMA (OBSTETRIC INSTRUMENTS)	253
BRAUN (OBSTETRIC MIDWIFERY)	254
BONNEY (HYSTERECTOMY CLUMPS)	260
BARRON HAEMORRHOID (PROCTOLOGY HAEMORRHOIDAL)	269
BLADDER SPATULA (UROLOGY)	273
BARRON (SUCTION TUBES)	282
BELUCCI (SUCTION TUBES)	282
BRISTOW (RASPIATORIES)	295
BURNS (BONE HOLDING FORCEPS)	310
BEYER (BONE RONGEURS)	314
BEYER (BONE RONGEURS)	317
BECK RONGEUR (DISC RONGEURS)	321
BRUNNER (BONE & RIB SHEARS)	330
BURFORD (RIB SPREADERS)	333
BAILEY-BABY (RIB SPREADERS)	341
BAINBRIDGE (ATRAUMA CARDIOVASCULAR FORCEPS)	358
BECK (ATRAUMA CARDIOVASCULAR FORCEPS)	374
BULLDOG CLAMPS (BULLDOG CLAMPS)	395
BUCKET (HOLLOW WEARS)	398
BIPOLAR FORCEPS (BIPOLAR FORCEPS)	399
BIPOLAR FORCEPS (BIPOLAR FORCEPS)	400
BLADES (MONOPOLAR HANDLES, BLADES, NEEDLE, TURNER, SCISSORS)	405
BALL ELECTRODES (QUIVER, FINGER SWITCH PENCILS)	407
C	
COBBETT (SKIN GRAFTING KNIVES)	07
CRAFOORD (SCISSORS)	13
COUNTER SCISSORS (SCISSORS)	20
CANADIAN (SERRATED DISSECTING FORCEPS)	36
CAIRNS (DOTT) (DELICATE DISSECTING FORCEPS)	42
CANADIAN (TOOTHED DISSECTING FORCEPS)	46
CUSHING ("TC" DISSECTING FORCEPS)	49
CUSHING ("TC" DISSECTING FORCEPS)	53
COLLIN TONGUE FORCEPS (TONGUE DEPRESSORS)	61
CUSHING (HAEMOSTATS FORCEPS)	71
CAIRNS (HAEMOSTATS FORCEPS)	72
CRAFOORD (HAEMOSTATS FORCEPS)	72

CRILE (HAEMOSTATS FORCEPS)	72	DISSECTING FORCEPS (SERRATED DISSECTING FORCEPS)	36
CRILE (HAEMOSTATS FORCEPS)	73	DISSECTING FORCEPS (SERRATED DISSECTING FORCEPS)	37
CHAPUT (POIRIER) (TISSUE FORCEPS)	89	DISSECTING FORCEPS (SERRATED DISSECTING FORCEPS)	38
CHAPUT (POIRIER) (TISSUE FORCEPS)	90	DISSECTING FORCEPS (TOOTHED DISSECTING FORCEPS)	43
CASTROVIEJO (MICRO NEEDLE HOLDERS)	92	DENIS BROWNE (SPLINTER FORCEPS)	48
CONVERSE (NEEDLE HOLDERS)	93	DEBAKEY ("TC" DISSECTING FORCEPS)	53
CRILE WOOD (NEEDLE HOLDERS)	94	DUVAL (TISSUE FORCEPS)	58
CRILE MURRAY (NEEDLE HOLDERS)	94	DOYEN (CHILD) (MOUTH GAGS)	59
CASTROVIEJO ("TC" NEEDLE HOLDERS)	100	DOYEN (ADULT) (MOUTH GAGS)	59
CRILE - WOOD ("TC" NEEDLE HOLDERS)	101	DOYEN (TOWEL CLAMPS)	63
CONVERSE ("TC" NEEDLE HOLDERS)	102	DUNHILL (HAEMOSTATS FORCEPS)	78
CRILE - WOOD ("TC" NEEDLE HOLDERS)	102	DERF (NEEDLE HOLDERS)	93
COMBINED SCISSOR ("TC" NEEDLE HOLDERS)	104	DERF ("TC" NEEDLE HOLDERS)	101
CAWTHORNE (PROBES)	138	DEBAKEY ("TC" NEEDLE HOLDERS)	104
CHILDES (SUTURE INTERUMENTS)	144	DEBAKEY ("TC" NEEDLE HOLDERS)	105
CHARNLEY (SUTURE INTERUMENTS)	145	DESCHAMPS (ANEURYSM NEEDLES)	146
CUSHINGS VEIN (HAND HELD RETRACTORS)	160	DESCHAMPS (ANEURYSM NEEDLES)	147
CZERNY (HAND HELD RETRACTORS)	166	DESCHAMPS (ANEURYSM NEEDLES)	148
CANNY RYAL (HAND HELD RETRACTORS)	168	DEAVER (HAND HELD RETRACTORS)	149
CAIRNS "RAKE" (HAND HELD RETRACTORS)	180	DEAVER (HAND HELD RETRACTORS)	150
CAIRNS STRIP (HAND HELD RETRACTORS)	180	DEAVER (HAND HELD RETRACTORS)	151
CRILE (HAND HELD RETRACTORS)	181	DEAVER GRIP (HAND HELD RETRACTORS)	152
CUSHING (HAND HELD RETRACTORS)	181	DEAVER GRIP (HAND HELD RETRACTORS)	153
CAIRNS (HAND HELD RETRACTORS)	181	DURHAM (HAND HELD RETRACTORS)	158
CAIRNS SCALP (SELF RETAINING RETRACTORS)	196	DOYEN (HAND HELD RETRACTORS)	171
CONE (SELF RETAINING RETRACTORS)	197	DOYEN (HAND HELD RETRACTORS)	172
CONE LAMINECTOMY (SELF RETAINING RETRACTORS)	198	DESMARRES (HAND HELD RETRACTORS)	177
CONE LAMINECTOMY (SELF RETAINING RETRACTORS)	198	DAVISON (HAND HELD RETRACTORS)	184
CHARLEY INITIAL INCISION (SELF RETAINING RETRACTORS)	202	DESJARDINS (GALL DUCT PROBES)	208
CHARLEY PIN (SELF RETAINING RETRACTORS)	202	DESJARDINS (GALL DUCT DILATORS / SCOOPS)	209
CHOLANGIOGRAM (CHOLECYSTECTOMY & GALL STONE FORCEPS)	212	DESJARDINS (GALL STONE SCOOPS / FORCEPS)	210
CUSO (VAGINAL SPECULUM)	222	DUCT DISSECTING (CHOLECYSTECTOMY & GALL STONE FORCEPS)	211
CZERNY (PROCTOLOGY)	265	DOYEN (INTESTINAL CLAMPS)	213
CLUTTON URETHRAL SOUND (UROLOGY)	279	DOYEN (INTESTINAL CLAMPS)	214
CHIP SYRINGE (SUCTION TUBES)	284	DOYEN ROBSON (INTESTINAL CLAMPS)	215
CAIRNS SKULL FLAP (BONE LEVERS & ELEVATORS)	287	DOYEN (VAGINAL SPECULUM)	225
COBRA HIP LEVER (BONE LEVERS)	292	DOYEN (OVUM FORCEPS)	234
COLLIER AND MORRIS (BONE SCOOPS)	300	DARTIGUES (UTERINE ELEVATOR FORCEPS)	235
CAPENER CHISELS (OSTEOTOMES, CHISELS & GOUGES)	301	DOYEN (MYOMA INSTRUMENTS)	236
CAPENER OSTEOTOME (OSTEOTOMES, CHISELS & GOUGES)	302	DOUBLE ENDED (UTERINE CURETTES)	245
CAIRNS (BONE RONGEURS)	314	DeLEE (OBSTETRIC INSTRUMENTS)	251
CUSHING (DISC RONGEURS)	321	DEWEY (OBSTETRIC INSTRUMENTS)	253
CAST BENDING FORCEPS (PLASTER CAST)	327	DINGMAN (BONE HOLDING FORCEPS)	312
COOLEY (RIB SPREADERS)	331	DE VILBISS (BONE CUTTING FORCEPS)	326
CASTANEDA (RIB SPREADERS)	334	DE-BAKEY SATINSKY (ATRAUMA BULLDOG CLAMPS)	344
COOLEY (ATRAUMA CARDIOVASCULAR FORCEPS)	351	DE-BAKEY RANKIN (ATRAUMA HEMOSTATIC FORCEPS)	345
COOLEY (ATRAUMA CARDIOVASCULAR FORCEPS)	376	DIETRICH (ATRAUMA CARDIOVASCULAR FORCEPS)	346
COOLEY (VASCULAR DILATORS)	381	DALE (ATRAUMA CARDIOVASCULAR FORCEPS)	347
CASTANEDA (NEONATAL CLAMPS)	389	DE BAKEY (ATRAUMA TISSUE FORCEPS)	352
COOLEY (CAVAL OCCLUSION CLAMPS)	391	DEBAKEY BULLDOG CLAMPS (ATRAUMA BULLDOG CLAMPS)	353
COOLEY (BULLDOG CLAMPS)	392	DE BAKEY (ATRAUMA CARDIOVASCULAR FORCEPS)	356
		DE BAKEY (ATRAUMA CARDIOVASCULAR FORCEPS)	357
		DE BAKEY BAHNSON (ATRAUMA CARDIOVASCULAR FORCEPS)	369
		DE BAKEY BAHNSON (ATRAUMA CARDIOVASCULAR FORCEPS)	371
		DE BAKEY PEAN (ATRAUMA CARDIOVASCULAR FORCEPS)	372
		DE BAKEY (VASCULAR DILATORS)	381
		DE BAKEY-BECK (LIGATURE CARRIERS)	390
			382

D

DRESSING (SCISSORS)	12
DOYEN ABDOMINAL (SCISSORS)	20
DOYEN ABDOMINAL (SCISSORS)	20
DELICATE SCISSORS ("TC" SCISSORS)	23
DEBAKEY VASCULAR ("TC" SCISSORS)	28

INDEX

DE BAKEY (BULLDOG CLAMPS)	396
DESSECTING FORCEPS (MONOPOLAR CABLES)	404
DIATHERMY QUIVER (QUIVER, FINGER SWITCH PENCILS)	407

E

ERGONOMIC (SURGICAL HANDLES)	01
EMMET (SERRATED DISSECTING FORCEPS)	40
EXTRA FINE (DELICATE DISSECTING FORCEPS)	42
EDNA (LORNA) (TOWEL CLAMPS)	63
EDNA (LORNA) (TOWEL CLAMPS)	63
EAST GRINSTEAD (HAND HELD RETRACTORS)	179
ENDOMETRIAL (CERVICAL BIOPSY)	237
EPENDORFER (CERVICAL BIOPSY FORCEPS)	241
ELLIOT (OBSTETRIC INSTRUMENTS)	251
ECHLIN (BONE RONGEURS)	318
EDINBURGH TRAYS (STERILIZATION TRAYS)	397
EPERLE TOE NAIL SCISSORS (NAIL SCISSORS)	408

F

FAVALORO (SCISSORS)	19
FINE (TOOTHED DISSECTING FORCEPS)	46
FEILCHENFEL (SPLINTER FORCEPS)	48
FINE CURVED DISSECTING (DISSECTING & LIGATURE FORCEPS)	54
FERGUSSON ACLAND (MOUTH GAGS)	59
FEATHERSTONE (MOUTH GAGS)	59
FLAT TONGUE DEPRESSOR (TONGUE DEPRESSORS)	60
FORESTER (SPONGE HOLDING FORCEPS)	66
FRASER - ADSON (HAEMOSTATS FORCEPS)	78
FRASER-KELLY (CRILE) (HAEMOSTATS FORCEPS)	78
FICKLING ORAL (HAEMOSTATS FORCEPS)	84
FINE CURVED (DISSECTING & LIGATURE FORCEPS)	86
FINOCCHIETTO ("TC" NEEDLE HOLDERS)	110
FISTULA PROBE (PROBES)	139
FARABEUF (HAND HELD RETRACTORS)	163
FINSON (SELF RETAINING RETRACTORS)	195
FINCH EXCISION (INTESTINAL CLAMPS)	219
FRENCH MODEL PELVIMETER (UTERINE CANNULAE)	249
FOX (DERMATOLOGY INSTRUMENTS)	255
FAURE (PERITONEUM INSTRUMENTS)	258
FEMALE CATHETERS (UROLOGY)	279
FRAZIER (SUCTION TUBES)	281
FINGER SAW (AMPUTATION INSTRUMENTS)	286
FREERB ELEVATOR (RASPATORIES)	294
FARABEUF (RASPATORIES)	296
FICKLING DENTAL (MALLETS)	307
FERGUSSON (BONE HOLDING FORCEPS)	308
FINOCCHIETTO (RIB SPREADERS)	332
FINOCCHIETTO (RIB SPREADERS)	335
FINOCCHIETTO -BABY (RIB SPREADERS)	336
FINOCCHIETTO (RIB SPREADERS)	337
FINOCCHIETTO -MARTIN (RIB SPREADERS)	338

G

GILLIES (TOOTHED DISSECTING FORCEPS)	44
GREY TURNER (HAEMOSTATS FORCEPS)	71
GILLIES (NEEDLE HOLDERS)	95
GILLIES ("TC" NEEDLE HOLDERS)	104
GRAEFE (OPHTHALMOLOGY)	119
GRAEFE (OPHTHALMOLOGY)	122
GWYNNE EVANS TONSIL (DISSECTORS)	142
GILLIES SKIN HOOK (RETRACTORS)	178
GOSSET (RETRACTOR)	188
GOLIGHER (SELF RETAINING RETRACTORS)	190
GELPI VULVA (SELF RETAINING RETRACTORS)	195
GEARY GRANT (CHOLECYSTECTOMY & GALL STONE)	205
GALL DUCT SCISSORS (CHOLECYSTECTOMY & GALL STONE)	207
GRAVE (VAGINAL SPECULUM)	223
GALABIN (UTERINE DILATORS / PROBES)	228
GRAEM ANDERSON (PROCTOLOGY)	264
GABRIEL RECTAL (PROCTOLOGY)	264
GABRIEL METAL AND GLASS (HAEMORRHOIDAL SYRINGES)	271
GUYON (UROLOGY)	272
GILLIES (SUCTION TUBES)	280
GOUGES (OSTEOTOMES, CHISELS & GOUGES)	303
GIGI SAW WITH HANDLE (BONE RONGEURS)	317
GLUCK (BONE & RIB SHEARS)	329
GIERTZ STILLE (BONE & RIB SHEARS)	330
GLOVER (ATRAUMA BULLDOG CLAMPS)	344
GREGORY-SOFT (ATRAUMA BULLDOG CLAMPS)	344
GREGORY (ATRAUMA CARDIOVASCULAR FORCEPS)	248
GLOVER (ATRAUMA CARDIOVASCULAR FORCEPS)	354
GLOVER (ATRAUMA CARDIOVASCULAR FORCEPS)	374

H

HUMBY (SKIN GRAFTING KNIVES)	08
HEGEMANN'S DELICATE (SCISSORS)	15
HEYMANN TURBINECTOMY (DELICATE SCISSORS)	17
HEDGEMAN (SCISSORS)	19
HYSTERECTOMY ("TC" SCISSORS)	27
HUNTER (SPLINTER FORCEPS)	48
HEYWOOD-SMITH TONGUE FORCEPS (TONGUE DEPRESSORS)	61
HALSTEAD MOSQUITO (HAEMOSTATS FORCEPS)	69
HALSTEAD MOSQUITO (HAEMOSTATS FORCEPS)	70
HEISS (HAEMOSTATS FORCEPS)	81
HEANEY (NEEDLE HOLDERS)	95
HALSEY (NEEDLE HOLDERS)	98
HALSEY ("TC" NEEDLE HOLDERS)	101
HALSEY ("TC" NEEDLE HOLDERS)	102
HAGAR-MAYO ("TC" NEEDLE HOLDERS)	103
HAGER-OSLEN ("TC" NEEDLE HOLDERS)	104
THOMSON-WALKER ("TC" NEEDLE HOLDERS)	108
HAENEY ("TC" NEEDLE HOLDERS)	109
HOESEL ("TC" NEEDLE HOLDERS)	113
HAJEK (RETRACTORS)	178
HARRINGTON (HAND HELD RETRACTORS)	182
HARRINGTON - PEMBERTON (HAND HELD RETRACTORS)	183
HENDERSON (SELF RETAINING RETRACTORS)	197
HARVEY-JACKSON LAMINECTOMY (SELF RETAINING RETRACTORS)	199
HAYES (INTESTINAL CLAMPS)	221

INDEX

HEGAR (VAGINAL RETRACTOR)	227
HAWKIN AMBLER (VAGINAL RETRACTOR)	227
HEGAR (UTERINE DILATORS / PROBES)	228
HEYWOOD SMITH (OVUM FORCEPS)	233
HEANY (HYSTERECTOMY CLUMPS)	259
HYSTERECTOMY (HYSTERECTOMY CLUMPS)	262
HERRICK (UROLOGY)	272
HOHMANN (BONE LEVERS)	289
HOHMANN (BONE LEVERS)	290
HOHMANN (BONE LEVERS)	291
HIBBS (OSTEOTOMES, CHISELS & GOUGES)	303
HEATH(MALLETS)	305
HERMANN (MALLETS)	307
HEY GROVES (BONE HOLDING FORCEPS)	309
HARTMANN (BONE RONGEURS)	315
HORSLEY (BONE CUTTING FORCEPS)	324
HENNIG PLASTER (PLASTER CAST)	327
HAIGHT (RIB SPREADERS)	335
HARKEN (ATRAUMA CARDIOVASCULAR FORCEPS)	365
HANDLES (MONOPOLAR HANDLES, BLADES, NEEDLE, TURNER, SCISSORS)	405

I

IRIS (DELICATE SCISSORS)	16
IRIS SCISSORS ("TC" SCISSORS)	22
ISRAEL (HAND HELD RETRACTORS)	167
IRWIN (SELF RETAINING RETRACTORS)	190
I.M.A RETRACTORS (SELF RETAINING RETRACTORS)	202

J

JEFFERSON (DELICATE DISSECTING FORCEPS)	42
JEFFERSON (TOOTHED DISSECTING FORCEPS)	45
JACKSON BURROWS (TOOTHED DISSECTING FORCEPS)	47
JUD-ALLIS (TISSUE FORCEPS)	89
JUD-ALLIS (TISSUE FORCEPS)	90
JAMESON (NEEDLE HOLDERS)	95
JULIAN ("TC" NEEDLE HOLDERS)	115
JOBSON HORNE (PROBES)	138
JOLL THYROID (SELF RETAINING RETRACTORS)	194
JACKSON - BURROWS (SELF RETAINING RETRACTORS)	195
JANSON (SELF RETAINING RETRACTORS)	197
JEFFERSON (SELF RETAINING RETRACTORS)	197
JACOBS (TENACULUM FORCEPS)	232
JONES (RASPATORIES)	296
JACOBSON (BONE SCOOPS)	299
JANSEN-MIDDLETON (BONE RONGEURS)	314
JANSEN (BONE RONGEURS)	315
JANSEN (BONE RONGEURS)	320
JAVID (ATRAUMA CARDIOVASCULAR FORCEPS)	248
JOHNS HOPKINS (BULLDOG CLAMPS)	395
JUG GRADUATED (HOLLOW WEARS)	398
JEWELER (BIPOLAR FORCEPS)	399

K

KILNER (SCISSORS)	15
KILNER (SUPER CUT SCISSORS)	34
KELLY-CRILE (HAEMOSTATS FORCEPS)	73

KELLY (HAEMOSTATS FORCEPS)	74
KELLY HALSTEAD (HAEMOSTATS FORCEPS)	74
KOCHER (HAEMOSTATS FORCEPS)	74
KOCHER (HAEMOSTATS FORCEPS)	75
KILNER (NEEDLE HOLDERS)	95
KILNER ("TC" NEEDLE HOLDERS)	103
KOCHER THYROID (DISSECTORS)	140
KOCHER THYROID (DISSECTORS)	141
KING (DISSECTORS)	141
KELLY (HAND HELD RETRACTORS)	156
KOCHER (HAND HELD RETRACTORS)	159
KOCHER (HAND HELD RETRACTORS)	160
KOCHER (HAND HELD RETRACTORS)	162
KOCHER BONE HOOK (HAND HELD RETRACTORS)	175
KILNER (HAND HELD RETRACTORS)	177
KILNER (RETRACTORS)	178
KILNER ALAE (HAND HELD RETRACTORS)	179
KIRSCHNER RETRACTOR SET (RETRACTORS)	188
KILNER SKIN (SELF RETAINING RETRACTORS)	196
KOCHER (INTESTINAL CLAMPS)	215
KRISTELLE (VAGINAL SPECULUM)	224
KEVORKIAN (CERVICAL BIOPSY FORCEPS)	239
KEVORKIAN (CERVICAL BIOPSY FORCEPS)	240
KIELLAND (OBSTETRICS INSTRUMENTS)	248
KIELLAND-LUIKART (OBSTETRIC INSTRUMENTS)	252
KILNER (DERMATOLOGY INSTRUMENTS)	255
KEYES (DERMATOLOGY INSTRUMENTS)	255
KELLY PROCTOSCOPE (PROCTOLOGY)	264
KIDNEY CLAMP (UROLOGY)	272
KELSEY FRY (MALLETS)	305
KERN-LANE (BONE HOLDING FORCEPS)	313
KIDNEY DISH (HOLLOW WEARS)	398

L

LLOYD DAVIS RECTAL (SCISSORS)	13
LISTER BANDAGE (SCISSORS)	21
LEXER ("TC" SCISSORS)	27
LEXER ("TC" SCISSORS)	31
LANE (TOOTHED DISSECTING FORCEPS)	43
LIGATURE FORCEPS (DISSECTING & LIGATURE FORCEPS)	52
LUCAE ("TC" DISSECTING FORCEPS)	53
LANE (TISSUE FORCEPS)	56
LACK TONGUE DEPRESSOR (TONGUE DEPRESSORS)	60
LLOYD DAVIS (HAEMOSTATS FORCEPS)	75
LIGATURE FORCEPS (DISSECTING & LIGATURE FORCEPS)	85
LAWRENCE (DISSECTING & LIGATURE FORCEPS)	87
LONG CURVED (DISSECTING & LIGATURE FORCEPS)	87
LITTLEWOOD (TISSUE FORCEPS)	90
LITTLEWOOD (TISSUE FORCEPS)	91
LAWRANCE (NEEDLE HOLDERS)	99
LANGENBECK ("TC" NEEDLE HOLDERS)	116
LANGENBECK ("TC" NEEDLE HOLDERS)	117
LAWRANCE ("TC" NEEDLE HOLDERS)	117
LIEBRICH LACHRYMAL (PROBES)	138
LOGAN TURNER (PROBES)	139
LITTAUER (SUTURE INTERUMENTS)	145
LIVER RETRACTORS (HAND HELD RETRACTORS)	157

LANGENBECK (HAND HELD RETRACTORS)	161	MAYO (SUPER CUT SCISSORS)	35
LEMPERT (HAND HELD RETRACTORS)	166	McIndoe (SUPER CUT SCISSORS)	35
LAGEBECK-GREEN (HAND HELD RETRACTORS)	168	MAINGOT INTESTINAL (SERRATED DISSECTING FORCEPS)	40
LLOYD DAVIS (HAND HELD RETRACTORS)	170	MACINDOE (DELICATE DISSECTING FORCEPS)	41
LANGEBECK (HAND HELD RETRACTORS)	175	MICINDOE (TOOTHED DISSECTING FORCEPS)	44
LOGAN (SELF RETAINING RETRACTORS)	196	MUSTARDE (TOOTHED DISSECTING FORCEPS)	47
LAHEY (CHOLECYSTECTOMY & GALL STONE)	205	MICRO SOFT TOUCH RING TIP (SPLINTER FORCEPS)	48
LOWER (CHOLECYSTECTOMY & GALL STONE)	205	MICRO ADSON (DISSECTING & LIGATURE FORCEPS)	52
LANE (INTESTINAL CLAMPS)	216	MERIAM ("TC" DISSECTING FORCEPS)	53
LANG STEVENSON (INTESTINAL CLAMPS)	217	MAGILL CATHETER INTRODUCING (PREPARATION INSTRUMENTS)	62
LANE TWIN ANASTOMOSIS (INTESTINAL CLAMPS)	218	MAYO (TOWEL CLAMPS)	64
LLOYD DAVIS RECTAL OCCLUSION (INTESTINAL CLAMPS)	220	MOYNIHAN (TOWEL CLAMPS)	64
LEECH WILKINSON (CERVICAL BIOPSY FORCEPS)	220	MAYO SAFETY (SAFETY PIN FORCEPS HOLDERS)	65
LEECH-WILKINSON (OBSTETRIC INSTRUMENTS)	246	MAYO (HAEMOSTATS FORCEPS)	75
LUIKART (OBSTETRIC INSTRUMENTS)	252	MOYNIHAN (HAEMOSTATS FORCEPS)	83
LUIKART-BILL (OBSTETRIC INSTRUMENTS)	253	MIXTER (HAEMOSTATS FORCEPS)	83
LLOYD DAVIES (SIGMOIDOSCOPY)	266	MICRO ADSON (DISSECTING & LIGATURE FORCEPS)	85
LLOYD DAVIES (SIGMOIDOSCOPY)	267	MIXTER (DISSECTING & LIGATURE FORCEPS)	87
LLOYD DAVIES (SIGMOIDOSCOPY)	268	MAYO (DUNHILL) (NEEDLE HOLDERS)	93
LISTON (AMPUTATION INSTRUMENTS)	285	MAYO (BAUMGARTNER) (NEEDLE HOLDERS)	97
LANGENBECK (AMPUTATION INSTRUMENTS)	285	MATHIEU (NEEDLE HOLDERS)	98
LANE BONE LEVER (BONE LEVERS & ELEVATORS)	287	MAYO (NEEDLE HOLDERS)	99
LAMBOTE (RASPATORIES)	295	MCPHAILS (NEEDLE HOLDERS)	99
LANGENBECK (RASPATORIES)	295	MASING ("TC" NEEDLE HOLDERS)	101
LEMPERT (BONE SCOOPS)	300	MAYO ("TC" NEEDLE HOLDERS)	107
LAMBOTTE (OSTEOTOMES, CHISELS & GOUGES)	302	MAYO-HEGAR ("TC" NEEDLE HOLDERS)	108
LUCAE (MALLETS)	305	MASSON ("TC" NEEDLE HOLDERS)	110
LANE (BONE HOLDING FORCEPS)	310	MATHIEU ("TC" NEEDLE HOLDERS)	112
LOWMAN (BONE HOLDING FORCEPS)	310	MEYHOEFER (OPHTHALMOLOGY)	123
LEWIN (BONE HOLDING FORCEPS)	311	MYRTLE LEAF PROBE (PROBES)	137
LEWIN (BONE HOLDING FORCEPS)	312	MACDONALD (DISSECTORS)	140
LANE (BONE HOLDING FORCEPS)	313	MICHEL (SUTURE INTERUMENTS)	144
LUER (BONE RONGEURS)	314	MILLIN NEEDLE (SUTURE INTERUMENTS)	145
LEKSELL (BONE RONGEURS)	316	MORRIS (HAND HELD RETRACTORS)	155
LEMPERT (BONE RONGEURS)	320	MIDDELDORPF (HAND HELD RETRACTORS)	158
LISTON (BONE CUTTING FORCEPS)	323	MOYNIHAN (HAND HELD RETRACTORS)	159
LEBSCH (BONE & RIB SHEARS)	330	MCINDOE SKIN HOOK (RETRACTORS)	178
LOVELACE (TISSUE AND ORGAN)	343	MCINDOE SKIN HOOK (HAND HELD RETRACTORS)	179
LELAND JONES (ATRAUMA CARDIOVASCULAR FORCEPS)	357	MILLIN RETROPUBIC (SELF RETAINING RETRACTORS)	194
LEES (ATRAUMA CARDIOVASCULAR FORCEPS)	366	MAYO-ADSON (SELF RETAINING RETRACTORS)	199
LAMBERT - KAY (ATRAUMA CARDIOVASCULAR FORCEPS)	367	MOLLISON (SELF RETAINING RETRACTORS)	201
LOTION BOWEL (HOLLOW WEARS)	398	MIXSTER (CHOLECYSTECTOMY & GALL STONE)	206
		MOYNIHAN (CHOLECYSTECTOMY & GALL STONE)	206
		MOUAT GALL BLADDER (CHOLECYSTECTOMY & GALL STONE)	206
		MILLS (CHOLECYSTECTOMY & GALL STONE)	207
		MOYNIHAN (GALL DUCT PROBES)	208
		McGEE LATERL (VAGINAL SPECULUM)	222
		MATHIEU (VAGINAL SPECULUM)	225
		MODIFEID WERTHEIM (VAGINAL SPECULUM)	225
		MODIFEID DOYEN (VAGINAL SPECULUM)	226
		MARTIN (UTERINE DILATORS / PROBES)	228
		MUSEUX (TENACULUM FORCEPS)	232
		MCLINTOCK (OVUM FORCEPS)	233
		McLEAN-TUCKER-LUIKART (OBSTETRIC INSTRUMENTS)	252
		MIKULICZ (PERITONEUM INSTRUMENTS)	258
		MAINGOT (HYSTERECTOMY CLUMPS)	260

M

MAYO (SCISSORS)	09
MAYO HARRINGTON (SCISSORS)	10
MAYO STILLE (SCISSORS)	10
METZENBAUM (SCISSORS)	11
MCINDOE SCISSORS (SCISSORS)	21
MAYO DISSECTING ("TC" SCISSORS)	23
METZENBAUM ("TC" SCISSORS)	24
MAYO-LEXER ("TC" SCISSORS)	27
MAYO ("TC" SCISSORS)	29
METZENBAUM DELICATE ("TC" SCISSORS)	29
METZENBAUM ("TC" SCISSORS)	30
MAYO-LEXER ("TC" SCISSORS)	31
METZENBAUM ("TC" SCISSORS)	32
MCINDOE SCISSORS ("TC" SCISSORS)	32
METZENBAUM ("TC" SCISSORS)	33
METZENBAUM (SUPER CUT SCISSORS)	35



RUMEL-BELMONT (NERVE HOOKS, TOURNIQUETS) 385
RICHES FORCEPS (MONOPOLAR CABLES) 404

S

SILVER (SKIN GRAFTING KNIVES) 07
STRABISMUS (DELICATE SCISSORS) 16
STEVENS TENOTOMY (DELICATE SCISSORS) 17
SCHUKNECHT WIRE CUTTING (ORAL SCISSORS) 18
SCHUMACHER UMBILICAL (SCISSORS) 21
SURGICAL SCISSORS ("TC" SCISSORS) 22
STRABISMUS SCISSORS ("TC" SCISSORS) 23
SIMS ("TC" SCISSORS) 26
SIMS ("TC" SCISSORS) 32
SIMS ("TC" SCISSORS) 33
ST MARKS (SERRATED DISSECTING FORCEPS) 40
SILCOCK (DELICATE DISSECTING FORCEPS) 42
SILCOCK (TOOTHED DISSECTING FORCEPS) 46
ST MARKS (TOOTHED DISSECTING FORCEPS) 47
S.SHAPED DELICATE (DISSECTING & LIGATURE FORCEPS) 52
SEMKEN ("TC" DISSECTING FORCEPS) 53
SEMKEN ("TC" DISSECTING FORCEPS) 53
STILES (ALLIS-THOMS) (TISSUE FORCEPS) 56
SCHAEDEL (SAFETY PIN FORCEPS HOLDERS) 65
SPENCER WELLS (HAEMOSTATS FORCEPS) 79
SCHNIDT TONSIL (TONSIL ARTERY FORCEPS) 82
S.SHAPED DELICATE (DISSECTING & LIGATURE FORCEPS) 85
SAROT ("TC" NEEDLE HOLDERS) 103
SINUS (PROBES) 137
SYME TONSIL (RETRACTOR) 143
SMALLANEURYSM (ANEURYSM NEEDLES) 146
SYME (ANEURYSM NEEDLES) 146
SIMON (HAND HELD RETRACTORS) 171
SMILLIE (HAND HELD RETRACTORS) 174
SENN-MILLAR (HAND HELD RETRACTORS) 177
ST-BRATS MODEL (HAND HELD RETRACTORS) 182
STERNAL / ABDOMINAL (SELF RETAINING RETRACTORS) 189
SUPRAPUBIC (TROCCARS) 203
SCOOP (GALL STONE SCOOPS / FORCEPS) 210
SETON PRINGLE (INTESTINAL CLAMPS) 210
SCHOEMAKER (INTESTINAL CLAMPS) 217
SIMS (VAGINAL SPECULUM) 223
SIMON (VAGINAL SPECULUM) 226
SIMS (UTERINE DILATORS / PROBES) 228
SCHROEDER (TENACULUM FORCEPS) 230
SCHROEDER (TENACULUM FORCEPS) 231
SOMER (UTERINE ELEVATOR FORCEPS) 235
SHARMAN (CERVICAL BIOPSY) 237
SCHUBERT (CERVICAL BIOPSY FORCEPS) 238
SCHMARCHER (CERVICAL BIOPSY FORCEPS) 239
SIMON (UTERINE SCOOPS & CURETTES) 243
SIMS (UTERINE SCOOPS & CURETTES) 243
SIMS (UTERINE CURETTES) 244
SPACKMANN (GYNECOLOGY INSTRUMENTS) 247
SIMS (UTERINE CANNULAE) 250
SIMPSON (OBSTETRIC INSTRUMENTS) 251
SIMPSON-LUKART (OBSTETRIC INSTRUMENTS) 252
SELLHEIM (OBSTETRIC MIDWIFERY) 254
SCHAMBERG (DERMATOLOGY INSTRUMENTS) 255
SAALFELD (DERMATOLOGY INSTRUMENTS) 255
SAENGER OVUM FORCEPS (GYNECOLOGY INSTRUMENTS) 257
SIMS RECTAL (PROCTOLOGY) 264
ST GORGES SEIZING (HAEMORRHOIDAL LIGATORS) 270
SELF CLEARING (SUCTION TUBES) 283
ST THOMAS (BONE LEVERS & ELEVATORS) 287
SWEDISH MODEL (OSTEOTOMES, CHISELS & GOUGES) 301
SMITH-PETERSON (OSTEOTOMES, CHISELS & GOUGES) 302
SMITH-PETERSON (OSTEOTOMES, CHISELS & GOUGES) 304
SEQUESTUM (BONE HOLDING FORCEPS) 308
SEMB (BONE HOLDING FORCEPS) 312
SYNOVECTOMY RONGEUR (BONE RONGEURS) 315

STILLE-RUSKIN (BONE RONGEURS) 319
SARGENT (BONE RONGEURS) 319
STAMM (BONE CUTTING FORCEPS) 324
STILLE LISTON (BONE CUTTING FORCEPS) 325
STILLE (BONE & RIB SHEARS) 329
SAUERBRUCH (BONE & RIB SHEARS) 330
SANTULLI (ATRAUMA BULLDOG CLAMPS) 344
SIMB (BRONCHUS FORCEPS) 342
SATINSKY (ATRAUMA CARDIOVASCULAR FORCEPS) 364
SUBRAMANIAN (ATRAUMA PEDIATRIC CLAMPS) 367
SEMB (LIGATURE CARRIERS) 390
STERILIZATION TRAY (STERILIZATION TRAYS) 397

T

TOENNIS - ADSON ("TC" SCISSORS) 25
TOENNIS ADSON ("TC" SCISSORS) 30
TREVES (TOOTHED DISSECTING FORCEPS) 43
TROELTSCH (Wide) (SPLINTER FORCEPS) 48
TROELTSCH (Wide) (SPLINTER FORCEPS) 48
TUDICHUM (SPLINTER FORCEPS) 48
TUBING CLAMP (HAEMOSTATS FORCEPS) 84
TUBING CLAMP (TISSUE FORCEPS) 91
TOENNIS ("TC" NEEDLE HOLDERS) 116
TRACHEAL HOOK (HAND HELD RETRACTORS) 182
TURNER WARWICK (SELF RETAINING RETRACTORS) 185
TRAVERS (SELF RETAINING RETRACTORS) 190
TURNER WARWICK (SELF RETAINING RETRACTORS) 195
TRAVERS (SELF RETAINING RETRACTORS) 197
TILLEY LICHTWITZ (TROCCARS) 204
TEALE (TENACULUM FORCEPS) 231
THOMS-GAYLOR (CERVICAL BIOPSY) 237
TISCHLER-MORGAN (CERVICAL BIOPSY FORCEPS) 239
TOWNSEND (CERVICAL BIOPSY FORCEPS) 240
TARNER (OBSTETRIC INSTRUMENTS) 253
TRINER (OBSTETRIC MIDWIFERY) 254
TURNER-WARWICK (UROLOGY) 275
TURNER-WARWICK METAL (UROLOGY) 276
TURNER-WARWICK (UROLOGY) 277
TURNER-WARWICK (UROLOGY) 278
TINKLER (SUCTION TUBES) 280
TUFNOL MALLET (MALLETS) 306
TROTTER (BONE RONGEURS) 310
TUFFIER (RIB SPREADERS) 335
TUBBS (DILATORS) 390
TURNER WARWICK (MONOPOLAR HANDLES, BLADES, NEEDLE, TURNER, SCISSORS) 405

U

UTERINE (SCISSORS) 13
UTERINE (SCISSORS) 14
UTERINE (SCISSORS) 14
US ARMY (HAND HELD RETRACTORS) 169
UTERINE FLUSHING TUBE (OBSTETRIC INSTRUMENTS) 246
URNA (DERMATOLOGY INSTRUMENTS) 255
UMBILICAL DILATOR (GYNECOLOGY INSTRUMENTS) 257

V

VOLKMANN (HAND HELD RETRACTORS) 165
VACUUM EXTRACTION (UTERINE CANNULAE) 249
VERHOEVEN (SUCTION TUBES) 283
VOLKMANN (BONE SCOOPS) 299
VERBRUGGE (BONE HOLDING FORCEPS) 311

W

WATSON (SKIN GRAFTING KNIVES) 07
WOODS TONSIL (ORAL SCISSORS) 18
WHEELER TONSIL (ORAL SCISSORS) 18
WILSON TONSIL (ORAL SCISSORS) 18
WAUGH (DELICATE DISSECTING FORCEPS) 41

WAUGH (TOOTHED DISSECTING FORCEPS)	45
WANGENSTEEN ("TC" DISSECTING FORCEPS)	50
WILSON TONSIL (TONSIL ARTERY FORCEPS)	82
WANGENSTEEN (NEEDLE HOLDERS)	94
WRIGHT (NEEDLE HOLDERS)	95
WARD (NEEDLE HOLDERS)	96
WEBSTER (NEEDLE HOLDERS)	99
WAGENSTEEN ("TC" NEEDLE HOLDERS)	108
WERTHEIM ("TC" NEEDLE HOLDERS)	111
WIRE CUTTER ("TC" NEEDLE HOLDERS)	117
WEBER (OPHTHALMOLOGY)	124
WILDER (OPHTHALMOLOGY)	124
WECKER (OPHTHALMOLOGY)	124
WILDER (OPHTHALMOLOGY)	126
WATSON CHEYNE (DISSECTORS)	140
WALTON (HAND HELD RETRACTORS)	163
WERTHEIM (HAND HELD RETRACTORS)	174
WARDS CHEEK (HAND HELD RETRACTORS)	179
WEISLANDER (SELF RETAINING RETRACTORS)	191
WEISLANDER (SELF RETAINING RETRACTORS)	192
WEISLANDER (SELF RETAINING RETRACTORS)	193
WALACE MODIFIED (SELF RETAINING RETRACTORS)	201
WILSON (TENACULUM FORCEPS)	230
WITTNER (CERVICAL BIOPSY FORCEPS)	239
WRIGLEY (OBSTETRICS INSTRUMENTS)	248
WALTON (DERMATOLOGY INSTRUMENTS)	255
WINTER OVUM FORCEPS (DERMATOLOGY INSTRUMENTS)	256
WERTHEIM (HYSTERECTOMY CLUMPS)	261
WERTHEIM (HYSTERECTOMY CLUMPS)	263
WALTON RECTAL (SIGMOIDOSCOPY)	268
WATSLON JONES (BONE LEVERS)	288
WILLIGER (BONE LEVERS)	292
WILLIGER (BONE LEVERS & RASPATORIES)	293
WILMS (BONE RONGEURS)	316
WARD (BONE CUTTING FORCEPS)	326
WEBER (ATRAUMA CARDIOVASCULAR FORCEPS)	363
WILSON HEY FORCEPS (MONOPOLAR CABLES)	404

Y

YEOWMAN BIOPSY (PROCTOLOGY HAEMORRHOIDAL)	269
YANKAUER (SUCTION TUBES)	280

Z

ZWEIFIL ("TC" NEEDLE HOLDERS)	114
ZOELLNER (SUCTION TUBES)	284
ZAUFAL-JANSEN (BONE RONGEURS)	318



SURGICAL

Instruments Catalogue



Design & Printed:
House of Catalogue
Tel: 052-4584686, 4612006, 7
www.houseofcatalogue1.com

SURGICAL INSTRUMENTS